

TRES









2021







Shower systems Sistemi doccia Sprchové systémy

-  **Concealed thermostats, easy to install.**
Miscelatori termostatici a incasso facili da montare.
Podomítkové termostaty se snadnou montáží.
-  **Electronic thermostat control.**
Controllo elettronico termostatico.
Elektronická termostatická regulace.
-  **High-performance mixer taps.**
Miscelatori monocomando a alte prestazioni.
Vysoce výkonné jednopákové baterie.
-  **Mixer taps with 3 water outlet routes.**
Miscelatori monocomando a 3 vie di uscita dell'acqua.
Jednopákové ovládací baterie se 3 výstupy vody.







Characteristics Caratteristiche Vlastnosti

-  **New.**
Novità.
Novinka.
-  **Automatic drain included.**
Scarico automatico incluso.
Automatická výpust v ceně.
-  **Telescopic shower bar.**
Scarico automatico incluso.
Teleshopická sprchová tyč.
-  **Suitable for people with physical disabilities.**
Indicato per persone con disabilità fisiche.
Určeno pro osoby s fyzickým handicapem.
-  **Works with electric current.**
Funziona mediante alimentazione elettrica.
Napájení z elektrické sítě.
-  **Works with battery power.**
Funziona mediante alimentazione con batterie.
Napájení z elektrické baterie.
-  **Brass shower head.**
Soffione in ottone.
Kropítko z mosazi.
-  **Stainless steel shower head.**
Soffione in acciaio inox.
Kropítko z nerezové oceli.
-  **Brass hand shower.**
Doccia a mano in ottone.
Ruční sprcha z mosazi.
-  **Stainless steel hand shower.**
Doccia a mano in acciaio inox.
Ruční sprcha z nerezové oceli.

Spare parts Ricambi Náhradní díly

-  **Cartridge (spare part reference).**
Cartuccia (numero di riferimento del ricambio).
Kartuše (referenční číslo náhradního dílu).
-  **Frame (spare part reference).**
Montatura (numero di riferimento del ricambio).
Kohoutek (referenční číslo náhradního dílu).
-  **Distributor (spare part reference).**
Distributore (numero di riferimento del ricambio).
Směšovací kartuše (referenční číslo náhradního dílu).
-  **Cartridge + Handle (spare part reference).**
Cartuccia + Manopola (numero di riferimento del ricambio).
Kartuše + ovládací kohoutek (referenční číslo náhradního dílu).

Technology Tecnologia Technologie

-  **Shower with Chromotherapy system.**
Doccia con sistema di Cromoterapia.
Sprcha s chromoterapií.
-  **Cartridge Instant 77®.**
Cartuccia Instant 77®.
Kartuše Instant 77®.
-  **Cartridge Instant 57®.**
Cartuccia Instant 57®.
Kartuše Instant 57®.
-  **Touch-Cool®: The surface of the tap is always cold.**
Touch-Cool®: La superficie del rubinetto è sempre fredda.
Touch-Cool®: Povrch baterie je vždy chladný.
-  **Easy-Clean®: Easy access to and maintenance of the cartridge.**
Easy-Clean®: Accesso e manutenzione facile della cartuccia.
Easy-Clean®: Snadný přístup ke kartuši, snadná údržba.
-  **Cold-Tres®: The tap always opens with cold water.**
Cold-Tres®: Il rubinetto si apre sempre con l'acqua fredda.
Cold-Tres®: Po otevření začne z ventilu vytekat vždy nejprve studená voda.
-  **Tres-Duo®: The middle position halves the consumption.**
Tres-Duo®: Nella posizione intermedia si consuma la metà.
Tres-Duo®: Ve střední poloze je spotřeba poloviční.

Indications Indicazioni Pokyny

-  **Spout swivel angle.**
Angolo di rotazione della canna.
Úhel otočení ramínka.
-  **Shower head functions (litres/minute).**
Funzioni di un soffione (litri/minuto).
Funkce kropítka (l/min).
-  **Hand shower functions (litres/minute).**
Funzioni di una doccia a mano (litri/minuto).
Funkce ruční sprchy (l/min).
-  **Jet functions (litres/minute).**
Funzioni delle bocchette (litri/minuto).
Funkce trysek (l/min).

Certifications Certificati Osvědčení

-  **NF (France).**
-  **AENOR (Spain).**
-  **Environmental Quality Guarantee of the Government of Catalonia.**
-  **BELGAQUA (Belgique).**

TRES

2021

**The products shown in this catalogue may undergo slight modifications due to design demands, always to the item's benefit.
The prices in this catalogue are recommended retail prices and do not include IVA (VAT).
Given the possibility of printing errors, the revised and definitive prices are always shown on TRES' website.
Please consult the website for product availability.
You can keep up to date with TRES's news or see if a product has been discontinued on this website.**

**I prodotti del catalogo possono subire qualche modifica per rispondere a esigenze di design, sempre a vantaggio del prodotto.
I prezzi del catalogo sono raccomandati per la vendita al pubblico, IVA non inclusa.
Per evitare eventuali errori di stampa, i prezzi definitivi vengono sempre mostrati sulla pagina web di TRES.
Per sapere la disponibilità dei prodotti, consultare la pagina web.
La pagina web permette di essere sempre aggiornati sulle novità di TRES o di verificare se un prodotto è fuori catalogo.**

*Zobrazené výrobky v tomto katalogu mohou doznat drobných úprav v důsledku designových požadavků. Pokud se tak stane, je to vždy ve prospěch produktu.
Ceny uvedené v tomto katalogu jsou doporučené maloobchodní prodejní ceny bez DPH.
Vzhledem k možným tiskovým chybám rozhodují vždy ceny uvedené na internetových stránkách TRES, které mají definitivní platnost.
Údaje o dostupnosti výrobků získáte na našich internetových stránkách.
Právě zde máte z první ruky přístup k novinkám TRES a k informacím, které produkty byly ze sortimentu vyřazeny.*

Bathroom

Bagno

Koupelna



41
Slim exclusive



57
Cuadro exclusive



71
Study exclusive



9
Loft Colors



109
Project-tres



127
Tres-Clasic



417
Cuadro-tres



441
Max-tres



463
Loft-tres



477
Class-tres



489
Lex-tres



507
Alplus



519
Flat-tres



537
Fitted with timers / Electronic
Temporizzate / Elettroniche
S časovačem / Elektronické



151
Bathroom accessories
Accessori da bagno
Doplnky do koupelny



545
Bidets WC
Bidet WC
Bidety WC

Shower
Doccia
Sprcha



183
Block System



245
Shower Technology



281
Mono-Term



293
3V



335 / 355
Thermostatically-controlled sets
Gruppi termostatici
Termostatické soupravy



368
Thermostatic
Termostatiche
Termostatické



378
Shower columns
Colonne doccia
Sprchové panely



383
Mixer taps
Monocomandi
Baterie



407
Deck-mounted bathtubs
Bordovasca
Vany s prodlouženým pultem



306
Shower heads
Soffioni
Hlavové sprchy



324 / 554
Sliding bar
Barra di scorrimento
Posuvná tyč



325 / 557
Shower kit
Kit per doccia
Sprchová souprava



326 / 567
Hand showers / Jets
Doccini / Getti
Ruční sprchy / Hydromasážní hlavice



331 / 575
Supports / Elbows
Supporti / Gomiti
Podstavce / Kolena



330 / 572
Hoses
Flessibili
Hadice

Tap supplements
Complementi di rubinetteria
Příslušenství



164 / 581
Valve
Valvola
Ventil



165 / 588

Bath drain
Scarico vasca
Vanový sifon



166 / 589

Siphon
Sifone
Sifon



591

Cover plate
Rosone
Krycí rozeta



167 / 591

Spout
Erogatore Vasca
Výtoková hubice



593

Adjustment key
Chiave di regolazione
Uzavírací ventil



167 / 594

Elbow adaptor
Gomito adattatore
Rohový ventil



596

Outlet valve
Valvola di svuotamento
Vypouštěcí ventil



597

Flow restrictors
Limitatori di flusso
Omezovače průtoku



598

Aerator
Ariatore
Perlátor



600

Anti-chlorine filter
Filtro anticloro
Filtr na chlor pro sprchu

Kitchen Cucina Kuchyně



170 / 532

Mixer taps
Monocomando
S jednopákovým mechanismem



176

Flexible hose
Canna flessibile
Flexibilní ramínko



177 / 533

Extendable hose
Canna estraibile
Odnímatelné ramínko



179

Folding kitchen taps
Reclinabile
Dřezová sklopná baterie



535

For water treatment
Sistema trattamento acqua
Dřezová baterie k úpravě vody





































180

Electronic kitchen taps
Elettronica
Dřezové elektronické baterie



181

Dual-control
Doppio comando
Dřezová kohoutková baterie

Slim exclusive			Cuadro-tres
Cuadro exclusive			Max-tres
Study exclusive			Loft-tres
Loft colors			Class-tres
Project-tres			Lex-tres
Tres-Clasic			Alplus
Bathroom accessories Accessori da bagno <i>Doplňky do koupelny</i>			Flat-tres
Tap supplements (Exclusive) Complementi di rubinetteria (Exclusive) <i>Příslušenství (Exclusive)</i>			Kitchen (Selection) Cucina (Selection) <i>Kuchyně (Selection)</i>
Kitchen (Exclusive) Cucina (Exclusive) <i>Kuchyně (Exclusive)</i>			Block System
Block System			Shower Technology
Shower Technology			Mono-Term
Mono-Term			Bidets WC Bidet WC <i>Bidety WC</i>
3V			Bath space (Selection) Programma per docce (Selection) <i>Vanový prostor (Selection)</i>
Bath space (Exclusive) Programma per docce (Exclusive) <i>Vanový prostor (Exclusive)</i>			Thermostatically-controlled sets Gruppi termostatici <i>Termostatické soupravy</i>
Thermostatically-controlled sets Gruppi termostatici <i>Termostatické soupravy</i>			Thermostatic Termostatiche <i>Termostatické</i>
Thermostatic Termostatiche <i>Termostatické</i>			Mixer taps Monocomandi <i>Batterie</i>
Mixer taps Monocomandi <i>Batterie</i>			List of product references Lista di codici articoli <i>Seznam referencí</i>

ref.



JAUME TRES *founder | fondatore | zahladatel*



Every invention has its origin
Qualsiasi invenzione ha la sua origine
Každý vynález má svůj původ



**The greatest ideas come
from the vineyards...**

Dai vigneti nascono grandi idee...

Na vinicích se rodí velké nápady...

TRES began operating in 1968 in the Penedès wine-growing region.

The company's foray into the manufacture of tapware started when its founder, Jaume Tres, turned the wine sector upside down with a new tap for casks with improved airtightness.

This new tap prevented wine loss and stopped unnecessary air from entering, thus preventing the wine from foaming when released.

TRES' industrial spirit emerged from its origins creating taps for wine barrels, followed by years of experience inventing and designing products that create the best water experiences.

TRES inizia la sua attività nel 1968 nella zona viticola del Penedès.

Il salto nel mondo della rubinetteria fu fatto quando il fondatore, Jaume Tres, rivoluzionò il settore vinicolo con un nuovo rubinetto per la botte che migliorava la chiusura ermetica.

Il nuovo rubinetto evita la fuoriuscita del vino, l'ingresso dell'aria ed elimina la schiuma.

Lo spirito industriale di TRES nasce dalla creazione dei rubinetti per le botti del vino per dare poi vita a un lungo percorso di creazione e progettualità e alle migliori esperienze con l'acqua.

Společnost TRES zahájila svou činnost v roce 1968 v katalánské vinařské oblasti Penedès.

Průnik firmy do sektoru vodovodních baterií začal v okamžiku, kdy její zakladatel, Jaume Tres, rozpoutal ve vinařském sektoru revoluci. Jeho nové kohoutky na sudy s vínem zlepšovaly hermetické uzavření.

Nový kohoutek eliminuje pěnu při vypouštění vína, zabraňuje úniku vína a nežádoucímu pronikání vzduchu do sudu.

Průmyslový duch společnosti TRES a dlouholetá cesta lemovaná vynálezy a návrhy, které daly vznikl těm nejlepším zážitkům se vším, co se týká vody, vyšly z výroby kohoutků na sudy s vínem.





TRES manufactures accessible products in which design and experience are the focal points, all while improving water consumption.

TRES fabbrica prodotti accessibili in cui il design e l'esperienza sono il pilastro fondamentale e favoriscono un consumo responsabile dell'acqua.

TRES wytwarza dostępne produkty, w których filarem są wzornictwo i doświadczenie. Dzięki nim zużycie wody jest bardziej odpowiedzialne.



**Designed, created and
developed by TRES**

**Pensato, creato
e sviluppato a TRES**

**Vymyšlené, vytvořené
a vyvinuté v TRES**

In order to ensure the maximum quality of its products, TRES controls the entire manufacturing process in its own facilities, from the conception of the idea to turning that idea into a reality.

TRES' spirit is on full display in every one of its taps, which are carefully designed and feature the latest technology to guarantee you a product that is unique, cutting-edge and functional, with a wide range of solutions for those who are looking for comfort in their home.

Per assicurare la massima sicurezza dei suoi prodotti, TRES controlla l'intero processo di fabbricazione, dal concepimento dell'idea al risultato finale.

Lo spirito di TRES è presente in ogni rubinetto, dalla cura dell'estetica alle innovazioni tecnologiche applicate, e offre un prodotto unico, attuale e funzionale con numerose soluzioni per tutte le persone che cercano il comfort.

Aby společnost TRES zajistila tu nejvyšší kvalitu svých výrobků, kontroluje celý výrobní proces ve svém závodě, od konceptu nápadu až po jeho realizaci.

Duch společnosti TRES se prolíná každou vodovodní baterií, odráží se v jejím designu, zdokonaluje technologii, a nabízí tak jedinečný, aktuální a funkční produkt se širokou škálou řešení pro všechny, kteří hledají pohodlí.



By your side, for users and professionals

Al tuo fianco, come operatore e come professionista

Vaše podpora, pro uživatele i profesionály

TRES' website is designed for you to effortlessly immerse yourself in the brand's universe.

In its immense catalogue, which is constantly being updated, you'll be able to find the tap of your dreams and discover the endless possibilities that TRES has to offer for your bathroom and kitchen.

TRES' website: a professional's best friend. Our online store allows clients to make quick purchases, see stock levels in real time, resolve any technical doubts, see their order history and access a personal area that contains all the information that they need to know.

Il sito web di TRES raccoglie tutti i nostri prodotti e offre un'esperienza unica nell'universo della marca.

Nel catalogo, sempre aggiornato, è possibile trovare il rubinetto che soddisfa esattamente le tue esigenze e conoscere tutte le soluzioni di TRES per il bagno e la cucina.

Per i professionisti, il sito web è il più grande alleato. L'acquisto online per i nostri clienti è più veloce, specifica le scorte dei prodotti, risolve i dubbi tecnici, permette di vedere la cronologia degli ordini e offre un'area personale con le informazioni necessarie.

Webová stránka TRES je koncipována tak, abyste měli po ruce vše potřebné a mohli se ponořit do světa značky.

V našem rozsáhlém, stále aktualizovaném katalogu najdete vodovodní baterii, která přesně odpovídá Vaším očekáváním, a objevíte veškeré možnosti, které TRES nabízí pro koupelny a kuchyně.

Pro profesionály je tento web skutečným spojencem. Nakupování on-line je pro naše zákazníky rychlejší, podrobně odráží stav produktů na skladu, může zodpovědět vaše technické otázky, máte možnost prohlížet si historii objednávek a nabízí osobní zónu se všemi potřebnými informacemi.



www.tresgriferia.com

TENEMOS EL GRIFO QUE TE GUSTA

Te guiamos paso a paso para encontrar el producto que encaja con tus necesidades

[Ir al selector de productos](#)



LOS ACABADOS
DIVERSOS



SHOWER TECHNOLOGY, LA
DUCHA TÁCTIL DE FÁCIL
INSTALACIÓN

[Conoce esta tecnología >](#)



ESTILO ELEGANTE EN
CUALQUIER BAÑO

[Descubre la serie Tres-Clasic >](#)



Special finishes

Finiture speciali

Speciální provedení

	Slim exclusive	Cuadro exclusive	Study exclusive	Loft colors	Project-tres	Tres-Classic	Cuadro-tres	Max-tres	Loft-tres	Class-tres	Lex-tres	Alplus	Flat-tres	Fitted with timers	Electronic	Block System	Shower Technology	Mono-Term	3V	Showers	Thermostatic	Bath accessories	Kitchen	Supplements
	•		•		•	•	•	•	•	•	•	•	•	•	•	•	•	•	•	•	•	•	•	•
NM	•	•	•	•	•											•	•	•	•	•	•	•	•	•
BM	•	•	•	•	•											•	•	•	•	•	•	•	•	•
AC	•	•	•	•	•											•	•	•	•	•	•	•	•	•
KM			•		•																			•
KMB			•		•																			•
OR	•	•	•	•	•	•										•			•	•		•	•	•
OM	•	•	•	•	•											•			•	•		•	•	•
OP			•		•																			•
LV							•													•			•	•
LM							•													•			•	•
AM				•																•	•		•	
NA				•																•	•		•	
RO				•																•	•		•	
VI				•																•	•		•	
FU				•																•	•		•	
VE				•																•	•		•	
NE	•	•		•												•				•	•		•	
BL	•	•		•												•				•	•		•	
TAM			•													•				•				•
TNA			•													•				•				•
TRO			•													•				•				•
TVI			•													•				•				•
TFU			•													•				•				•
TVE			•													•				•				•
TNE			•													•				•				•
TBL			•													•				•				•



Thermostatically-controlled sets

Gruppi termostatici

Termostatické soupravy



Reference Riferimento Číslo výrobku	20219501	107395	00739504	21139501	20539501	00719501	20010501
Page Pagina Strana	338	339	339	340	340	339	342
Available finishes Finiture disponibili Dostupné povrchové úpravy							
Cartridge Cartuccia Kartuše	Instant 77	Instant 77	Instant 77	Instant 77	Instant 77	Instant 77	Instant 77
Technology Tecnologia Technologie	Touch-Cool	Touch-Cool	Touch-Cool	Touch-Cool	Touch-Cool	Touch-Cool	Touch-Cool
Telescopic Colonne telescopiche Teleskopicky	-	-	-	-	-	650 / 1170	650 / 1170
Quality certificates Certificati di qualità Certifikáty jakosti		-	-				
Shower head Soffione Hlavová sprcha	300x200	300x300	300x200	300x300	250x250	300x300	220x200
Manufacturing material Materiale di fabbricazione Výrobní materiál	Stainless steel Acciaio inossidabile Nerezová ocel	Brass Ottone Mosaz	Stainless steel Acciaio inossidabile Nerezová ocel	Brass Ottone Mosaz	-	Brass Ottone Mosaz	-
Water flow Flusso Průtok	12	11		11		11	15
Hand showers Doccino Ruční sprška	✓	✓	✓	✓	✓	✓	✓
Manufacturing material Materiale di fabbricazione Výrobní materiál	Brass Ottone Mosaz	Brass Ottone Mosaz	Brass Ottone Mosaz	Brass Ottone Mosaz	-	Brass Ottone Mosaz	-
Number of functions Numero di funzioni Počet funkcí	1	1	1	1	1	1	1
Water flow Flusso Průtok	9,5	9,5	9,5	12	9,5	9,5	13



20019503	20019502	21139502	20538501	20538502	20238501	00738501	107964	06138501
342	342	341	341	341	343	343	343	345
Instant 77	Instant 77	Instant 77			Instant 77	Instant 77	Instant 77	Instant 77
Touch-Cool	Touch-Cool	Touch-Cool			Touch-Cool	Touch-Cool	Touch-Cool	Touch-Cool
650 / 1170	650 / 1170	650 / 1170			-	-	-	-
250x250	250x250	300x300	250x250	250x250	300x200	250x250	250x250	Ø300
Stainless steel Acciaio inossidabile Nerezová ocel	Stainless steel Acciaio inossidabile Nerezová ocel	Brass Ottone Mosaz	-	Stainless steel Acciaio inossidabile Nerezová ocel	Stainless steel Acciaio inossidabile Nerezová ocel	-	-	Brass Ottone Mosaz
-	-	11		-	12	11	11	11
120x120	120x120	✓	✓	120x120	✓	✓	✓	✓
-	-	Brass Ottone Mosaz	-	-	Brass Ottone Mosaz	Brass Ottone Mosaz	Brass Ottone Mosaz	Brass Ottone Mosaz
3	3	1	1	3	1	1	1	1
-	-	9,5	12	-	9,5	9,5	9,5	9,5



Reference Riferimento <i>Číslo výrobku</i>	06339301	06139301	20539502	06321101	26121001	06121001	20439501	20439503
Page Pagina <i>Strana</i>	345	344	340	345	344	344	357	358
Available finishes Finiture disponibili <i>Dostupné povrchové úpravy</i>								
Cartridge Cartuccia <i>Kartuše</i>	✓	Instant 77		✓	Instant 77		Instant 57	
Technology Tecnologia <i>Technologie</i>	Touch-Cool		Touch-Cool	Touch-Cool		Touch-Cool		-
Telescopic Colonne telescopiche <i>Teleskopicky</i>	-	-		650 / 1170	800 / 1200	650 / 1170	-	
Quality certificates Certificati di qualità <i>Certifikáty jakosti</i>								
Shower head Soffione <i>Hlavová sprcha</i>	Ø300	Ø300	250x250	Ø300	Ø300		250x250	250x250
Manufacturing material Materiale di fabbricazione <i>Výrobní materiál</i>	Brass Ottone <i>Mosaz</i>	Brass Ottone <i>Mosaz</i>	Stainless steel Acciaio inossidabile <i>Nerezová ocel</i>	Brass Ottone <i>Mosaz</i>	Brass Ottone <i>Mosaz</i>		-	Stainless steel Acciaio inossidabile <i>Nerezová ocel</i>
Water flow Flusso <i>Průtok</i>	11	11	-	11	11		11	-
Hand showers Doccino <i>Ruční sprška</i>	✓	✓	120x120	✓	✓	Ø100	80x80	120x120
Manufacturing material Materiale di fabbricazione <i>Výrobní materiál</i>	Brass Ottone <i>Mosaz</i>	Brass Ottone <i>Mosaz</i>	-	Brass Ottone <i>Mosaz</i>	Brass Ottone <i>Mosaz</i>	-	-	-
Number of functions Numero di funzioni <i>Počet funkcí</i>	1	1	3	1	1	1	1	3
Water flow Flusso <i>Průtok</i>	9,5	9,5	-	9,5	9,5		15	-



190213	190214	19021402	19021302	20438701	20438702	20438712	20438703	20438704	20438713	190385	20438501	20438503	
357	359	360	357	361	358	361	361	358	362	365	364	364	
✓		✓		Instant 57			Instant 57			Instant 77	Instant 57		
Touch-Cool		Touch-Cool		-			-			-			
650 / 1170		650 / 1170	660 / 1183	-			650 / 1170			-			
		-									-		
250x250	Ø250	Ø250	250x250	Ø250	250x250	Ø250	Ø250	250x250	Ø250	Ø225	Ø200	Ø250	
-		Stainless steel Acciaio inossidabile Nerezová ocel		-		Stainless steel Acciaio inossidabile Nerezová ocel	-		Stainless steel Acciaio inossidabile Nerezová ocel	-	-	Stainless steel Acciaio inossidabile Nerezová ocel	
11		-		11			-		11		-	12	-
✓	Ø100	Ø100	120x120	Ø80	80x80	Ø100	Ø80	80x80	Ø100	Ø100	Ø80	Ø100	
Brass Ottone Mosaz	-	-	-	-	-	-	-	-	-	-	-	-	
1	5	1	3	1	1	1	1	1	1	5	1	1	
9,5	16/16,5 15,5/16/11	-	-	15,5	15	-	15,5	15	-	16/16,5 15,5/16/11	15,5	-	



Reference Riferimento <i>Číslo výrobku</i>	18138502	18138503	20438708	181385	181386	190387	190388
Page Pagina <i>Strana</i>	359	356	359	360	360	366	366
Available finishes Finiture disponibili <i>Dostupné povrchové úpravy</i>							
Cartridge Cartuccia <i>Kartuše</i>	Instant 77	Instant 57		✓		Instant 77	Instant 77
Technology Tecnologia <i>Technologie</i>	Touch-Cool	-		Touch-Cool		-	-
Telescopic Colonne telescopiche <i>Teleskopicky</i>		-		-		-	-
Quality certificates Certificati di qualità <i>Certifikáty jakosti</i>	-				-		
Shower head Soffione <i>Hlavová sprcha</i>	Ø250	250x250	250x250	Ø250	Ø250	Ø250	Ø250
Manufacturing material Materiale di fabbricazione <i>Výrobní materiál</i>	Stainless steel Acciaio inossidabile <i>Nerezová ocel</i>		-	-		-	-
Water flow Flusso <i>Průtok</i>	-	-	11	11	12	11	11
Hand showers Doccino <i>Ruční sprška</i>	Ø100	120x120	107x107	Ø100	Ø80	Ø100	Ø100
Manufacturing material Materiale di fabbricazione <i>Výrobní materiál</i>	-	-	-	-	-	-	-
Number of functions Numero di funzioni <i>Počet funkcí</i>	1	3	3	5	1	5	5
Water flow Flusso <i>Průtok</i>	-	-	-	16/16,5 15,5/16/11	15,5	16/16,5/15,5/16/11	16/16,5/15,5/16/11



00716402	20419602	09018602	183395	06216402	20231201	00731201	21131201	20531201
362	363	364	363	362	346	346	346	347

Instant 77	Instant 57	Instant 77	-	Instant 77	Instant 77	Instant 77
Touch-Cool	-	-	Touch-Cool	Touch-Cool	Touch-Cool	Touch-Cool
-	-	-	-	-	1330 / 1850	1330 / 1850

-	-	-	-	-	300x200	300x300	300x300	250x250
-	-	-	-	-	Stainless steel Acciaio inossidabile Nerezová ocel	Brass Ottone Mosaz	Brass Ottone Mosaz	-
-	-	-	-	-	12	11	11	-

✓	Ø80	Ø100	Ø82	Ø100	✓	✓	✓
Brass Ottone Mosaz	-	-	-	-	Brass Ottone Mosaz	Brass Ottone Mosaz	-
1	1	5	3	1	1	1	1
9,5	15,5	16/16,5 15,5/16/11	11/8/6	10	9,5	9,5	12



Reference Riferimento Číslo výrobku	26231201	06231201	06331201	20031201	20238502	00738502	06138502
Page Pagina Strana	348	347	348	347	348	349	349
Available finishes Finiture disponibili Dostupné povrchové úpravy							
Cartridge Cartuccia Kartuše	Instant 77	Instant 77	Instant 77	Instant 77	Instant 77	Instant 77	Instant 77
Technology Tecnologia Technologie	Touch-Cool	Touch-Cool	Touch-Cool	Touch-Cool	Touch-Cool	Touch-Cool	Touch-Cool
Telescopic Colonne telescopiche Teleskopicky	1330 / 1850	1330 / 1850	1330 / 1850	1330 / 1850	-	-	-
Quality certificates Certificati di qualità Certifikáty jakosti							
Shower head Soffione Hlavová sprcha	Ø300	Ø300	Ø300	220x220	300x200	250x250	Ø300
Manufacturing material Materiale di fabbricazione Výrobní materiál	Brass Ottone Mosaz	Brass Ottone Mosaz	Brass Ottone Mosaz	-	Stainless steel Acciaio inossidabile Nerezová ocel	-	Brass Ottone Mosaz
Water flow Flusso Průtok	11	11	11	15	12	11	11
Hand showers Doccino Ruční sprška	✓	Ø100	✓	✓	✓	✓	✓
Manufacturing material Materiale di fabbricazione Výrobní materiál	Brass Ottone Mosaz	-	Brass Ottone Mosaz	-	Brass Ottone Mosaz	Brass Ottone Mosaz	Brass Ottone Mosaz
Number of functions Numero di funzioni Počet funkcí	1	1	1	1	1	1	1
Water flow Flusso Průtok	9,5	9,5	9,5	13	9,5	9,5	9,5



06217402	06217402	183398
367	367	367
Instant 77	Instant 77	-
Touch-Cool	Touch-Cool	Touch-Cool
-	-	-
		-
-	-	-
-	-	-
-	-	-
✓	Ø80	Ø82
Brass Ottone Mosaz	-	-
1	1	3
9,5	15,5	11/8/6



Kitchen taps

Miscelatori da cucina

Kuchyňské baterie



Reference Riferimento Číslo výrobku	106486	130496	106440	107440	130497
Page Pagina Strana	170	170	171	171	171
Available finishes Finiture disponibili Dostupné povrchové úpravy					
Cold-opening Azionamento dell'acqua fredda Otvor pro studenou vodu		-	-	-	-
50% water flow Flusso al 50% Průtok na 50%	-	-	-	-	-
Quality certificates Certificati di qualità Certifikáty jakosti	-	-	-	-	-
Height Altezza Výška	300 mm	305 mm	270 mm		367 mm
Rotation angle Angolo di rotazione Úhel kohoutku	360°	360°	360°		360°
Function Funzionalità Funkcionalita	-	-	-		-



130498	20548601	06248801	20044001	162435	162436	181436	130336
170	172	172	173	173	173	532	173
-						-	-
-	-	-	-	-	-	-	-
-	-	-	-	-	-	-	-
367 mm	298 mm	302 mm	310 mm	310 mm	304 mm	286 mm	
360°	360°	360°	360°	360°	360°	360°	
-	-	-	-	-	-	-	-



Reference Riferimento Číslo výrobku	162541	162441	162440	162442	183341	181341	162540	181540	20544001	06254201
Page Pagina Strana	173	532	175	532	532	532	174	532	174	174
Available finishes Finiture disponibili Dostupné povrchové úpravy										
Cold-opening Azionamento dell'acqua fredda Otvor pro studenou vodu		-	-	-	-	-				
50% water flow Flusso al 50% Průtok na 50%	-	-	-	-	-	-	-	-	-	-
Quality certificates Certificati di qualità Certifikáty jakosti	-	-	-	-		-	-	-	-	-
Height Altezza Výška	350 mm	426 mm	350 mm	350 mm	351 mm	450 mm	417 mm	417 mm	418 mm	418 mm
Rotation angle Angolo di rotazione Úhel kohoutku	360°	360°	360°	360°	360°	360°	360°	360°	360°	360°
Function Funzionalità Funkcionalita	-	-	-	-	-	-	-	-	-	-



Reference Riferimento Číslo výrobku	106437	162438	181438	162437	181437	114444	187444
Page Pagina Strana	177	177	533	177	533	178	178
Available finishes Finiture disponibili Dostupné povrchové úpravy							
Cold-opening Azionamento dell'acqua fredda Otvor pro studenou vodu		-	-	-	-	-	
50% water flow Flusso al 50% Průtok na 50%	-	-	-	-	-	-	-
Quality certificates Certificati di qualità Certifikáty jakosti							
Height Altezza Výška	300 mm	315 mm	293 mm	370 mm	370 mm	419 mm	419 mm
Rotation angle Angolo di rotazione Úhel kohoutku	360°	360°	360°	360°	360°	360°	360°
Function Funzionalità Funkcionalita	Extendable hose Canna estraibile Odnímatelné ramínko	Extendable hose (2 functions) Canna estraibile (2 funzioni) Odnímatelné ramínko (2 fun.)	Extendable hose Canna estraibile Odnímatelné ramínko	Extendable hose Canna estraibile Odnímatelné ramínko	Extendable hose Canna estraibile Odnímatelné ramínko	Extendable hose Canna estraibile Odnímatelné ramínko	Extendable hose Canna estraibile Odnímatelné ramínko





20044002	24234101	24244101	00648701	20548702	03048701	06248702
174	175	175	176	176	176	176
	-	-				
-	-	-	-	-	-	-
-	-	-	-	-	-	-
418 mm	293 mm	268 mm	455 mm	455 mm	455 mm	455 mm
360°	360°	360°	360°	360°	360°	360°
-	-	-	Flexible hose Canna flessibile Flexibilní ramínko	Flexible hose Canna flessibile Flexibilní ramínko	Flexible hose Canna flessibile Flexibilní ramínko	Flexible hose Canna flessibile Flexibilní ramínko





130432	130335	24233401	161445	161446	192445	108498
178	179	179	180	180	180	181
-		-	-	-	-	-
-		-	-	-	-	-
		-				-
450 mm	256 mm	293 mm	303 mm	248 mm	368 mm	368 mm
360°	360°	360°	180°	360°	360°	360°
Extendable hose Canna estraibile Odnímateľné ramínko	Folding A scomparsa Sklápna	Folding A scomparsa Sklápna	Electronic Elettronica Elektronická	Electronic Elettronica Elektronická	Electronic Elettronica Elektronická	-



Reference Riferimento <i>Číslo výrobku</i>	163333	24234201	24221501	24231001	162453
Page Pagina <i>Strana</i>	181	181	181	181	535
Available finishes Finiture disponibili <i>Dostupné povrchové úpravy</i>					
Cold-opening Azionamento dell'acqua fredda <i>Otvor pro studenou vodu</i>	-	-	-	-	-
50% water flow Flusso al 50% <i>Průtok na 50%</i>	-	-	-	-	-
Quality certificates Certificati di qualità <i>Certifikáty jakosti</i>	-	-	-	-	-
Height Altezza <i>Výška</i>	427 mm	256 mm	82 mm	89 mm	304 mm
Rotation angle Angolo di rotazione <i>Úhel kohoutku</i>	360°	360°	360°	360°	360°
Function Funzionalità <i>Funkcionalita</i>	-	-	Wall Muro <i>Zed'</i>	Wall Muro <i>Zed'</i>	With chlorine filter Con filtro anticloro <i>Antichlorový filtr</i>



162456	03035501	03045501
535	535	535
		
-	-	-
-	-	-
-	-	-
304 mm	375 mm	375 mm
360°	360°	360°
For water treatment Per trattamento dell'acqua <i>Pro úpravu vody</i>	With chlorine filter Con filtro anticloro <i>Antichlorový filtr</i>	For water treatment Per trattamento dell'acqua <i>Pro úpravu vody</i>



Shower heads

Soffioni

Hlavové sprchy



Reference Riferimento Číslo výrobku	29996601	29996501	29997001	29997201	29997101	29996201	29995401	29995302	29995501	134951		
Page Pagina Strana	306	306	306	306	307	307	307	308	308	308		
Available finishes Finiture disponibili Dostupné povrchové úpravy												
Concealed Incastrati nel soffitto Zabudované do stropu	✓			✓			✓			✓		
Wall-mounted A muro Do stěny	-			-			-			-		
Ceiling-mounted A soffitto Do stropu	-			-			-			-		
Manufacturing material Materiale di fabbricazione Výrobní materiál	Stainless steel Acciaio inossidabile Nerezová ocel		Stainless steel Acciaio inossidabile Nerezová ocel			Stainless steel Acciaio inossidabile Nerezová ocel			Stainless steel Acciaio inossidabile Nerezová ocel			
Dimensions Dimensioni Rozměry	500x800		500x650			500x500			500x500			
Chromotherapy Cromoterapia Chromoterapie	-	✓	-	✓	-	✓	-	-	-	-		
Water outlets Uscite dell'acqua Odtok vody	3		2			3		1	2	1		
	✓		✓	✓	✓	✓	✓	✓	✓	✓		
	✓✓		✓	✓	✓	-	-	-	✓	-		
	-		-	-	✓	-	✓	-	-	-		
Water flow Flusso Průtok	20/16		18,5/16			18,5/16/8		14	20/8	20	20/16	24



29951607	29995301	134944	134714	29995601	29995701	29995801	134950	134940
309	308	309	313	309	309	310	310	310
✓	✓	✓	✓	✓	✓	✓	✓	✓
-	-	-	-	-	-	-	-	-
-	-	-	-	-	-	-	-	-
Stainless steel Acciaio inossidabile Nerezová ocel	Stainless steel Acciaio inossidabile Nerezová ocel	Stainless steel Acciaio inossidabile Nerezová ocel	-	Stainless steel Acciaio inossidabile Nerezová ocel			Stainless steel Acciaio inossidabile Nerezová ocel	
420x420	380x380	380x380	330x330	Ø600			Ø500	Ø380
-	-	-	-	-	✓	✓	-	-
1	1	1	1	2	1	2	1	1
✓	✓	✓	✓	✓	✓	✓	✓	✓
-	-	-	-	-	-	-	-	-
-	-	-	-	✓	-	✓	-	-
20	20	20	11	20/8	20	20/8	24	20



Reference Riferimento <i>Císlo výrobku</i>	134715	29990301	29990302	29990303	29990308	29990307	29990306	134903
Page Pagina <i>Strana</i>	312	311	311	311	312	312	312	313
Available finishes Finiture disponibili <i>Dostupné povrchové úpravy</i>								
Concealed Incassati nel soffitto <i>Zabudované do stropu</i>	✓	-	-	-	-	-	-	-
Wall-mounted A muro <i>Do stěny</i>	-	-	✓	-	-	✓	-	✓
Ceiling-mounted A soffitto <i>Do stropu</i>	-	-	-	-	-	-	-	-
Manufacturing material Materiale di fabbricazione <i>Výrobní materiál</i>	-	Stainless steel Acciaio inossidabile <i>Nerezová ocel</i>			Stainless steel Acciaio inossidabile <i>Nerezová ocel</i>			Stainless steel Acciaio inossidabile <i>Nerezová ocel</i>
Dimensions Dimensioni <i>Rozměry</i>	Ø330	280x550	210x550	160x550	280x550	210x550	160x550	280x550
Chromotherapy Cromoterapia <i>Chromoterapie</i>	-	-	-	-	-	-	-	-
Water outlets Uscite dell'acqua <i>Odtok vody</i>	1	2	1	1	2	1	1	2
	✓	✓	✓	✓	✓	✓	✓	✓
	-	✓	-	-	✓	-	-	✓
	-	-	-	-	-	-	-	-
Water flow Flusso <i>Průtok</i>	11	12/14	12,5	12,5	12/14	12,5	12,5	20/21



29990304	134315006	134315004	134315002	134315005	134315003	134315001	134315008	134315007	29963205	29963203
313	315	314	314	317	317	316	315	315	315	315
-	-	-	-	-	-	-	-	-	-	-
✓	✓	✓	✓	✓	✓	✓	✓	✓	✓	✓
-	✓	✓	✓	✓	✓	✓	✓	✓	✓	✓
Stainless steel Acciaio inossidabile <i>Nerezová ocel</i>	Stainless steel Acciaio inossidabile <i>Nerezová ocel</i>			Stainless steel Acciaio inossidabile <i>Nerezová ocel</i>			Stainless steel Acciaio inossidabile <i>Nerezová ocel</i>		Brass Ottone <i>Mosaz</i>	
152x200	300x300	250x250	200x200	Ø300	Ø250	Ø200	400x250	300x200	450x450	450x315
-	-	-	-	-	-	-	-	-	-	-
1	1	1	1	1	1	1	1	1	1	1
-	✓	✓	✓	✓	✓	✓	✓	✓	✓	✓
✓	-	-	-	-	-	-	-	-	-	-
-	-	-	-	-	-	-	-	-	-	-
16	-	-	-	-	-	-	-	-	16	14



Reference Riferimento <i>Císlo výrobku</i>	13413830	13413826	29963204	13413730	29963206	13413726	134315012	134315011
Page Pagina <i>Strana</i>	314	314	317	317	314	316	315	314
Available finishes Finiture disponibili <i>Dostupné povrchové úpravy</i>								
Concealed Incassati nel soffitto <i>Zabudované do stropu</i>	-	-	-	-	-	-	-	-
Wall-mounted A muro <i>Do stény</i>	✓		✓		✓	✓	✓	✓
Ceiling-mounted A soffitto <i>Do stropu</i>	✓		✓		✓	✓	✓	✓
Manufacturing material Materiale di fabbricazione <i>Výrobní materiál</i>	Brass Ottone <i>Mosaz</i>	-	Brass Ottone <i>Mosaz</i>		-	-	Stainless steel Acciaio inossidabile <i>Nerezová ocel</i>	
Dimensions Dimensioni <i>Rozměry</i>	300x300	250x250	Ø450	Ø300	220x220	Ø250	300x300	250x250
Chromotherapy Cromoterapia <i>Chromoterapie</i>	-	-	-	-	-	-	-	-
Water outlets Uscite dell'acqua <i>Odtok vody</i>	-	-	-	-	-	1	-	-
	✓		✓		✓	✓	✓	✓
	-		-		-	-	-	-
	-		-		-	-	-	-
Water flow Flusso <i>Průtok</i>	11	11	15	11	15	11	-	-



134315010	134315009	29933703
317	316	317



-	-
✓	✓
✓	✓



		Stainless steel Acciaio inossidabile Nerezová ocel
Ø300	Ø250	Ø310

-	-
-	-
✓	✓
-	-
-	-
-	11



Hand showers

Doccini

Ruční sprchy



Reference Riferimento Číslo výrobku	20263901	00663901	03463901	03411601	29974901	29974904	29974905	29974906
Page Pagina Strana	326	326	326	326	326	327	327	327
Available finishes Finiture disponibili Dostupné povrchové úpravy								
Manufacturing material Materiale di fabbricazione Výrobní materiál	Brass Ottone Mosaz	Brass Ottone Mosaz	-	Brass Ottone Mosaz	-	-	-	-
Dimensions Dimensioni Rozměry	-	-	-	-	Ø110	Ø130	Ø110	107x107
Number of functions Numero di funzioni Počet funkcí	1	1	1	1	5	3	3	3
Water flow Flusso Průtok	9,5	9,5	13	9,5	10/12,5 12/12,5/10	7/8/5	8,8/9,6/8,8	8,2/8,6/8,1



29963112	29963113	29963109	29963108	134612	913412380	29963105	134748	29974802	9134725
327	328	328	567	567	567	567	568	568	568
-	-	Brass Ottone Mosaz	-	-	Brass Ottone Mosaz	-	-	-	-
Ø110	96x110	Ø78	-	80x80	-	Ø110	Ø100	Ø100	Ø77
3	3	1	1	1	1	1	5	1	1
8,5/2/8,5	8,5/2/8,5	10	12	15	12	10	16/16,5 15,5/16/11	9,5	7,5

42 / **Basin mixer taps** | Lavabi | Koupelnová baterie



46 / **Bidets** | Bidet | Bidety



47 / **Bathtub mixer taps** | Monocomando esterno | Jednopákový mechanismus vany



48 / **Built-in sets** | Monocomando ad incasso | Vestavěné soupravy



50 / **Deck-mounted bathtubs** | Bordovasca | Vany s prodlouženým pultem



52 / **Thermostatically-controlled** | Termostatica | Termostatické

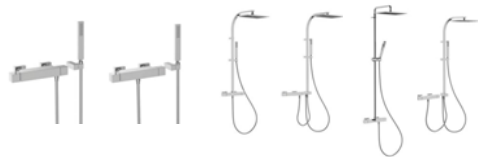

54 / **Block System**



55 / **Shower Technology**



SLIM EXCLUSIVE



www.qtrr.es/slim-exclusive



Chrome
Cromato



Gold 24K
Oro 24K
Zlato 24K



Matt Black
Nero Opaco
Černá mat



Matt gold 24K
Oro 24K Opaco
Zlato 24K mat



Matt White
Bianco Opaco
Bílá mat



Black-Chrome
Nero-Cromato
Černá-Chrom



Steel
Acciaio
Ocel



White-Chrome
Bianco-Cromato
Bílá-Chrom

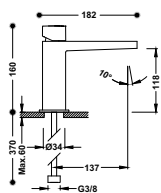

Single lever washbasin mixer
 Monocomando lavabo
 Jednopáková umyvadlová baterie



9130190

20210302 143,00
 20210302D 163,00

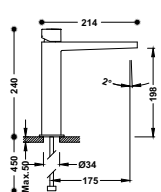

Single lever washbasin mixer
 Monocomando lavabo
 Jednopáková umyvadlová baterie



9130190

20210304 277,00

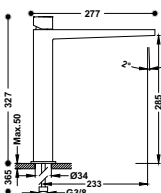

Single lever washbasin mixer
 Monocomando lavabo
 Jednopáková umyvadlová baterie



9130190

20210306 326,00





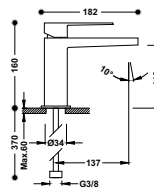

Single lever washbasin mixer
Monocomando lavabo
Jednopávková umyvadlová baterie

	20210301	143,00
	20210301D	163,00
	M 20210301NM	237,00
	M 20210301BM	237,00
	20210301AC	237,00
	24 20210301OR	286,00
	24 20210301OM	286,00
	20210301NE	237,00
	20210301BL	237,00



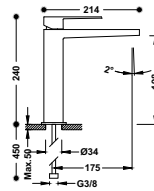

Single lever washbasin mixer
Monocomando lavabo
Jednopávková umyvadlová baterie

	20210303	277,00
	M 20210303NM	457,00
	M 20210303BM	457,00
	20210303AC	457,00
	24 20210303OR	554,00
	24 20210303OM	554,00
	20210303NE	457,00
	20210303BL	457,00



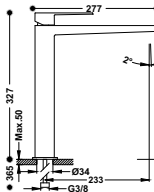

Single lever washbasin mixer
Monocomando lavabo
Jednopávková umyvadlová baterie

	20210305	326,00
	M 20210305NM	538,00
	M 20210305BM	538,00
	20210305AC	538,00
	24 20210305OR	651,00
	24 20210305OM	651,00
	20210305NE	538,00
	20210305BL	538,00



Single lever washbasin mixer
with open cascade spout. NOTE: Taps with a cascade spout come with 2 regulation valves and a filter (Nr.: 9134525)
Monocomando lavabo
con bocca a cascata aperta. NOTA: La rubinetteria con canna a cascata è accompagnata da 2 rubinetti di regolazione con filtro (Ref: 9134525)
Jednopávková umyvadlová baterie
ramínko s otevřeným vodopádem. POZNÁMKA: Baterie typu vodopádu je doplněna dvěma regulačními kohouty s filtrem (Kód: 9134525)

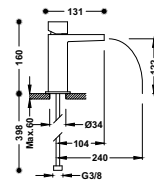

	20211002	251,00
	20211002NE	415,00
	20211002BL	415,00



Single lever washbasin mixer
with open cascade spout. NOTE: Taps with a cascade spout come with 2 regulation valves and a filter (Nr.: 9134525)
Monocomando lavabo
con bocca a cascata aperta. NOTA: La rubinetteria con canna a cascata è accompagnata da 2 rubinetti di regolazione con filtro (Ref: 9134525)
Jednopávková umyvadlová baterie
ramínko s otevřeným vodopádem. POZNÁMKA: Baterie typu vodopádu je doplněna dvěma regulačními kohouty s filtrem (Kód: 9134525)

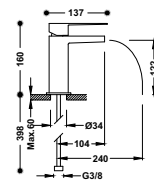

	20211001	251,00
	20211001NE	415,00
	20211001BL	415,00

Single lever wall washbasin mixer
Indivisible concealed body with buffers. Anti-moisture seal. Spout 180 mm.

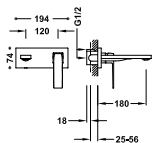

Monomando a muro
 Corpo a incasso indivisibile con smorzatori. Guarnizione antiumidità. Canna 180 mm.

20230011 **227,00**

Jednopávková nástěnná baterie

Podomítkové těleso v nedělitelném provedení s tlumiči. Těsnění proti vlhkosti. Ramínko 180 mm.

M 20230011NM **374,00**

M 20230011BM **374,00**

M 20230011AC **374,00**

Z 20230011OR **453,00**

Z 20230011OM **453,00**



29902801

Single lever wall washbasin mixer
Indivisible concealed body with buffers. Anti-moisture seal. Spout 240 mm.

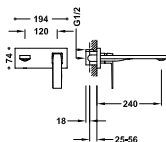

Monomando a muro
 Corpo a incasso indivisibile con smorzatori. Guarnizione antiumidità. Canna 240 mm.

20230012 **237,00**

Jednopávková nástěnná baterie

Podomítkové těleso v nedělitelném provedení s tlumiči. Těsnění proti vlhkosti. Ramínko 240 mm.

M 20230012NM **390,00**

M 20230012BM **390,00**

M 20230012AC **390,00**

Z 20230012OR **474,00**

Z 20230012OM **474,00**



29902801

Single lever wall washbasin mixer
Indivisible concealed body with buffers. Anti-moisture seal. Spout 180 mm.

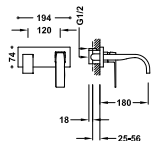

Monomando a muro
 Corpo a incasso indivisibile con smorzatori. Guarnizione antiumidità. Canna 180 mm.

20230013 **247,00**

Jednopávková nástěnná baterie

Podomítkové těleso v nedělitelném provedení s tlumiči. Těsnění proti vlhkosti. Ramínko 180 mm.

M 20230013NM **425,00**

M 20230013BM **425,00**

M 20230013AC **425,00**

Z 20230013OR **515,00**

Z 20230013OM **515,00**



29902801

Single lever wall washbasin mixer
Indivisible concealed body with buffers. Anti-moisture seal. Spout 240 mm.

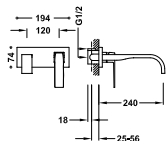

Monomando a muro
 Corpo a incasso indivisibile con smorzatori. Guarnizione antiumidità. Canna 240 mm.

20230014 **258,00**

Jednopávková nástěnná baterie

Podomítkové těleso v nedělitelném provedení s tlumiči. Těsnění proti vlhkosti. Ramínko 240 mm.

M 20230014NM **441,00**

M 20230014BM **441,00**

M 20230014AC **441,00**

Z 20230014OR **536,00**

Z 20230014OM **536,00**



29902801

Single lever wall washbasin mixer
Indivisible concealed body with buffers. Anti-moisture seal. Spout 180 mm.

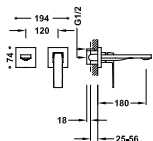

Monomando a muro
 Corpo a incasso indivisibile con smorzatori. Guarnizione antiumidità. Canna 180 mm.

20230001 **196,00**

Jednopávková nástěnná baterie

Podomítkové těleso v nedělitelném provedení s tlumiči. Těsnění proti vlhkosti. Ramínko 180 mm.

M 20230001NM **323,00**

M 20230001BM **323,00**

M 20230001AC **323,00**

Z 20230001OR **391,00**

Z 20230001OM **391,00**



29902801

Single lever wall washbasin mixer
Indivisible concealed body with buffers. Anti-moisture seal. Spout 240 mm.

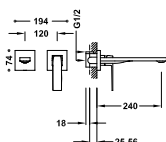

Monomando a muro
 Corpo a incasso indivisibile con smorzatori. Guarnizione antiumidità. Canna 240 mm.

20230002 **206,00**

Jednopávková nástěnná baterie

Podomítkové těleso v nedělitelném provedení s tlumiči. Těsnění proti vlhkosti. Ramínko 240 mm.

M 20230002NM **339,00**

M 20230002BM **339,00**

M 20230002AC **339,00**

Z 20230002OR **412,00**

Z 20230002OM **412,00**



29902801

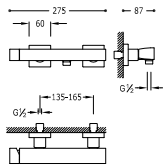

Single lever shower mixer

Anti-limescale hand shower with directable support. Shower hose SATIN.

Monocomando doccia

Doccetta anticalcare con supporto orientabile. Flessibile satin.

Jednopáková sprchová baterie

Ruční sprcha s nastavitelným držákem, proti usaz. vod. kamene. Flexi hadice SATIN.



	20216701	279,00
	M 20216701NM	461,00
	M 20216701BM	461,00
	M 20216701AC	461,00
	24 20216701OR	558,00
	24 20216701OM	558,00
	20216701NE	461,00
	20216701BL	461,00

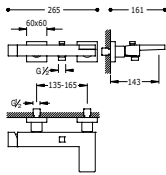

Single lever bath and shower mixer

Anti-limescale hand shower with directable support. Shower hose SATIN.

Monocomando vasca

Doccetta anticalcare con supporto orientabile. Flessibile satin.

Jednopáková baterie pro vanu-sprchu

Ruční sprcha s nastavitelným držákem, proti usaz. vod. kamene. Flexi hadice SATIN.



	20217001	308,00
	M 20217001NM	509,00
	M 20217001BM	509,00
	M 20217001AC	509,00
	24 20217001OR	616,00
	24 20217001OM	616,00
	20217001NE	509,00
	20217001BL	509,00

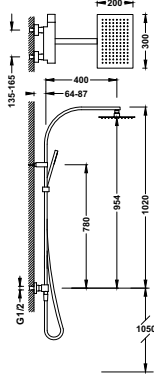

Concealed shower set

- Fixed shower head 300x200 mm. with ball joint. Stainless material.
- Anti-limescale hand shower.
- Shower hose SATIN.

Kit doccia

- Doccia fissa 300x200 mm. con snodo. Materiale acciaio inossidabile.
- Doccetta anticalcare.
- Flessibile satin.

Sprchový set

- Hlavová sprcha 300x200 mm. s kloubem.
- Ruční sprcha, proti usaz. vod. kamene.
- Flexi hadice SATIN.



	20219101	676,00
	M 20219101NM	1.116,00
	M 20219101BM	1.116,00
	M 20219101AC	1.116,00



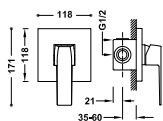

Built-in mixer taps RAPID-BOX (1 way)

Concealed body with buffers. ABS embedding box. Anti-moisture seal.

Monocomando incasso RAPID-BOX (1 via)

Corpo a incasso con smorzatori. Scatola da incasso in ABS. Guarnizione antiumidità.

Vestavěná jednopávková baterie RAPID-BOX (jednocestný)

Podomítkové těleso s tlumiči. Krabice ABS k zabudování do zdi. Těsnění proti vlhkosti.



29903507

	20227701	126,00
	20227701NM	201,00
	20227701BM	201,00
	20227701AC	201,00
	20227701OR	251,00
	20227701OM	251,00

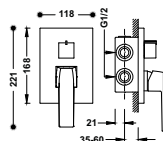

Built-in mixer taps RAPID-BOX (2 way)

Concealed body with buffers. ABS embedding box. Anti-moisture seal.

Monocomando incasso RAPID-BOX (2 vie)

Corpo a incasso con smorzatori. Scatola da incasso in ABS. Guarnizione antiumidità.

Vestavěná jednopávková baterie RAPID-BOX (dvoucestný)

Podomítkové těleso s tlumiči. Krabice ABS k zabudování do zdi. Těsnění proti vlhkosti.



29903507

	20228001	214,00
	20228001NM	343,00
	20228001BM	343,00
	20228001AC	343,00
	20228001OR	429,00
	20228001OM	429,00

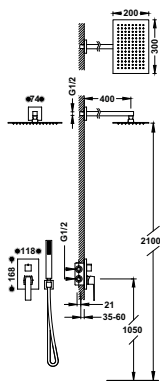

Concealed shower set RAPID-BOX

with water shut off and flow control.

- Built-in body included
- Stainless steel fixed shower head 300x200 mm. With ball joint.
- Elbow wall.
- Anti-limescale hand shower.
- Shower hose SATIN.

Kit doccia ad incasso RAPID-BOX

Con chiusura e regolazione di portata.

- Corpo incassato incluso
- Doccia fissa acciaio inossidabile 300x200 mm. con snodo.
- Supporto per doccia.
- Doccetta anticalcare.
- Flessibile satin.

Podomítkový jednopávkový sprchový set RAPID-BOX

s uzávěrem a regulací průtoku.

- Včetně podomítkového tělesa
- Pevná sprcha 300x200 mm. s kloboukem. Materiál nerez. oceli.
- Držák s nástěnným přívodem vody
- Ruční sprcha, proti usaz. vod. kamene.
- Flexi hadice SATIN.



29903507

	20228004	572,00
	20228004NM	943,00
	20228004BM	943,00
	20228004AC	943,00
	20228004OR	1.143,00
	20228004OM	1.143,00

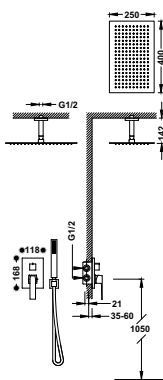

Concealed shower set RAPID-BOX

with water shut off and flow control.

- Built-in body included
- Stainless steel fixed shower head 400x250 mm. with ball joint.
- Elbow wall.
- Anti-limescale hand shower.
- Shower hose SATIN.

Kit doccia ad incasso RAPID-BOX

Con chiusura e regolazione di portata.

- Corpo incassato incluso
- Doccia fissa acciaio inossidabile 400x250 mm. con snodo.
- Supporto per doccia.
- Doccetta anticalcare.
- Flessibile satin.

Podomítkový jednopávkový sprchový set RAPID-BOX

s uzávěrem a regulací průtoku.

- Včetně podomítkového tělesa
- Pevná sprcha 400x250 mm. s kloboukem. Materiál nerez. oceli.
- Držák s nástěnným přívodem vody
- Ruční sprcha, proti usaz. vod. kamene.
- Flexi hadice SATIN.



29903507

	20228003	546,00
	20228003NM	901,00
	20228003BM	901,00
	20228003AC	901,00
	20228003OR	1.092,00
	20228003OM	1.092,00

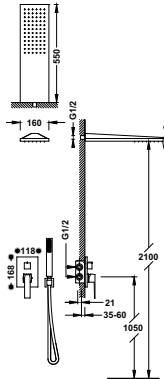

Concealed shower set RAPID-BOX
with water shut off and flow control.

- Built-in body included
- Stainless steel wall shower 160x550 mm.
- Elbow wall.
- Anti-limescale hand shower.
- Shower hose SATIN.

Kit doccia ad incasso RAPID-BOX
Con chiusura e regolazione di portata.

- Corpo incassato incluso
- Doccia acciaio inossidabile da parete 160x550 mm.
- Supporto per doccia.
- Doccetta anticalcare.
- Flessibile satin.

Podomítkový jednopákový sprchový set RAPID-BOX
s uzávěrem a regulací průtoku.

- Včetně podomítkového tělesa
- Nástěnné sprchové křepítko z nerez. oceli 160x550 mm.
- Držák s nástěnným přívodem vody.
- Ruční sprcha, proti usaz. vod. kamene
- Flexi hadice SATIN.

■	20228005	646,00
■	20228005NM	1.066,00
■	20228005BM	1.066,00
■	20228005AC	1.066,00
■	20228005OR	1.292,00
■	20228005OM	1.292,00

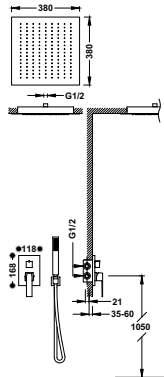

Concealed shower set RAPID-BOX
with water shut off and flow control.

- Built-in body included
- Steel shower head 380x380 mm.
- Elbow wall.
- Anti-limescale hand shower.
- Shower hose SATIN.

Kit doccia ad incasso RAPID-BOX
Con chiusura e regolazione di portata.

- Corpo incassato incluso
- Soffione doccia acciaio inossidabile 380x380 mm.
- Supporto per doccia.
- Doccetta anticalcare.
- Flessibile satin.

Podomítkový jednopákový sprchový set RAPID-BOX
s uzávěrem a regulací průtoku.

- Včetně podomítkového tělesa
- Sprchové křepítko z nerez. oceli 380x380 mm.
- Držák s nástěnným přívodem vody.
- Ruční sprcha, proti usaz. vod. kamene.
- Flexi hadice SATIN.

■	20228006	887,00
■	20228006NM	1.463,00
■	20228006BM	1.463,00
■	20228006AC	1.463,00
■	20228006OR	1.774,00
■	20228006OM	1.774,00

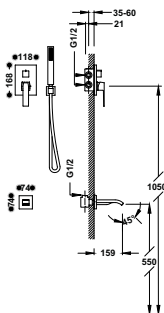

Concealed shower set RAPID-BOX
with water shut off and flow control.

- Built-in body included.
- Bath spout.
- Elbow wall.
- Anti-limescale hand shower.
- Shower hose SATIN.

Kit doccia ad incasso RAPID-BOX
Con chiusura e regolazione di portata.

- Corpo incassato incluso.
- Canna per vasca da bagno.
- Supporto per doccia.
- Doccia anticalcare.
- Flessibile satin.

Podomítkový jednopákový sprchový set RAPID-BOX
s uzávěrem a regulací průtoku.

- Včetně podomítkového tělesa.
- Kahautek pro vanu.
- Držák s nástěnným přívodem vody.
- Ruční sprcha, proti usaz. vod. kamene.
- Flexi hadice SATIN.

■	20228007	294,00
■	20228007NM	484,00
■	20228007BM	484,00
■	20228007AC	484,00
■	20228007OR	587,00
■	20228007OM	587,00



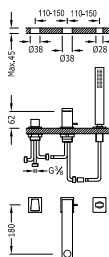

Bath-shower single lever tap for bracket shelf with shower Anti-limescale.
 - Flowrate: 3 bar – 13 l/m.
 - Compatible with tank kit ref: 20224501.
 - Spout 180 mm.

Monocomando bordo vasca con doccetta anticalcare.
 - Portata: 3 bar – 13 l/m.
 - Compatibile con il kit serbatoio cod: 20224501.
 - Canna 180 mm.

Jednopávková stojánková baterie
 Sprcha, proti usaz. vod. Kamene.
 - Průtok: 3 bar – 13 l/m
 - Kompatibilní se sadou nádrže ref. č.: 20224501.
 - Ramínko 180 mm.



20216104

420,00

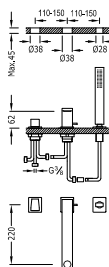

Bath-shower single lever tap for bracket shelf with shower Anti-limescale.
 - Flowrate: 3 bar – 13 l/m.
 - Compatible with tank kit ref: 20224501.
 - Spout 220 mm.

Monocomando bordo vasca con doccetta anticalcare.
 - Portata: 3 bar – 13 l/m.
 - Compatibile con il kit serbatoio cod: 20224501.
 - Canna 220 mm.

Jednopávková stojánková baterie
 Sprcha, proti usaz. vod. Kamene.
 - Průtok: 3 bar – 13 l/m
 - Kompatibilní se sadou nádrže ref. č.: 20224501.
 - Ramínko 220 mm.



20216102

432,00

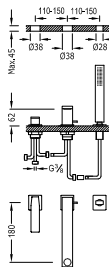

Bath-shower single lever tap for bracket shelf with shower Anti-limescale.
 - Flowrate: 3 bar – 13 l/m.
 - Compatible with tank kit ref: 20224501.
 - Spout 180 mm.

Monocomando bordo vasca con doccetta anticalcare.
 - Portata: 3 bar – 13 l/m.
 - Compatibile con il kit serbatoio cod: 20224501.
 - Canna 180 mm.

Jednopávková stojánková baterie
 Sprcha, proti usaz. vod. Kamene.
 - Průtok: 3 bar – 13 l/m
 - Kompatibilní se sadou nádrže ref. č.: 20224501.
 - Ramínko 180 mm.



20216103

420,00

- 20216103NM **694,00**
- 20216103BM **694,00**
- 20216103AC **694,00**
- 20216103OR **841,00**
- 20216103OM **841,00**

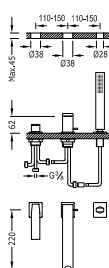

Bath-shower single lever tap for bracket shelf with shower Anti-limescale.
 - Flowrate: 3 bar – 13 l/m.
 - Compatible with tank kit ref: 20224501.
 - Spout 220 mm.

Monocomando bordo vasca con doccetta anticalcare.
 - Portata: 3 bar – 13 l/m.
 - Compatibile con il kit serbatoio cod: 20224501.
 - Canna 220 mm.

Jednopávková stojánková baterie
 Sprcha, proti usaz. vod. Kamene.
 - Průtok: 3 bar – 13 l/m
 - Kompatibilní se sadou nádrže ref. č.: 20224501.
 - Ramínko 220 mm.



20216101

432,00

- 20216101NM **713,00**
- 20216101BM **713,00**
- 20216101AC **713,00**
- 20216101OR **863,00**
- 20216101OM **863,00**



24

Bath-shower single lever tap for bracket shelf with cascade cast spout and Anti-limescale hand shower.

- Flowrate: 3 bar – 13 l/m.
- Compatible with tank kit ref: 20224501.

Monocomando bordo vasca

- Con bocca a cascata, doccetta anticalcare.
- Portata: 3 bar – 13 l/m.
- Compatibile con il kit serbatoio cod: 20224501.

Jednopávková vanová stojánková baterie s ramínkem kaskádou. Sprcha, proti usaz. vod. Kamene.

- Průtok: 3 bar – 13 l/m
- Kompatibilní se sadou nádrže ref. č.: 20224501.

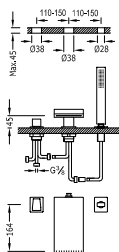

20266102

802,00

Bath-shower single lever tap for bracket shelf with cascade cast spout and Anti-limescale hand shower.

- Flowrate: 3 bar – 13 l/m.
- Compatible with tank kit ref: 20224501.

Monocomando bordo vasca

- Con bocca a cascata, doccetta anticalcare.
- Portata: 3 bar – 13 l/m.
- Compatibile con il kit serbatoio cod: 20224501.

Jednopávková vanová stojánková baterie s ramínkem kaskádou. Sprcha, proti usaz. vod. Kamene.

- Průtok: 3 bar – 13 l/m
- Kompatibilní se sadou nádrže ref. č.: 20224501.

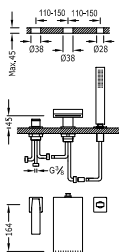

20266101

802,00

TERMOSTATICALLY-CONTROLLED | TERMOSTATICHÉ | TERMOSTATICKÉ

Wall thermostatic shower mixer

Anti-limescale hand shower with directable support. Shower hose SATIN.

910616110	299312010R	
29931201NM	29931201OM	
29931201BM	910616116	
910616153	910616114	

Doccia termostatica

Doccetta anticalcare con supporto orientabile. Flessibile satin.

Termostatická sprchová baterie

Ruční sprcha s nastavitelným držákem, proti usaz. vod. kamene. Flexi hadice SATIN.

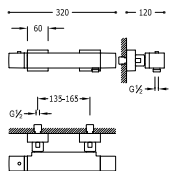

(1/2)		20216409	356,00
(1)		20216409NM	588,00
(1)		20216409BM	588,00
(1)		20216409AC	588,00
(1)		20216409OR	713,00
(1)		20216409OM	713,00
(1)		20216409NE	588,00
(1)		20216409BL	588,00



Wall thermostatic bath and shower mixer

with cascade. Anti-limescale hand shower with directable support. Shower hose SATIN. Diverter integrated in the flow control.

910616110	29931201OR	
29931201NM	29931201OM	
29931201BM	910616116	
910616153	910616114	

Vasca-Doccia termostatica

Con bocca a cascata. Doccetta anticalcare con supporto orientabile. Flessibile satin. Invertitore integrato nel regolatore di portata.

Termostatická baterie pro vanu a sprchu

s kaskádou. Ruční sprcha s nastavitelným držákem, proti usaz. vod. kamene. Flexi hadice SATIN. Přepínač zabudovaný v regulaci průtoku.

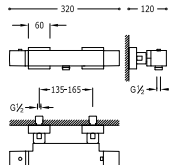

(1)		20217409	410,00
(1)		20217409NM	677,00
(1)		20217409BM	677,00
(1)		20217409AC	677,00
(1)		20217409OR	820,00
(1)		20217409OM	820,00
(1)		20217409NE	677,00
(1)		20217409BL	677,00



Wall thermostatic shower mixer

Fixed shower head 300x200 mm. with ball joint. Stainless material.

- Anti-limescale hand shower.
- Shower hose SATIN.
- Diverter integrated in the flow control.

910616110	910616153	
29931201NM	910616116	
29931201BM	910616114	

Set doccia termostatica

- Doccia fissa 300x200 mm. con snodo. Materiale acciaio inossidabile.
- Doccetta anticalcare.
- Flessibile satin.
- Invertitore integrato nel regolatore di portata.

Souprava termostatické sprchové baterie

- Pevná sprcha 300x200 mm. s kloubem. Materiál nerezová ocel.
- Ruční sprcha, proti usaz. vod. kamene.
- Flexi hadice SATIN.
- Přepínač zabudovaný v regulaci průtoku.

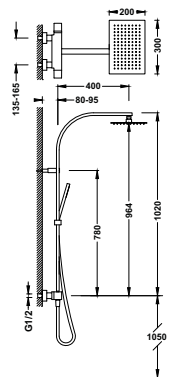

		20219501	858,00
		20219501NM	1.416,00
		20219501BM	1.416,00
		20219501AC	1.416,00
		20219501NE	1.416,00
		20219501BL	1.416,00



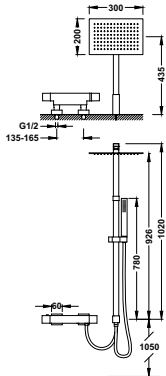

Wall thermostatic shower mixer

- Fixed shower head 300x200 mm. with ball joint. Stainless material.
- Anti-limescale hand shower.
- Shower hose SATIN.

Set doccia termostatica

- Doccia fissa 300x200 mm. con snodo. Materiale acciaio inossidabile.
- Doccetta anticalcare.
- Flessibile satin.

Souprava termostatické sprchové baterie

- Pevná sprcha 300x200 mm. s kloubem. Materiál nerezová ocel.
- Ruční sprcha, proti usaz. vod. kamene.
- Flexi hadice SATIN.



20238501

662,00

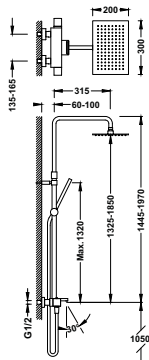

Wall thermostatic bath mixer (3 ways)

- Fixed shower head 300x200 mm. with ball joint. Stainless material.
- Anti-limescale hand shower.
- Shower hose SATIN.
- Telescopic bar.
- Diverter integrated in the flow control.

Idrodoccia termostatica (3 vie)

- Doccia fissa 300x200 mm. con snodo. Materiale acciaio inossidabile.
- Doccetta anticalcare.
- Flessibile satin.
- Asta telescopica.
- Invertitore integrato nel regolatore di portata.

Souprava termostatické baterie pro vanu-sprchu (3-cestná)

- Pevná sprcha 300x200 mm. s kloubem. Materiál nerezová ocel.
- Ruční sprcha, proti usaz. vod. kamene.
- Flexi hadice SATIN.
- Teleskopická tyč.
- Přepínač zabudovaný v regulaci průtoku.



20231201

886,00

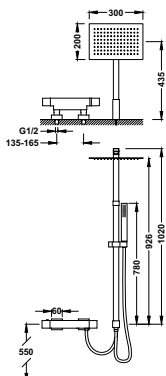

Wall thermostatic bath mixer

- Fixed shower head 300x200 mm. with ball joint. Stainless material.
- Anti-limescale hand shower.
- Shower hose SATIN.

Idrodoccia termostatica

- Doccia fissa 300x200 mm. con snodo. Materiale acciaio inossidabile.
- Doccetta anticalcare.
- Flessibile satin.

Souprava termostatické baterie pro vanu-sprchu

- Pevná sprcha 300x200 mm. s kloubem. Materiál nerezová ocel.
- Ruční sprcha, proti usaz. vod. kamene.
- Flexi hadice SATIN.



20238502

715,00

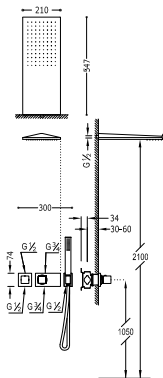

Concealed thermostatic shower kit BLOCK SYSTEM
with water shut off and flow control (2 ways).

- Built-in thermostatic body included.
- Stainless steel wall shower 210x550 mm.
- Anti-limescale hand shower.
- Shower hose SATIN.

Kit doccia termostatica ad incasso BLOCK SYSTEM

Con chiusura e regolazione di portata (2 vie).

- Corpo incassato termostatico incluso.
- Doccia acciaio inossidabile da parete 210x550 mm.
- Doccetta anticalcare.
- Flessibile satin.

Termostatický podomítkový sprchový set BLOCK SYSTEM

s uzávěrem a regulací průtoku (2-cestná).

- Včetně podomítkového termostatického tělesa.
- Nástěnné sprchové křepitko z nerez. oceli 210x550 mm.
- Ruční sprcha, proti usaz. vod. kamene.
- Flexi hadice SATIN.

2992504S	29925045OR	
29925045BM	29925045OM	
29925045BM	29925045NE	
29925045AC	29925045BL	

	20725202	1.015,00
	20725202NM	1.675,00
	20725202BM	1.675,00
	20725202AC	1.675,00
	20725202OR	2.029,00
	20725202OM	2.029,00
	20725202NE	1.675,00
	20725202BL	1.675,00



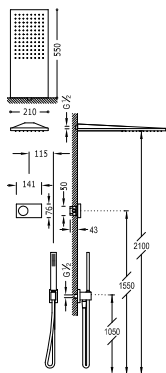

Built-in electronic thermostatic shower kit SHOWER TECHNOLOGY BLUE EDITION

- Electronic control included with Schlüter anti-moisture seals.
- Electronic thermostatic control box included (2 ways).
- Stainless steel wall shower 210x550 mm.
- Elbow wall.
- Antilime hand shower.
- Shower hose SATIN.

Kit elettronico per doccia termostatico da incasso SHOWER TECHNOLOGY BLUE EDITION

- Controllo elettronico incluso con guarnizioni anti-umidità Schlüter.
- Centralina termostatica elettronica inclusa (2 vie).
- Doccia acciaio inossidabile da parete 210x550 mm.
- Supporto per doccia.
- Doccetta anticalcare.
- Flessibile satin.

Termostatický podomítkový elektronický sprchový set SHOWER TECHNOLOGY BLUE EDITION

- Součástí kontrolní skříňka s těsněním od firmy Schlüter.
- Zabudovaná termostatická elektronická kontrolní jednotka (2-cestná).
- Nástěnné sprchové hroptítko z nerez. oceli 210x550 mm.
- Držák s nástěnným přívodem vody.
- Ruční sprcha, proti usaz. vod. kamene.
- Flexi hadice SATIN.



09286551 1.045,00

M 09286551BM 1.491,00

09286551AC 1.491,00



09288551 1.045,00

M 09288551NM 1.491,00

09288551AC 1.491,00



58 / **Basin mixer taps** | Lavabi | Koupelnová baterie64 / **Bidets** | Bidet | Bidety65 / **Bathtub mixer taps** | Monocomando esterno | Jednopákový mechanismus vany65 / **Built-in sets** | Monocomando ad incasso | Vestavěné soupravy67 / **Deck-mounted bathtubs** | Bordovasca | Vany s prodlouženým pultem68 / **Thermostatically-controlled** | Termostatica | Termostatické69 / **Block System**

CUADRO EXCLUSIVE



www.qtr.es/cuadro-exclusive



Chrome
Cromato
Chrom



24
Gold 24K
Oro 24K
Zlato 24K



Matt Black
Nero Opaco
Cerná mat



24M
Matt gold 24K
Oro 24K Opaco
Zlato 24K mat



Matt White
Bianco Opaco
Bílá mat



Black-Chrome
Nero-Cromato
Cerná-Chrom



Steel
Acciaio
Ocel



White-Chrome
Bianco-Cromato
Bílá-Chrom



Single lever washbasin mixer

with cascade cast spout. NOTE: Taps with a cascade spout come with 2 regulation valves and a filter (Nr.: 9134525)

Monocomando lavabo

con bocca a cascata. NOTA: La rubinetteria con canna a cascata è accompagnata da 2 rubinetti di regolazione con filtro (Ref: 9134525)

Jednopávková umyvadlová baterie ramínko s kaskádou. POZNÁMKA: Baterie typu vodopádu je doplněna dvěma regulačními kohouty s filtrem (Kód: 9134525)

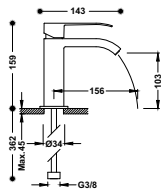

29919001

M	00610101NM	238,00
M	00610101BM	238,00
	00610101AC	238,00
24	00610101OR	288,00
24	00610101OM	288,00
	00610101NE	238,00
	00610101BL	238,00

Single lever washbasin mixer

with cascade cast spout. NOTE: Taps with a cascade spout come with 2 regulation valves and a filter (Nr.: 9134525)

Monocomando lavabo

con bocca a cascata. NOTA: La rubinetteria con canna a cascata è accompagnata da 2 rubinetti di regolazione con filtro (Ref: 9134525)

Jednopávková umyvadlová baterie ramínko s kaskádou. POZNÁMKA: Baterie typu vodopádu je doplněna dvěma regulačními kohouty s filtrem (Kód: 9134525)

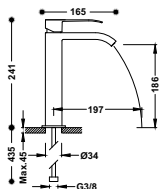

29919001

M	00661001NM	459,00
M	00661001BM	459,00
	00661001AC	459,00
24	00661001OR	556,00
24	00661001OM	556,00
	00661001NE	459,00
	00661001BL	459,00



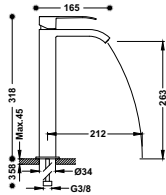

Single lever washbasin mixer
with cascade cast spout. NOTE: Taps with a cascade spout come with 2 regulation valves and a filter (Nr.: 9134525)

Monocomando lavabo
con bocca a cascata. NOTA: La rubinetteria con canna a cascata è accompagnata da 2 rubinetti di regolazione con filtro (Ref: 9134525)

Jednopáková umyvadlová baterie
ramínko s kaskádou. POZNÁMKA: Baterie typu vodopádu je doplněna dvěma regulačními kohouty s filtrem (Kód: 9134525)

	00681001NM	538,00
	00681001BM	538,00
	00681001AC	538,00
	00681001OR	651,00
	00681001OM	651,00
	00681001NE	538,00
	00681001BL	538,00

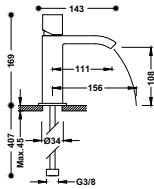

Single lever washbasin mixer
with open cascade spout. NOTE: Taps with a cascade spout come with 2 regulation valves and a filter (Nr.: 9134525)

Monocomando lavabo
con bocca a cascata aperta. NOTA: La rubinetteria con canna a cascata è accompagnata da 2 rubinetti di regolazione con filtro (Ref: 9134525)

Jednopáková umyvadlová baterie
ramínko s otevřeným vodopádem. POZNÁMKA: Baterie typu vodopádu je doplněna dvěma regulačními kohouty s filtrem (Kód: 9134525)

	00611002NE	394,00
	00611002BL	394,00

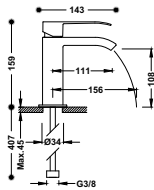

Single lever washbasin mixer
with open cascade spout. NOTE: Taps with a cascade spout come with 2 regulation valves and a filter (Nr.: 9134525)

Monocomando lavabo
con bocca a cascata aperta. NOTA: La rubinetteria con canna a cascata è accompagnata da 2 rubinetti di regolazione con filtro (Ref: 9134525)

Jednopáková umyvadlová baterie
ramínko s otevřeným vodopádem. POZNÁMKA: Baterie typu vodopádu je doplněna dvěma regulačními kohouty s filtrem (Kód: 9134525)

	00611001NE	394,00
	00611001BL	394,00

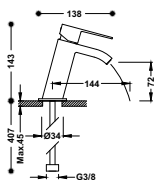

Single lever washbasin mixer
with cascade cast spout. NOTE: Taps with a cascade spout come with 2 regulation valves and a filter (Nr.: 9134525)

Monocomando lavabo
con bocca a cascata. NOTA: La rubinetteria con canna a cascata è accompagnata da 2 rubinetti di regolazione con filtro (Ref: 9134525)

Jednopáková umyvadlová baterie
ramínko s kaskádou. POZNÁMKA: Baterie typu vodopádu je doplněna dvěma regulačními kohouty s filtrem (Kód: 9134525)

	00620101NM	238,00
	00620101BM	238,00
	00620101AC	238,00
	00620101OR	288,00
	00620101OM	288,00
	00620101NE	238,00
	00620101BL	238,00





24 M

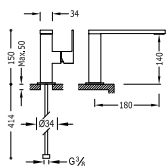

Single lever washbasin mixer spout 34x10 mm.

Monocomando lavabo canna 34x10 mm.

Jednopáková umyvadlová baterie ramínko 34x10 mm



M	00620501NM	376,00
M	00620501BM	376,00
M	00620501AC	376,00
24	00620501OR	455,00
24	00620501OM	455,00

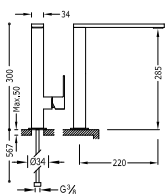

Single lever washbasin mixer spout 34x10 mm.

Monocomando lavabo canna 34x10 mm.

Jednopáková umyvadlová baterie ramínko 34x10 mm



M	00648501NM	535,00
M	00648501BM	535,00
M	00648501AC	535,00
24	00648501OR	647,00
24	00648501OM	647,00

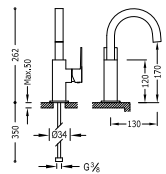

Single lever washbasin mixer spout 22x22 mm.

Monocomando lavabo canna 22x22 mm.

Jednopáková umyvadlová baterie ramínko 22x22 mm



M	00660502NM	365,00
M	00660502BM	365,00
M	00660502AC	365,00
24	00660502OR	441,00
24	00660502OM	441,00

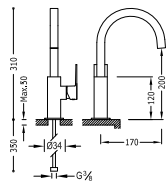

Single lever washbasin mixer spout 22x22 mm.

Monocomando lavabo canna 22x22 mm.

Jednopáková umyvadlová baterie ramínko 22x22 mm



M	00660602NM	381,00
M	00660602BM	381,00
M	00660602AC	381,00
24	00660602OR	461,00
24	00660602OM	461,00



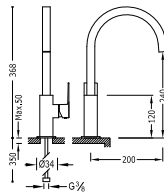

Single lever washbasin mixer spout 22x22 mm.

Monocomando lavabo canna 22x22 mm.

Jednopáková umyvadlová baterie ramínko 22x22 mm



M	00660702NM	405,00
M	00660702BM	405,00
M	00660702AC	405,00
Z4	00660702OR	490,00
Z4	00660702OM	490,00

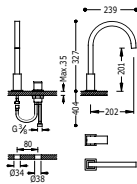

Deck-mounted washbasin mixer tap Free installation. Spout 22x22 mm.

Monocomando lavabo a mensola Ad installazione libera. Canna 22x22 mm.

Páková baterie k umyvadlu Možnost samostatné instalace. Ramínko 22x22 mm



M	00610503NM	332,00
M	00610503BM	332,00
M	00610503AC	332,00
Z4	00610503OR	402,00
Z4	00610503OM	402,00

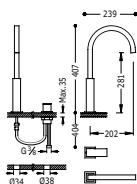

Deck-mounted washbasin mixer tap Free installation. Spout 22x22 mm.

Monocomando lavabo a mensola Ad installazione libera. Canna 22x22 mm.

Páková baterie k umyvadlu Možnost samostatné instalace. Ramínko 22x22 mm



M	00610504NM	340,00
M	00610504BM	340,00
M	00610504AC	340,00
Z4	00610504OR	412,00
Z4	00610504OM	412,00

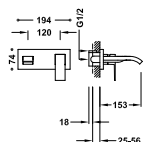

Single lever wall washbasin mixer
Indivisible concealed body with buffers. Anti-moisture seal. Spout 153 mm.

Monomando a muro
 Corpo a incasso indivisibile con smorzatori. Guarnizione antiumidità. Canna 153 mm.

Jednopávková nástěnná baterie
 Podomítkové těleso v nedělitelném provedení s tlumiči. Těsnění proti vlhkosti. Ramínko 153 mm.



M	00630013NM	491,00
M	00630013BM	491,00
M	00630013AC	491,00
24	00630013OR	595,00
24	00630013OM	595,00

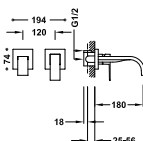

Single lever wall washbasin mixer
Indivisible concealed body with buffers. Anti-moisture seal. Spout 180 mm.

Monomando a muro
 Corpo a incasso indivisibile con smorzatori. Guarnizione antiumidità. Canna 180 mm.

Jednopávková nástěnná baterie
 Podomítkové těleso v nedělitelném provedení s tlumiči. Těsnění proti vlhkosti. Ramínko 180 mm.



M	00630001NM	348,00
M	00630001BM	348,00
M	00630001AC	348,00
24	00630001OR	422,00
24	00630001OM	422,00

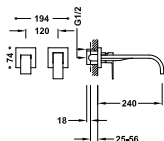

Single lever wall washbasin mixer
Indivisible concealed body with buffers. Anti-moisture seal. Spout 240 mm.

Monomando a muro
 Corpo a incasso indivisibile con smorzatori. Guarnizione antiumidità. Canna 240 mm.

Jednopávková nástěnná baterie
 Podomítkové těleso v nedělitelném provedení s tlumiči. Těsnění proti vlhkosti. Ramínko 240 mm.



M	00630002NM	365,00
M	00630002BM	365,00
M	00630002AC	365,00
24	00630002OR	443,00
24	00630002OM	443,00

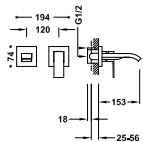

Single lever wall washbasin mixer
Indivisible concealed body with buffers. Anti-moisture seal. Spout 153 mm.

Monomando a muro
 Corpo a incasso indivisibile con smorzatori. Guarnizione antiumidità. Canna 153 mm.

Jednopávková nástěnná baterie
 Podomítkové těleso v nedělitelném provedení s tlumiči. Těsnění proti vlhkosti. Ramínko 153 mm.



M	00630003NM	440,00
M	00630003BM	440,00
M	00630003AC	440,00
24	00630003OR	534,00
24	00630003OM	534,00

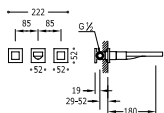

Single hole wall mixer
Built-in body is included and indivisible. Spout 180 mm.

Monoblocco a muro
 Corpo incassato incluso e indivisibile. Canna 180 mm.

Nástěnná umyvadlová baterie
 Včetně nerezávitelného zabudovaného tělesa. Ramínko 180 mm.



M	00815301NM	368,00
M	00815301BM	368,00
M	00815301AC	368,00
24	00815301OR	445,00
24	00815301OM	445,00

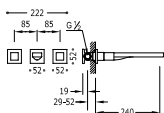

Single hole wall mixer
Built-in body is included and indivisible. Spout 240 mm.

Monoblocco a muro
 Corpo incassato incluso e indivisibile. Canna 240 mm.

Nástěnná umyvadlová baterie
 Včetně nerezávitelného zabudovaného tělesa. Ramínko 240 mm.



M	00815401NM	376,00
M	00815401BM	376,00
M	00815401AC	376,00
24	00815401OR	455,00
24	00815401OM	455,00

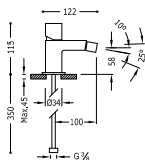

Single lever bidet mixer
Monocomando bidet
Jednopáková bidetová baterie



9130190

	00712001NM	237,00
	00712001BM	237,00
	00712001AC	237,00
	00712001OR	286,00
	00712001OM	286,00
	00712001NE	237,00
	00712001BL	237,00

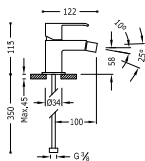

Single lever bidet mixer
Monocomando bidet
Jednopáková bidetová baterie



9130190

	00612001NM	237,00
	00612001BM	237,00
	00612001AC	237,00
	00612001OR	286,00
	00612001OM	286,00
	00612001NE	237,00
	00612001BL	237,00

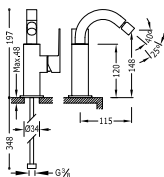

Single lever bidet mixer
Monocomando bidet
Jednopáková bidetová baterie



9130190

	00612402NM	332,00
	00612402BM	332,00
	00612402AC	332,00
	00612402OR	402,00
	00612402OM	402,00

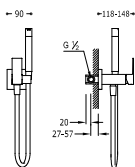

Concealed single lever bidet/toilets
Left or right support, interchangeable. Sateen hose.
Monocomando ad incasso per bidé WC
Supporto a destra o a sinistra, intercambiabile. Flesso satinato.



9130190

Jednopáková podomítková baterie pro bidet WC
Výměnitelný držák zprava či zleva. Sprchová mosazná baterie s omezovacím hrdlem 5 l/m. Systém proti kapání a flexi hadice SATIN

	00612301NM	281,00
	00612301BM	281,00
	00612301AC	281,00



Accessory towel racks
180 mm. (for Nr.: 00612301NM, 00612301BM, 00612301AC, 00612302NM, 00612302BM, 00612302AC). NOTE: Left or right support, interchangeable.

Accessori portasciugamani
180 mm. (per ref.: 00612301NM, 00612301BM, 00612301AC, 00612302NM, 00612302BM, 00612302AC). NOTA: Supporto a destra o a sinistra, intercambiabile.

Příslušenství držák na ručníky
180 mm. (Kód: 00612301NM, 00612301BM, 00612301AC, 00612302NM, 00612302BM, 00612302AC). POZNÁMKA: Právý nebo levý podstavec, výměnitelný.



	03412402NM	65,90
	03412402BM	65,90
	03412402AC	65,90



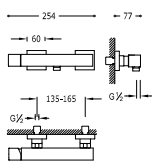

Single lever shower mixer
Anti-limescale hand shower with directable support. Shower hose SATIN.

Monocomando doccia
Doccetta anticalcare con supporto orientabile. Flessibile satin.
Jednopaková sprchová baterie
Ruční sprcha s nastavitelným držákem, proti usaz. vod. kamene. Flexi hadice SATIN.



M	00716703NM	438,00
M	00716703BM	438,00
	50716703	438,00
24	00716703OR	529,00
24	00716703OM	529,00
	607167	438,00
	407167	438,00

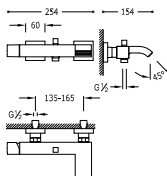

Single lever bath and shower mixer
with cascade. Anti-limescale hand shower with directable support. Shower hose SATIN.

Monocomando vasca
Con bocca a cascata. Doccetta anticalcare con supporto orientabile. Flessibile satin.
Jednopaková baterie pro vanu-sprchu
s kaskádou. Ruční sprcha s nastavitelným držákem, proti usaz. vod. kamene. Flexi hadice SATIN.



M	0071700203NM	499,00
M	0071700203BM	499,00
	5071700203	499,00
24	0071700203OR	604,00
24	0071700203OM	604,00
	60717002	499,00
	40717002	499,00

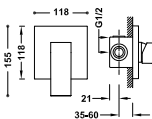

Built-in mixer taps RAPID-BOX (1 way)
Concealed body with buffers. ABS embedding box. Anti-moisture seal.

Monocomando incasso RAPID-BOX (1 via)
Corpo a incasso con smorzatori. Scatola da incasso in ABS. Guarnizione antiumidità.

Vestavěná jednopaková baterie RAPID-BOX (jednocestná)
Podomítkové těleso s tlumiči. Krabice ABS k zabudování do zdi. Těsnění proti vlhkosti.



M	10627701NM	188,00
M	10627701BM	188,00
	10627701AC	188,00
24	10627701OR	235,00
24	10627701OM	235,00

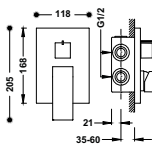

Built-in mixer taps RAPID-BOX (2 way)
Concealed body with buffers. ABS embedding box. Anti-moisture seal.

Monocomando incasso RAPID-BOX (2 vie)
Corpo a incasso con smorzatori. Scatola da incasso in ABS. Guarnizione antiumidità.

Vestavěná jednopaková baterie RAPID-BOX (dvoucestná)
Podomítkové těleso s tlumiči. Krabice ABS k zabudování do zdi. Těsnění proti vlhkosti.



M	10628001NM	328,00
M	10628001BM	328,00
	10628001AC	328,00
24	10628001OR	410,00
24	10628001OM	410,00

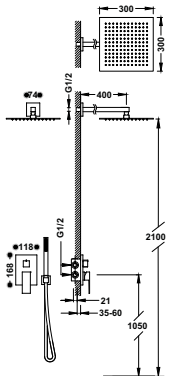

Concealed shower set RAPID-BOX

with water shut off and flow control.

- Built-in body included
- Stainless steel fixed shower head 300x300 mm. With ball joint.
- Elbow wall.
- Anti-limescale hand shower.
- Shower hose SATIN.

Kit doccia ad incasso RAPID-BOX

Con chiusura e regolazione di portata.

- Corpo incassato incluso
- Doccia fissa acciaio inossidabile 300x300 mm. con snodo.
- Supporto per doccia.
- Doccetta anticalcare.
- Flessibile satin.

Podomítkový jednopákový sprchový set RAPID-BOX

s uzávěrem a regulací průtoku.

- Včetně podomítkového tělesa
- Pevná sprcha 300x300 mm. s kloubem. Materiál nerez. oceli.
- Držák s nástěnným přívodem vody
- Ruční sprcha, proti usaz. vod. kamene.
- Flexi hadice SATIN.

	00628004NM	972,00
	00628004BM	972,00
	00628004AC	972,00
	00628004OR	1.178,00
	00628004OM	1.178,00

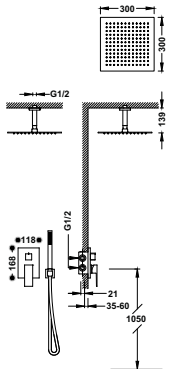

Concealed shower set RAPID-BOX

with water shut off and flow control.

- Built-in body included
- Stainless steel fixed shower head 300x300 mm. with ball joint.
- Elbow wall.
- Anti-limescale hand shower.
- Shower hose SATIN.

Kit doccia ad incasso RAPID-BOX

Con chiusura e regolazione di portata.

- Corpo incassato incluso
- Doccia fissa acciaio inossidabile 300x300 mm. con snodo.
- Supporto per doccia.
- Doccetta anticalcare.
- Flessibile satin.

Podomítkový jednopákový sprchový set RAPID-BOX

s uzávěrem a regulací průtoku.

- Včetně podomítkového tělesa
- Pevná sprcha 300x300 mm. s kloubem. Materiál nerez. oceli.
- Držák s nástěnným přívodem vody
- Ruční sprcha, proti usaz. vod. kamene.
- Flexi hadice SATIN.

	00628003NM	928,00
	00628003BM	928,00
	00628003AC	928,00
	00628003OR	1.125,00
	00628003OM	1.125,00

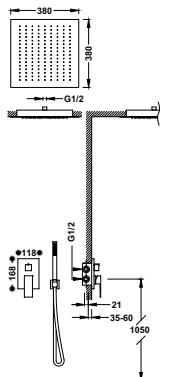

Concealed shower set RAPID-BOX

with water shut off and flow control.

- Built-in body included
- Steel shower head 380x380 mm.
- Elbow wall.
- Anti-limescale hand shower.
- Shower hose SATIN.

Kit doccia ad incasso RAPID-BOX

Con chiusura e regolazione di portata.

- Corpo incassato incluso
- Soffione doccia acciaio inossidabile 380x380 mm.
- Supporto per doccia.
- Doccetta anticalcare.
- Flessibile satin.

Podomítkový jednopákový sprchový set RAPID-BOX

s uzávěrem a regulací průtoku.

- Včetně podomítkového tělesa
- Sprchové hrobitko z nerez. oceli 380x380 mm.
- Držák s nástěnným přívodem vody
- Ruční sprcha, proti usaz. vod. kamene.
- Flexi hadice SATIN.

	00628005NM	1.445,00
	00628005BM	1.445,00
	00628005AC	1.445,00
	00628005OR	1.751,00
	00628005OM	1.751,00



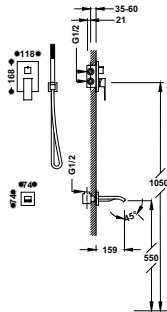

Concealed shower set RAPID-BOX

- with water shut off and flow control.
- Built-in body included.
- Bath spout.
- Elbow wall.
- Anti-limescale hand shower.
- Shower hose SATIN.

Kit doccia ad incasso RAPID-BOX

- Con chiusura e regolazione di portata.
- Corpo incassato incluso.
- Canna per vasca da bagno.
- Supporto per doccia.
- Doccia anticalcare.
- Flessibile satin.

Podomítkový jednopákový sprchový set RAPID-BOX

- s uzávěrem a regulací průtoku.
- Včetně podomítkového tělesa.
- Kohoutek pro vanu.
- Držák s nástěnným přívodem vody.
- Ruční sprcha, proti usaz. vod. kamene.
- Flexi hadice SATIN.

M	00628006NM	473,00
M	00628006BM	473,00
M	00628006AC	473,00
Z	00628006OR	573,00
Z	00628006OM	573,00



DECK-MOUNTED BATHTUBS | BORDOVASCA | VANY S PRODLOUŽENÝM PULTEM

Bath-shower single lever tap for bracket shelf with shower Anti-limescale.

- Flowrate: 3 bar – 13 l/m.
- Spout 180 mm.

Monocomando bordo vasca

- con doccetta anticalcare.
- Portata: 3 bar – 13 l/m.
- Canna 180 mm.

Jednopáková vanová stojánková baterie

- Sprcha, proti usaz. vod. kamene.
- Průtok: 3 bar – 13 l/m
- Ramínko 180 mm.

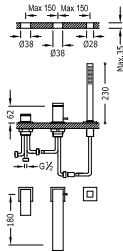

M	00616105NM	658,00
M	00616105BM	658,00
M	00616105AC	658,00
Z	00616105OR	797,00
Z	00616105OM	797,00



Bath-shower single lever tap for bracket shelf with shower Anti-limescale.

- Flowrate: 3 bar – 13 l/m.
- Spout 220 mm.

Monocomando bordo vasca

- con doccetta anticalcare.
- Portata: 3 bar – 13 l/m.
- Canna 220 mm.

Jednopáková vanová stojánková baterie

- Sprcha, proti usaz. vod. kamene.
- Průtok: 3 bar – 13 l/m
- Ramínko 220 mm.

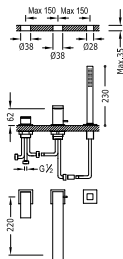

M	00616103NM	695,00
M	00616103BM	695,00
M	00616103AC	695,00
Z	00616103OR	843,00
Z	00616103OM	843,00





Wall thermostatic shower mixer
Anti-limescale hand shower with directable support. Shower hose SATIN.

29931201NM	29931201OM
29931201BM	910616116
910616153	910616114
29931201OR	

Doccia termostatica
Doccetta anticalcare con supporto orientabile. Flessibile satin.

Termostatická sprchová baterie
Ruční sprcha s nastavitelným držákem, proti usaz. vod. kamene.
Flexi hadice SATIN.

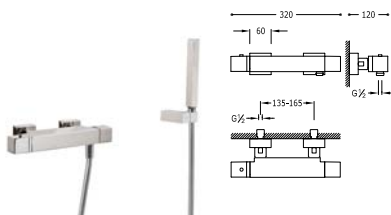

M	007164039NM	561,00
M	007164039BM	561,00
24	507164039	502,00
24	007164039OR	680,00
24	007164039OM	680,00
24	6071649	561,00
24	4071649	561,00



Wall thermostatic bath and shower mixer
with cascade. Anti-limescale hand shower with directable support. Shower hose SATIN. Diverter integrated in the flow control.

29931201NM	29931201OM
29931201BM	910616116
910616153	910616114
29931201OR	

Vasca-Doccia termostatica
Con bocca a cascata. Doccetta anticalcare con supporto orientabile. Flessibile satin. Invertitore integrato nel regolatore di portata.

Termostatická baterie pro vanu a sprchu
s kaskádou. Ruční sprcha s nastavitelným držákem, proti usaz. vod. kamene. Flexi hadice SATIN. Přepínač zabudovaný v regulaci průtoku.

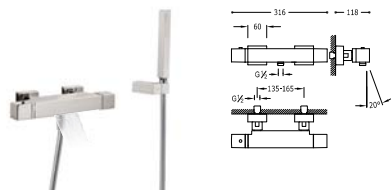

M	007174039NM	666,00
M	007174039BM	666,00
24	507174039	590,00
24	007174039OR	808,00
24	007174039OM	808,00
24	6071749	666,00
24	4071749	666,00



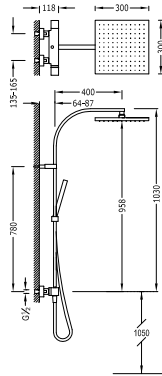

Wall thermostatic shower mixer

- Fixed shower head 300x300 mm. Brass.
- Anti-limescale hand shower.
- Shower hose SATIN.
- Diverter integrated in the flow control.

Set doccia termostatica

- Doccia fissa 300x300 mm. Ottone.
- Doccetta anticalcare.
- Flessibile satin.
- Invertitore integrato nel regolatore di portata.

Souprava termostatické sprchové baterie

- Pevná sprcha 300x300 mm. Materiál mosaz.
- Ruční sprcha, proti usaz. vod. kamene.
- Flexi hadičce SATIN.
- Přepínač zabudovaný v regulaci průtoku.

29931201NM 91061616
29931201BM 91061614
91061613



M	00739502NM	1.314,00
M	00739502BM	1.314,00
M	00739502AC	1.314,00
M	607395	1.314,00
M	407395	1.314,00

CONCEALED THERMOSTATIC MIXER | TERMOSTATICA AD INCASSO | PODOMÍTKOVÁ TERMOSTATICKÁ BATERIE

Concealed thermostatic shower kit BLOCK SYSTEM

with water shut off and flow control (2 ways).

- Built-in thermostatic body included.
- Stainless steel wall shower 210x550 mm.
- Anti-limescale hand shower.
- Shower hose SATIN.

2992504SNM 2992504SOM
2992504SBM 2992504SNE
2992504SAC 2992504SBL
2992504SOR

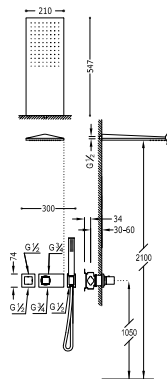

Kit doccia termostatica ad incasso BLOCK SYSTEM

Con chiusura e regolazione di portata (2 vie).

- Corpo incassato termostatico incluso.
- Doccia acciaio inossidabile da parete 210x550 mm.
- Doccetta anticalcare.
- Flessibile satin.

Termostatický podomítkový sprchový set BLOCK SYSTEM

- s uzávěrem a regulací průtoku (2-cestná).
- Včetně podomítkového termostatického tělesa.
- Nástěnné sprchové křepitko z nerez. oceli 210x550 mm.
- Ruční sprcha, proti usaz. vod. kamene.
- Flexi hadičce SATIN.

M	20725202NM	1.675,00
M	20725202BM	1.675,00
M	20725202AC	1.675,00
M	20725202OR	2.029,00
M	20725202OM	2.029,00
M	20725202NE	1.675,00
M	20725202BL	1.675,00



72 / Basin mixer taps | Lavabi | Koupelnová baterie



79 / Bidets | Bidet | Bidety



80 / Bathtub mixer taps | Monocomando esterno | Jednopákový mechanismus vany



81 / Built-in sets | Monocomando ad incasso | Vestavěné soupravy



85 / Single lever bath and shower mixer Monocomando vasca | Monocomando vasca | Vanová baterie



87 / Thermostatically-controlled | Termostatica | Termostatické



89 / Block System

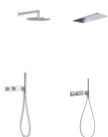

90 / Shower Technology



STUDY EXCLUSIVE



www.qrtr.es/study-exclusive



Chrome
Cromato
Chrom



Matt Black
Nero Opaco
Cerná mat



Matt White
Bianco Opaco
Bílá mat



Steel
Acciaio
Ocel



Metallic black
Nero metallizzato
Metalická černá barva



Brushed metallic black
Nero metallizzato spazzolato
Metalická černá barva hrubozrnná



Gold 24K
Oro 24K
Zlato 24K



Matt gold 24K
Oro 24K Opaco
Zlato 24K mat



Rose gold 24K
Oro rosa 24K
Růžové zlato 24K



Amber
Ambra
Jantarová



Orange
Arancione
Oranžová



Red
Rosso
Červená



Purple
Viola
Fialová



Fuchsia
Fucsia
Fuchsiová



Green
Verde
Zelená



Black
Nero
Černá



White
Bianco
Bílá



Single lever washbasin mixer
Monocomando lavabo
Jednopáková umyvadlová baterie

	26190301	134,00
	26190301D	152,00
	26190301NM	221,00
	26190301BM	221,00
	26190301AC	221,00
	26190301KM	221,00
	26190301KMB	221,00 N
	26190301OR	268,00
	26190301OM	268,00
	26190301OP	268,00 N
	26190301TAM	221,00
	26190301TNA	221,00
	26190301TRO	221,00
	26190301TVI	221,00
	26190301TFU	221,00
	26190301TVE	221,00
	26190301TNE	221,00
	26190301TBL	221,00

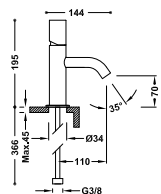

Single lever washbasin mixer
Monocomando lavabo
Jednopáková umyvadlová baterie

	26130701	232,00
	26130701NM	383,00
	26130701BM	383,00
	26130701AC	383,00
	26130701KM	383,00
	26130701KMB	383,00 N
	26130701OR	464,00
	26130701OM	464,00
	26130701OP	464,00 N
	26130701TAM	383,00
	26130701TNA	383,00
	26130701TRO	383,00
	26130701TVI	383,00
	26130701TFU	383,00
	26130701TVE	383,00
	26130701TNE	383,00
	26130701TBL	383,00

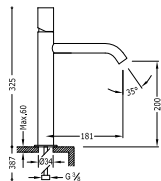

Single lever washbasin mixer
Monocomando lavabo
Jednopáková umyvadlová baterie

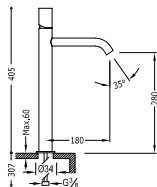

26130801	257,00
M 26130801NM	423,00
M 26130801BM	423,00
26130801AC	423,00
26130801OR	513,00
24 26130801OM	513,00
24 26130801OP	513,00 N
26130801TAM	423,00
26130801TNA	423,00
26130801TRO	423,00
26130801TVI	423,00
26130801TFU	423,00
26130801TVE	423,00
26130801TNE	423,00
26130801TBL	423,00

Single lever washbasin mixer
Monocomando lavabo
Jednopáková umyvadlová baterie

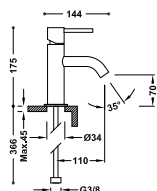

26290301	134,00
M 26290301D	152,00
M 26290301NM	221,00
M 26290301BM	221,00
26290301AC	221,00
26290301KM	221,00
26290301KMB	221,00 N
24 26290301OR	268,00
24 26290301OM	268,00
24 26290301OP	268,00 N
26290301TAM	221,00
26290301TNA	221,00
26290301TRO	221,00
26290301TVI	221,00
26290301TFU	221,00
26290301TVE	221,00
26290301TNE	221,00
26290301TBL	221,00

Single lever washbasin mixer
Monocomando lavabo
Jednopáková umyvadlová baterie

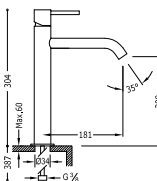

26230701	232,00
M 26230701NM	383,00
M 26230701BM	383,00
26230701AC	383,00
26230701KM	383,00
26230701KMB	383,00 N
24 26230701OR	464,00
24 26230701OM	464,00
24 26230701OP	464,00 N
26230701TAM	383,00
26230701TNA	383,00
26230701TRO	383,00
26230701TVI	383,00
26230701TFU	383,00
26230701TVE	383,00
26230701TNE	383,00
26230701TBL	383,00

Single lever washbasin mixer
Monocomando lavabo
Jednopáková umyvadlová baterie

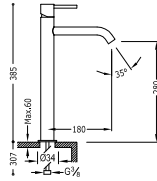

■	26230801	257,00
■	26230801NM	423,00
M	26230801BM	423,00
■	26230801AC	423,00
24	26230801OR	513,00
24	26230801OM	513,00
24	26230801OP	513,00 N
■	26230801TAM	423,00
■	26230801TNA	423,00
■	26230801TRO	423,00
■	26230801TVI	423,00
■	26230801TFU	423,00
■	26230801TVE	423,00
■	26230801TNE	423,00
■	26230801TBL	423,00



Single lever washbasin mixer
Monocomando lavabo
Jednopáková umyvadlová baterie

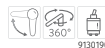
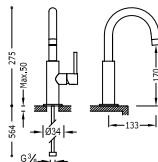

■	26290403	170,00
■	26290403NM	281,00
M	26290403BM	281,00
■	26290403AC	281,00
■	26290403KM	281,00
■	26290403KMB	281,00 N
24	26290403OR	340,00
24	26290403OM	340,00
24	26290403OP	340,00 N
■	26290403TAM	281,00
■	26290403TNA	281,00
■	26290403TRO	281,00
■	26290403TVI	281,00
■	26290403TFU	281,00
■	26290403TVE	281,00
■	26290403TNE	281,00
■	26290403TBL	281,00



Single lever washbasin mixer
Monocomando lavabo
Jednápáková umyvadlová baterie

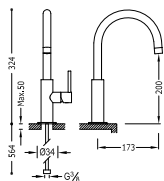

■	26290402	176,00
■ M	26290402NM	292,00
■ M	26290402BM	292,00
■	26290402AC	292,00
■	26290402KM	292,00
■	26290402KMB	292,00
■	26290402OR	352,00
■	26290402OM	352,00
■	26290402OP	352,00
■	26290402TAM	292,00
■	26290402TNA	292,00
■	26290402TRO	292,00
■	26290402TVI	292,00
■	26290402TFU	292,00
■	26290402TVE	292,00
■	26290402TNE	292,00
■	26290402TBL	292,00

Single lever washbasin mixer
Monocomando lavabo
Jednápáková umyvadlová baterie

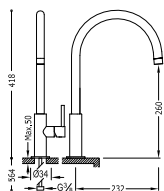

■	26290401	181,00
■ M	26290401NM	300,00
■ M	26290401BM	300,00
■	26290401AC	300,00
■	26290401KM	300,00
■	26290401KMB	300,00
■	26290401OR	363,00
■	26290401OM	363,00
■	26290401OP	363,00
■	26290401TAM	300,00
■	26290401TNA	300,00
■	26290401TRO	300,00
■	26290401TVI	300,00
■	26290401TFU	300,00
■	26290401TVE	300,00
■	26290401TNE	300,00
■	26290401TBL	300,00



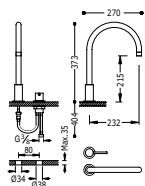

Deck-mounted washbasin mixer tap
Free installation.

Monocomando lavabo a mensola
Ad installazione libera.

Páková baterie k umyvadlu
Možnost samostatné instalace.

	26110501	180,00
	26110501NM	298,00
	26110501BM	298,00
	26110501AC	298,00
	26110501KM	298,00
	26110501KMB	298,00 N
	26110501OR	361,00
	26110501OM	361,00
	26110501OP	361,00 N

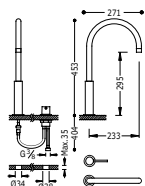

Deck-mounted washbasin mixer tap
Free installation.

Monocomando lavabo a mensola
Ad installazione libera.

Páková baterie k umyvadlu
Možnost samostatné instalace.

	26110502	185,00
	26110502NM	306,00
	26110502BM	306,00
	26110502AC	306,00
	26110502KM	306,00
	26110502KMB	306,00 N
	26110502OR	371,00
	26110502OM	371,00
	26110502OP	371,00 N

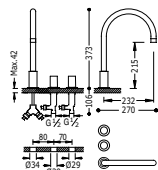

Counter-top dual control tap
Free installation.

Doppio comando a mensola
Ad installazione libera.

Kohoutková stojánková vanová baterie
Možnost samostatné instalace.

	06110501	213,00
	06110501NM	352,00
	06110501BM	352,00
	06110501AC	352,00
	06110501KM	352,00
	06110501KMB	352,00 N
	06110501OR	426,00
	06110501OM	426,00
	06110501OP	426,00 N

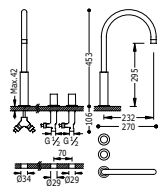

Counter-top dual control tap
Free installation.

Doppio comando a mensola
Ad installazione libera.

Kohoutková stojánková vanová baterie
Možnost samostatné instalace.

	06110502	218,00
	06110502NM	361,00
	06110502BM	361,00
	06110502AC	361,00
	06110502KM	361,00
	06110502KMB	361,00 N
	06110502OR	437,00
	06110502OM	437,00
	06110502OP	437,00 N



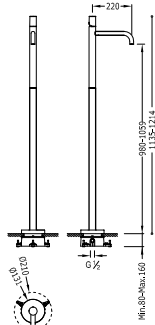

Standing tap
Built-in body included.
 Lavabo con piede a terra
 Corpo incassato incluso.
 Umyvadlo s podstavcem
 Včetně podomítkového tělesa.



■	26285302	567,00
■ M	26285302NM	935,00
■ M	26285302BM	935,00
■	26285302AC	935,00
■ 24	26285302OR	1.133,00
■ 24	26285302OM	1.133,00
■ 24	26285302OP	1.133,00 N

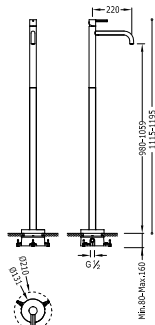

Standing tap
Built-in body included.
 Lavabo con piede a terra
 Corpo incassato incluso.
 Umyvadlo s podstavcem
 Včetně podomítkového tělesa.



■	26285301	567,00
■ M	26285301NM	935,00
■ M	26285301BM	935,00
■	26285301AC	935,00
■ 24	26285301OR	1.133,00
■ 24	26285301OM	1.133,00
■ 24	26285301OP	1.133,00 N



Single lever wall washbasin mixer

Indivisible concealed body with buffers. Anti-moisture seal. Short spout 180 mm.

Monomando a muro

Corpo a incasso indivisibile con smorzatori. Guarnizione antiumidità. Canna corta 180 mm.

Jednopávková nástěnná baterie

Podomítkové těleso v nedělitelném provedení s tlumiči. Těsnění proti vlhkosti. Krátké ramínko 180 mm

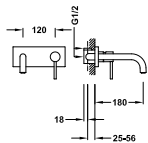

29902801

	26230011	242,00
	26230011NM	399,00
	26230011BM	399,00
	26230011AC	399,00
	26230011KM	399,00
	26230011KMB	399,00
	26230011OR	484,00
	26230011OM	484,00
	26230011OP	484,00

Single lever wall washbasin mixer

Indivisible concealed body with buffers. Anti-moisture seal. Short spout 240 mm.

Monomando a muro

Corpo a incasso indivisibile con smorzatori. Guarnizione antiumidità. Canna corta 240 mm.

Jednopávková nástěnná baterie

Podomítkové těleso v nedělitelném provedení s tlumiči. Těsnění proti vlhkosti. Krátké ramínko 240 mm

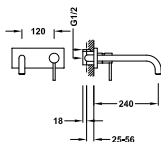

29902801

	26230012	252,00
	26230012NM	416,00
	26230012BM	416,00
	26230012AC	416,00
	26230012KM	416,00
	26230012KMB	416,00
	26230012OR	505,00
	26230012OM	505,00
	26230012OP	505,00

Single lever wall washbasin mixer

Indivisible concealed body with buffers. Anti-moisture seal. Short spout 177 mm.

Monomando a muro

Corpo a incasso indivisibile con smorzatori. Guarnizione antiumidità. Canna corta 177 mm.

Jednopávková nástěnná baterie

Podomítkové těleso v nedělitelném provedení s tlumiči. Těsnění proti vlhkosti. Krátké ramínko 177 mm

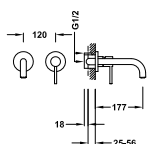

29902801

	26230001	207,00
	26230001NM	342,00
	26230001BM	342,00
	26230001AC	342,00
	26230001KM	342,00
	26230001KMB	342,00
	26230001OR	414,00
	26230001OM	414,00
	26230001OP	414,00

Single lever wall washbasin mixer

Indivisible concealed body with buffers. Anti-moisture seal. Short spout 237 mm.

Monomando a muro

Corpo a incasso indivisibile con smorzatori. Guarnizione antiumidità. Canna corta 237 mm.

Jednopávková nástěnná baterie

Podomítkové těleso v nedělitelném provedení s tlumiči. Těsnění proti vlhkosti. Krátké ramínko 237 mm

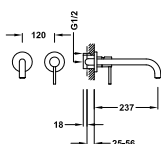















29902801

	26230002	217,00
	26230002NM	358,00
	26230002BM	358,00
	26230002AC	358,00
	26230002KM	358,00
	26230002KMB	358,00
	26230002OR	435,00
	26230002OM	435,00
	26230002OP	435,00



Single lever bidet mixer
Monocomando bidet
Jednopáková bidetová baterie



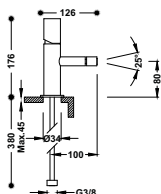

	26112001	132,00
	26112001D	149,00

	06112001NM	216,00
	06112001BM	216,00
	06112001AC	216,00
	06112001KM	216,00
	06112001KMB	216,00 N
	06112001OR	262,00
	06112001OM	262,00 N
	06112001OP	262,00
	06112001TAM	216,00
	06112001TNA	216,00
	06112001TRO	216,00
	06112001TVI	216,00
	06112001TFU	216,00
	06112001TVE	216,00
	06112001TNE	216,00
	06112001TBL	216,00



Single lever bidet mixer
Monocomando bidet
Jednopáková bidetová baterie





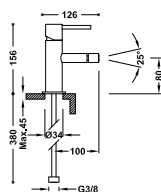







	26212001	132,00
	26212001D	149,00

	06212001NM	216,00
	06212001BM	216,00
	06212001AC	216,00
	06212001KM	216,00
	06212001KMB	216,00 N
	06212001OR	262,00
	06212001OM	262,00 N
	06212001OP	262,00
	06212001TAM	216,00
	06212001TNA	216,00
	06212001TRO	216,00
	06212001TVI	216,00
	06212001TFU	216,00
	06212001TVE	216,00
	06212001TNE	216,00
	06212001TBL	216,00



Single lever bidet mixer
Monocomando bidet
Jednopáková bidetová baterie

	26222402	164,00
---	----------	--------

	26222402NM	271,00
	26222402BM	271,00
	26222402AC	271,00
	26222402KM	271,00
	26222402KMB	271,00 N
	26222402OR	328,00
	26222402OM	328,00
	26222402OP	328,00 N
	26222402TAM	271,00
	26222402TNA	271,00
	26222402TRO	271,00
	26222402TVI	271,00
	26222402TFU	271,00
	26222402TVE	271,00
	26222402TNE	271,00
	26222402TBL	271,00

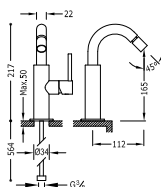

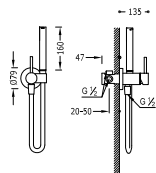

Concealed single lever bidet/toilets
Left or right support, interchangeable. Sateen hose.

Monocomando ad incasso per bidé WC
Supporto a destra o a sinistra, intercambiabile. Flesso satinato.

Jednopáková podomítková baterie pro bidet WC
Vyměnitelný držák zprava či zleva. Sprchová mosazná baterie s omezovacím hrdlem 5 l/m. Systém proti kapání a flexi hadice SATIN



M	134123NM	263,00
M	134123BM	263,00
M	134123AC	263,00



Accessory towel racks
180 mm. (for Nr.: 34123, 34122, 20522301, 20522201). NOTE: Left or right support, interchangeable.

Accessori portasciugamani
180 mm. (per ref.: 34123, 34122, 20522301, 20522201). NOTA: Supporto a destra o a sinistra, intercambiabile.

Příslušenství držák na ručníky
180 mm. (Kód: 34123, 34122, 20522301, 20522201). POZNÁMKA: Pravý nebo levý podstavec, vyměnitelný.



M	03412401NM	52,80
M	03412401BM	52,80
M	03412401AC	52,80

BATHTUB MIXER TAPS | MONOCOMANDI BAGNO | JEDNOPÁKOVÝ MECHANISMUS VANY



Single lever shower mixer
Anti-limescale hand shower with directable support. Shower hose SATIN.

Monocomando doccia
Doccetta anticalcare con supporto orientabile. Flessibile satin.

Sprchová baterie
Ruční sprcha s nastavitelným držákem, proti usaz. vod. kamene.
Flexi hadice SATIN.

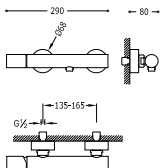

(1)	26116701	211,00
(1)	M 26116701NM	349,00
(1)	M 26116701BM	349,00
(1)	M 26116701AC	349,00
(1)	M 26116701KM	349,00
(1)	M 26116701KMB	349,00
(1)	24 26116701OR	422,00
(1)	24 26116701OM	422,00
(1)	24 26116701OP	422,00
(1)	M 26116701TAM	349,00
(1)	M 26116701TNA	349,00
(1)	M 26116701TRO	349,00
(1)	M 26116701TVI	349,00
(1)	M 26116701TFU	349,00
(1)	M 26116701TVE	349,00
(1)	M 26116701TNE	349,00
(1)	M 26116701TBL	349,00



Single lever bath and shower mixer
Anti-limescale hand shower with directable support. Shower hose SATIN.

Monocomando vasca
Doccetta anticalcare con supporto orientabile. Flessibile satin.

Vanová baterie
Ruční sprcha s nastavitelným držákem, proti usaz. vod. kamene.
Flexi hadice SATIN.

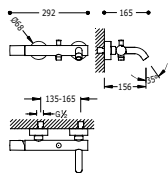

(1)	■	26117001	240,00
(1)	■	26117001NM	397,00
(1)	■	M 26117001BM	397,00
(1)	■	26117001AC	397,00
(1)	■	26117001KM	397,00
(1)	■	26117001KMB	397,00 N
(1)	■	24 26117001OR	480,00
(1)	■	24 26117001OM	480,00
(1)	■	24 26117001OP	480,00 N
(1)	■	26117001TAM	397,00
(1)	■	26117001TNA	397,00
(1)	■	26117001TRO	397,00
(1)	■	26117001TVI	397,00
(1)	■	26117001TFU	397,00
(1)	■	26117001TVE	397,00
(1)	■	26117001TNE	397,00
(1)	■	26117001TBL	397,00

BUILT-IN SETS | GRUPPI AD INCASSO | VESTAVĚNÉ SOUPRAVY

Built-in mixer taps RAPID-BOX (1 way)
Concealed body with buffers. ABS embedding box. Anti-moisture seal.

Monocomando incasso RAPID-BOX (1 via)
Corpo a incasso con smorzatori. Scatola da incasso in ABS.
Guarnizione antiumidità.

Vestavěná jednopáková baterie RAPID-BOX (jednocestný)
Podomítkové těleso s tlumiči. Krabice ABS k zabudování do zdi.
Těsnění proti vlhkosti.



■	26227701	99,90
■	M 26227701NM	160,00
■	M 26227701BM	160,00
■	26227701AC	160,00
■	26227701KM	160,00
■	26227701KMB	160,00
■	24 26227701OR	200,00
■	24 26227701OM	200,00
■	24 26227701OP	200,00

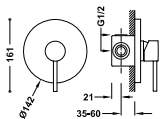

Built-in mixer taps RAPID-BOX (2 way)
Concealed body with buffers. ABS embedding box. Anti-moisture seal.

Monocomando incasso RAPID-BOX (2 vie)
Corpo a incasso con smorzatori. Scatola da incasso in ABS.
Guarnizione antiumidità.

Vestavěná jednopáková baterie RAPID-BOX (dvoucestný)
Podomítkové těleso s tlumiči. Krabice ABS k zabudování do zdi.
Těsnění proti vlhkosti.



■	26228001	176,00
■	M 26228001NM	282,00
■	M 26228001BM	282,00
■	26228001AC	282,00
■	26228001KM	282,00
■	26228001KMB	282,00
■	24 26228001OR	352,00
■	24 26228001OM	352,00
■	24 26228001OP	352,00

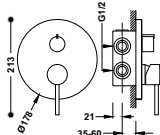

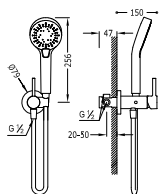

Concealed shower set

- with water shut off and flow control.
- Built-in body included
- Left or right support, interchangeable.
- Massage hand shower Ø 110 mm. (3 jet types).
- Shower hose SATIN.

Kit doccia ad incasso

- Con chiusura e regolazione di portata.
- Corpo incassato incluso
- Supporto a destra o a sinistra, intercambiabile.
- Doccetta Ø 110 mm. (3 tipi di getto).
- Flessibile satin.

Podomítkový jednopávkový sprchový set

- s uzávěrem a regulací průtoku.
- Včetně podomítkového tělesa
- Vyměnitelný držák zprava či zleva.
- Ruční masážní sprcha Ø 110 mm. (3 typů proudění vody).
- Flexi hadice SATIN.



26212301

139,00

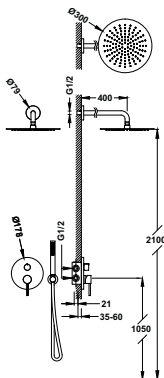

Concealed shower set RAPID-BOX

- with water shut off and flow control.
- Built-in body included
- Stainless steel fixed shower head Ø 300 mm. With ball joint.
- Elbow wall.
- Anti-limescale hand shower.
- Shower hose SATIN.

Kit doccia ad incasso RAPID-BOX

- Con chiusura e regolazione di portata.
- Corpo incassato incluso
- Doccia fissa acciaio inossidabile Ø 300 mm. con snodo.
- Supporto per doccia.
- Doccetta anticalcare.
- Flessibile satin.

Podomítkový jednopávkový sprchový set RAPID-BOX

- s uzávěrem a regulací průtoku.
- Včetně podomítkového tělesa
- Pevná sprcha Ø 300 mm. s kloubem. Materiál nerez. oceli.
- Držák s nástěnným přívodem vody
- Ruční sprcha, proti usaz. vod. kamene.
- Flexi hadice SATIN.

26228004

481,00

M	26228004NM	794,00
M	26228004BM	794,00
M	26228004AC	794,00
M	26228004KM	794,00
M	26228004KMB	794,00
M	26228004OR	962,00
M	26228004OM	962,00
M	26228004OP	962,00



Concealed shower set RAPID-BOX

- with water shut off and flow control.
- Built-in body included
- Stainless steel fixed shower head Ø 300 mm. With ball joint.
- Elbow wall.
- Anti-limescale hand shower Ø 110 mm. (3 jet types).
- Shower hose SATIN.

Kit doccia ad incasso RAPID-BOX

- Con chiusura e regolazione di portata.
- Corpo incassato incluso
- Doccia fissa acciaio inossidabile Ø 300 mm. con snodo.
- Supporto per doccia.
- Doccetta anticalcare Ø 110 mm. (3 tipi di getto).
- Flessibile satin.

Podomítkový jednopávkový sprchový set RAPID-BOX

- s uzávěrem a regulací průtoku.
- Včetně podomítkového tělesa
- Pevná sprcha Ø 300 mm. s kloubem. Materiál nerez. oceli.
- Držák s nástěnným přívodem vody
- Ruční sprcha, proti usaz. vod. Kamene Ø 110 mm. (3 typů proudění vody).
- Flexi hadice SATIN.

26228040

481,00

M	26228040NM	794,00
M	26228040BM	794,00
M	26228040AC	794,00
M	26228040KM	794,00
M	26228040KMB	794,00
M	26228040OR	962,00
M	26228040OM	962,00
M	26228040OP	962,00



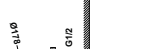
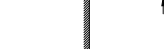
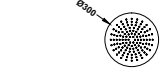

Concealed shower set RAPID-BOX

with water shut off and flow control.

- Built-in body included
- Stainless steel fixed shower head Ø 300 mm. with ball joint.
- Elbow wall.
- Anti-limescale hand shower.
- Shower hose SATIN.

Kit doccia ad incasso RAPID-BOX

Con chiusura e regolazione di portata.

- Corpo incassato incluso
- Doccia fissa acciaio inossidabile Ø 300 mm. con snodo.
- Supporto per doccia.
- Doccetta anticalcare.
- Flessibile satin.

Podomítkový jednopákový sprchový set RAPID-BOX

s uzávěrem a regulací průtoku.

- Včetně podomítkového tělesa
- Pevná sprcha Ø 300 mm. s kloubem. Materiál nerez. oceli.
- Držák s nástěnným přívodem vody.
- Ruční sprcha, proti usaz. vod. Kamene.
- Flexi hadice SATIN.

26228003

461,00

M 26228003NM

761,00

M 26228003BM

761,00

M 26228003AC

761,00

M 26228003KM

761,00

M 26228003KMB

761,00

M 26228003OR

923,00

M 26228003OM

923,00

M 26228003OP

923,00

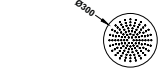

Concealed shower set RAPID-BOX

with water shut off and flow control.

- Built-in body included
- Stainless steel fixed shower head Ø 110 mm. with ball joint.
- Elbow wall.
- Anti-limescale hand shower Ø 110 mm. (3 jet types).
- Shower hose SATIN.

Kit doccia ad incasso RAPID-BOX

Con chiusura e regolazione di portata.

- Corpo incassato incluso
- Doccia fissa acciaio inossidabile Ø 300 mm. con snodo.
- Supporto per doccia.
- Doccetta anticalcare Ø 110 mm. (3 tipi di getto).
- Flessibile satin.

Podomítkový jednopákový sprchový set RAPID-BOX

s uzávěrem a regulací průtoku.

- Včetně podomítkového tělesa
- Pevná sprcha Ø 300 mm. s kloubem. Materiál nerez. oceli.
- Držák s nástěnným přívodem vody.
- Ruční sprcha, proti usaz. vod. Kamene Ø 110 mm. (3 typů proudění vody).
- Flexi hadice SATIN.

26228030

461,00

M 26228030NM

761,00

M 26228030BM

761,00

M 26228030AC

761,00

M 26228030KM

761,00

M 26228030KMB

761,00

M 26228030OR

923,00

M 26228030OM

923,00

M 26228030OP

923,00

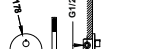
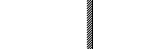
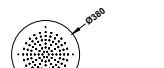

Concealed shower set RAPID-BOX

with water shut off and flow control.

- Built-in body included
- Steel shower head Ø 380 mm.
- Elbow wall.
- Anti-limescale hand shower.
- Shower hose SATIN.

Kit doccia ad incasso RAPID-BOX

Con chiusura e regolazione di portata.

- Corpo incassato incluso
- Soffione doccia acciaio inossidabile Ø 380 mm.
- Supporto per doccia.
- Doccetta anticalcare.
- Flessibile satin.

Podomítkový jednopákový sprchový set RAPID-BOX

s uzávěrem a regulací průtoku.

- Včetně podomítkového tělesa
- Sprchové hrožpítka z nerez. oceli Ø 380 mm.
- Držák s nástěnným přívodem vody.
- Ruční sprcha, proti usaz. vod. kamene.
- Flexi hadice SATIN.

26228005

915,00

M 26228005NM

1509,00

M 26228005BM

1509,00

M 26228005AC

1509,00

M 26228005KM

1509,00

M 26228005KMB

1509,00

M 26228005OR

1829,00

M 26228005OM

1829,00

M 26228005OP

1829,00



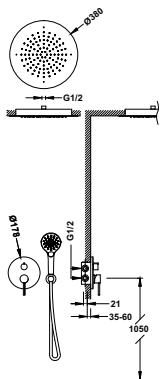

Concealed shower set RAPID-BOX

- with water shut off and flow control.
- Built-in body included
- Steel shower head Ø 380 mm.
- Elbow wall.
- Anti-limescale hand shower Ø 110 mm. (3 jet types).
- Shower hose SATIN.

Kit doccia ad incasso RAPID-BOX

- Con chiusura e regolazione di portata.
- Corpo incassato incluso
- Soffione doccia acciaio inossidabile Ø 380 mm.
- Supporto per doccia.
- Doccetta anticalcare Ø 110 mm. (3 tipi di getto).
- Flessibile satin.

Podomítkový jednopávkový sprchový set RAPID-BOX

- s uzávěrem a regulací průtoku.
- Včetně podomítkového tělesa
- Sprchové křepítka z nerez. oceli Ø 380 mm.
- Držák s nástěnným přívodem vody.
- Ruční sprcha, proti usaz. vod. Kamene Ø 110 mm. (3 typů proudění vody).
- Flexi hadice SATIN.



■	26228050	915,00
■	26228050NM	1.509,00
■	26228050BM	1.509,00
■	26228050AC	1.509,00
■	26228050KM	1.509,00
■	26228050KMB	1.509,00
■	26228050OR	1.829,00
■	26228050OM	1.829,00
■	26228050OP	1.829,00

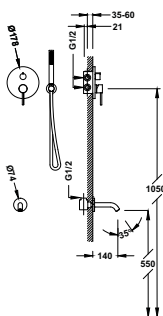

Concealed shower set RAPID-BOX

- with water shut off and flow control.
- Built-in body included.
- Bath spout.
- Elbow wall.
- Anti-limescale hand shower.
- Shower hose SATIN.

Kit doccia ad incasso RAPID-BOX

- Con chiusura e regolazione di portata.
- Corpo incassato incluso.
- Canna per vasca da bagno.
- Supporto per doccia.
- Doccetta anticalcare.
- Flessibile satin.

Podomítkový jednopávkový sprchový set RAPID-BOX

- s uzávěrem a regulací průtoku.
- Včetně podomítkového tělesa.
- Kohoutek pro vanu.
- Držák s nástěnným přívodem vody.
- Ruční sprcha, proti usaz. vod. kamene.
- Flexi hadice SATIN.



■	26228006	322,00
■	26228006NM	532,00
■	26228006BM	532,00
■	26228006AC	532,00
■	26228006KM	532,00
■	26228006KMB	532,00
■	26228006OR	645,00
■	26228006OM	645,00
■	26228006OP	645,00

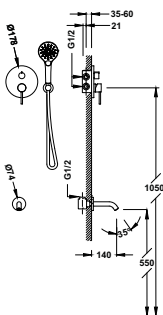

Concealed shower set RAPID-BOX

- with water shut off and flow control.
- Built-in body included.
- Bath spout.
- Elbow wall.
- Anti-limescale hand shower Ø 110 mm. (3 jet types).
- Shower hose SATIN.

Kit doccia ad incasso RAPID-BOX

- Con chiusura e regolazione di portata.
- Corpo incassato incluso.
- Canna per vasca da bagno.
- Supporto per doccia.
- Doccetta anticalcare Ø 110 mm. (3 tipi di getto).
- Flessibile satin.

Podomítkový jednopávkový sprchový set RAPID-BOX

- s uzávěrem a regulací průtoku.
- Včetně podomítkového tělesa.
- Kohoutek pro vanu.
- Držák s nástěnným přívodem vody.
- Ruční sprcha, proti usaz. vod. Kamene Ø 110 mm. (3 typů proudění vody).
- Flexi hadice SATIN.



■	26228060	322,00
■	26228060NM	532,00
■	26228060BM	532,00
■	26228060AC	532,00
■	26228060KM	532,00
■	26228060KMB	532,00
■	26228060OR	645,00
■	26228060OM	645,00
■	26228060OP	645,00

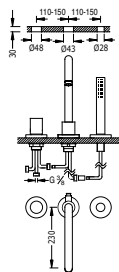

Bath-shower single lever tap for bracket shelf

- with shower Anti-limescale.
- Flowrate: 3 bar – 14 l/m.
- Compatible with tank kit ref: 162245.

Monocomando bordo vasca

- Doccetta anticalcare.
- Portata: 3 bar – 14 l/m.
- Compatibile con il kit serbatoio cod: 162245.

Jednopáková stojánková vanová baterie

- Sprcha, proti usaz. vod. Kamene.
- Průtok: 3 bar – 14 l/m
- Kompatibilní se sadou nádrže ref. č.: 162245.



26115001

432,00

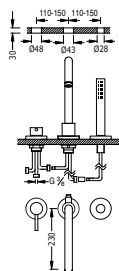

Bath-shower single lever tap for bracket shelf

- with shower Anti-limescale.
- Flowrate: 3 bar – 14 l/m.
- Compatible with tank kit ref: 162245.

Monocomando bordo vasca

- Doccetta anticalcare.
- Portata: 3 bar – 14 l/m.
- Compatibile con il kit serbatoio cod: 162245.

Jednopáková stojánková vanová baterie

- Sprcha, proti usaz. vod. Kamene.
- Průtok: 3 bar – 14 l/m
- Kompatibilní se sadou nádrže ref. č.: 162245.



26215001

432,00

06215001AC

713,00



Standing bath-shower mixer tap with two independent regulators. Built-in body included. Anti-limescale hand shower and shower hose SATIN.

Miscelatore monocomando verticale vasca da bagno-doccia

con due regolatori indipendenti. Corpo incassato incluso. Doccetta anticalcare con flessibile satin.

Vanová podlahová baterie páková se sprchou se dvěma nezávislými regulátory. Včetně podomítkového tělesa. Ruční sprcha a flexi hadice SATIN.

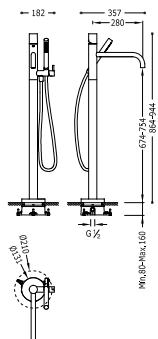

26247002 979,00

M 26247002NM 1.615,00

M 26247002BM 1.615,00

26247002AC 1.615,00

24 26247002OR 1.957,00

24 26247002OM 1.957,00

24 26247002OP 1.957,00 **N**



910719005 9134290

Standing bath-shower mixer tap with two independent regulators. Built-in body included. Anti-limescale hand shower and shower hose SATIN.

Miscelatore monocomando verticale vasca da bagno-doccia

con due regolatori indipendenti. Corpo incassato incluso. Doccetta anticalcare con flessibile satin.

Vanová podlahová baterie páková se sprchou se dvěma nezávislými regulátory. Včetně podomítkového tělesa. Ruční sprcha a flexi hadice SATIN.

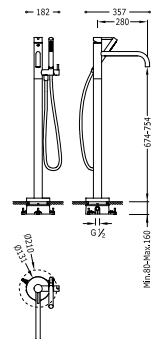

26247001 979,00

M 26247001NM 1.615,00

M 26247001BM 1.615,00

26247001AC 1.615,00

24 26247001OR 1.957,00

24 26247001OM 1.957,00

24 26247001OP 1.957,00 **N**



910719005 9134290



Wall thermostatic shower mixer
Anti-limescale hand shower with directable support and shower hose SATIN.

- | | | |
|------------|-------------|--|
| 29919503 | 29919503KMB | |
| 29919503NM | 29919503OR | |
| 29919503BM | 29919503OM | |
| 29919503AC | 29919503OP | |
| 29919503KM | | |

Doccia termostatica
Doccetta anticalcare con supporto orientabile. Flessibile satin.

Termostatická sprchová baterie
Ruční sprcha s nastavitelným držákem, proti usaz. vod. kamene a flexi hadice SATIN.

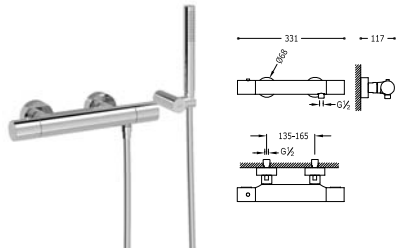

(1) 26116209 **274,00**

(1) M 26116209NM **452,00**

(1) M 26116209BM **452,00**

(1) M 26116209AC **452,00**

(1) M 26116209KM **452,00**

(1) M 26116209KMB **452,00**

(1) Z 26116209OR **548,00**

(1) Z 26116209OM **548,00**

(1) Z 26116209OP **548,00**



Wall thermostatic shower mixer
With cascade. Anti-limescale hand shower with directable support and shower hose SATIN. Diverter integrated in the flow control.

- | | | |
|------------|-------------|--|
| 29919503 | 29919503KMB | |
| 29919503NM | 29919503OR | |
| 29919503BM | 29919503OM | |
| 29919503AC | 29919503OP | |
| 29919503KM | | |

Vasca-Doccia termostatica
Con bocca a cascata. Doccetta anticalcare con supporto orientabile. Flessibile satin. Invertitore integrato nel regolatore di portata.

Termostatická baterie pro vanu-sprchu
s kaskádou. Ruční sprcha s nastavitelným držákem, proti usaz. vod. kamene a flexi hadice SATIN. Přepínač zabudovaný v regulaci průtoku.

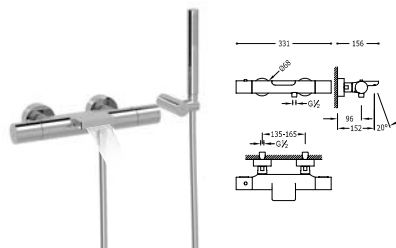

(1) 26117209 **335,00**

(1) M 26117209NM **553,00**

(1) M 26117209BM **553,00**

(1) M 26117209AC **553,00**

(1) M 26117209KM **553,00**

(1) M 26117209KMB **553,00**

(1) Z 26117209OR **670,00**

(1) Z 26117209OM **670,00**

(1) Z 26117209OP **670,00**



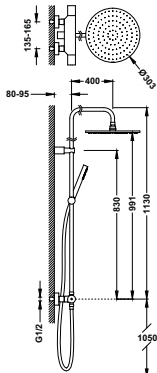

Wall thermostatic shower mixer

- Fixed shower head Ø 300 mm. with ball joint. Brass.
- Anti-limescale hand shower.
- Shower hose SATIN.
- Diverter integrated in the flow control.

Set doccia termostatica

- Doccia fissa Ø 300 mm. con snodo. Ottone.
- Doccetta anticalcare.
- Flessibile satin.
- Invertitore integrato nel regolatore di portata.

Souprava termostatické sprchové baterie

- Pevná sprcha Ø 300 mm. s kloboum. Materiál mosaz.
- Ruční sprcha, proti usaz. vod. Kamene.
- Flexi hadice SATIN.
- Přepínač zabudovaný v regulaci průtoku.

29919503
29919503BM
29919503BM
29919503AC

26238701 670,00

26238701NM 1.105,00

26238701BM 1.105,00

26238701AC 1.105,00

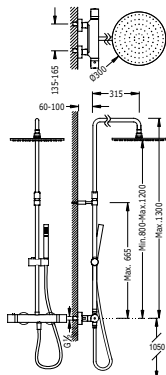

Wall thermostatic shower mixer

- Fixed shower head Ø 300 mm. with ball joint. Brass.
- Anti-limescale hand shower.
- Shower hose SATIN.
- Telescopic bar.
- Diverter integrated in the flow control.

Set doccia termostatica

- Doccia fissa Ø 300 mm. con snodo. Ottone.
- Doccetta anticalcare.
- Flessibile satin.
- Asta telescopica.
- Invertitore integrato nel regolatore di portata.

Souprava termostatické sprchové baterie

- Pevná sprcha Ø 300 mm. s kloboum. Materiál mosaz.
- Ruční sprcha, proti usaz. vod. Kamene.
- Flexi hadice SATIN.
- Teleskopická tyč.
- Přepínač zabudovaný v regulaci průtoku.

26121001 721,00

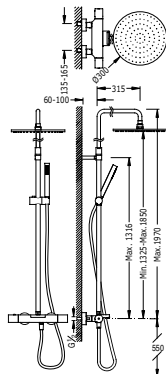

Wall thermostatic shower mixer (3 ways)

- Fixed shower head Ø 300 mm. with ball joint. Brass.
- Anti-limescale hand shower.
- Shower hose SATIN.
- Telescopic bar.
- Diverter integrated in the flow control.

Vasca-Doccia termostatica (3 vie)

- Doccia fissa Ø 300 mm. con snodo. Ottone.
- Doccetta anticalcare.
- Flessibile satin.
- Asta telescopica.
- Invertitore integrato nel regolatore di portata.

Souprava termostatické baterie pro vanu-sprchu (3-cestná)

- Pevná sprcha Ø 300 mm. s kloboum. Materiál mosaz.
- Ruční sprcha, proti usaz. vod. Kamene.
- Flexi hadice SATIN.
- Teleskopická tyč.
- Přepínač zabudovaný v regulaci průtoku.

26231201 802,00



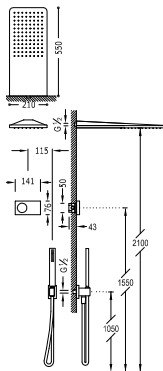

Built-in electronic thermostatic shower kit SHOWER TECHNOLOGY BLUE EDITION

- Electronic control included with Schlüter anti-moisture seals.
- Electronic thermostatic control box included (2 ways).
- Stainless steel wall shower 210x550 mm.
- Elbow wall.
- Antilime hand shower.
- Shower hose SATIN.

Kit elettronico per doccia termostatica da incasso SHOWER TECHNOLOGY BLUE EDITION

- Controllo elettronico incluso con guarnizioni anti-umidità Schlüter.
- Centralina termostatica elettronica inclusa (2 vie).
- Doccia acciaio inossidabile da parete 210x550 mm.
- Supporto per doccia.
- Doccetta anticalcare.
- Flessibile satin.

Termostatický podomítkový elektronický sprchový set SHOWER TECHNOLOGY BLUE EDITION

- Součástí kontrolní skříňka s těsněním od firmy Schlüter.
- Zabudovaná termostatická elektronická kontrolní jednotka (2-cestná).
- Nástěnné sprchové křepítka z nerez. oceli 210x550 mm.
- Držák s nástěnným přívodem vody.
- Ruční sprcha, proti usaz. vod. kamene.
- Flexi hadice SATIN.



09286554 **1.109,00**

M 09286554BM **1.596,00**

09286554AC **1.596,00**



09288554 **1.109,00**

M 09288554NM **1.596,00**

09288554AC **1.596,00**

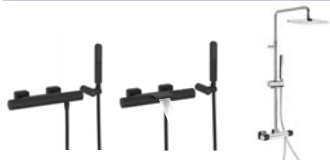

94 / **Basin mixer taps** | Lavabi | Koupelnová baterie100 / **Bidets** | Bidet | Bidety102 / **Bathtub mixer taps** | Monocomando esterno | Jednopákový mechanismus vany103 / **Built-in sets** | Monocomando ad incasso | Vestavěné soupravy104 / **Deck-mounted bathtubs** | Bordovasca | Vany s prodlouženým pultem104 / **Thermostatically-controlled** | Termostatica | Termostatické106 / **Block System**

LOFT COLORS



www.qtr.es/loft-colors

F



Matt Black
Nero Opaco
Černá mat



Matt White
Bianco Opaco
Bílá mat



Steel
Acciaio
Ocel



Gold 24K
Oro 24K
Zlato 24K



Matt gold 24K
Oro 24K Opaco
Zlato 24K mat



Amber-Chrome
Ambra-Cromato
Jantarová-Chrom



Orange-Chrome
Arancione-Cromato
Oranžová-Chrom



Red-Chrome
Rosso-Cromato
Červená-Chrom



Purple-Chrome
Viola-Cromato
Fialová-Chrom



Fuchsia-Chrome
Fucsia-Cromato
Fuchsiová-Chrom



Green-Chrome
Verde-Cromato
Zelená-Chrom



Black-Chrome
Nero-Cromato
Černá-Chrom



White-Chrome
Bianco-Cromato
Bílá-Chrom



Single lever washbasin mixer
Monocomando lavabo
Jednopáková umyvadlová baterie

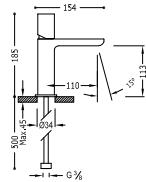

Single lever washbasin mixer
Monocomando lavabo
Jednopáková umyvadlová baterie

M	20010302NM	191,00
M	20010302BM	191,00
M	20010302AC	191,00
24	20010302OR	231,00
24	20010302OM	231,00
24	20010302AM	191,00
24	20010302NA	191,00
24	20010302RO	191,00
24	20010302VI	191,00
24	20010302FU	191,00
24	20010302VE	191,00
24	20010302NE	191,00
24	20010302BL	191,00

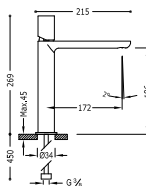

M	20020304NM	344,00
M	20020304BM	344,00
M	20020304AC	344,00
24	20020304OR	416,00
24	20020304OM	416,00
24	20020304AM	344,00
24	20020304NA	344,00
24	20020304RO	344,00
24	20020304VI	344,00
24	20020304FU	344,00
24	20020304VE	344,00
24	20020304NE	344,00
24	20020304BL	344,00



Single lever washbasin mixer

Monocomando lavabo

Jednopáková umyvadlová baterie

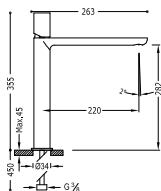

M	20020306NM	381,00
M	20020306BM	381,00
M	20020306AC	381,00
24	20020306OR	461,00
24	20020306OM	461,00
24	20020306AM	381,00
24	20020306NA	381,00
24	20020306RO	381,00
24	20020306VI	381,00
24	20020306FU	381,00
24	20020306VE	381,00
24	20020306NE	381,00
24	20020306BL	381,00

Single lever washbasin mixer

Monocomando lavabo

Jednopáková umyvadlová baterie

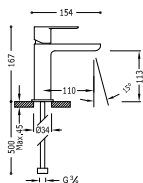

M	20010301NM	191,00
M	20010301BM	191,00
M	20010301AC	191,00
24	20010301OR	231,00
24	20010301OM	231,00
24	20010301AM	191,00
24	20010301NA	191,00
24	20010301RO	191,00
24	20010301VI	191,00
24	20010301FU	191,00
24	20010301VE	191,00
24	20010301NE	191,00
24	20010301BL	191,00

Single lever washbasin mixer

Monocomando lavabo

Jednopáková umyvadlová baterie

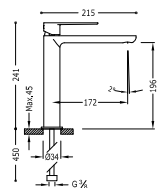

M	20020303NM	344,00
M	20020303BM	344,00
M	20020303AC	344,00
24	20020303OR	416,00
24	20020303OM	416,00
24	20020303AM	344,00
24	20020303NA	344,00
24	20020303RO	344,00
24	20020303VI	344,00
24	20020303FU	344,00
24	20020303VE	344,00
24	20020303NE	344,00
24	20020303BL	344,00

Single lever washbasin mixer

Monocomando lavabo

Jednopáková umyvadlová baterie

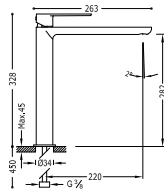

9130190

	20020305NM	381,00
	20020305BM	381,00
	20020305AC	381,00
	20020305OR	461,00
	20020305OM	461,00
	20020305AM	381,00
	20020305NA	381,00
	20020305RO	381,00
	20020305VI	381,00
	20020305FU	381,00
	20020305VE	381,00
	20020305NE	381,00
	20020305BL	381,00

Single lever washbasin mixer

with open cascade spout. NOTE: Taps with a cascade spout come with 2 regulation valves and a filter (Nr.: 9134525)

Monocomando lavabo

con bocca a cascata aperta. NOTA: La rubinetteria con canna a cascata è accompagnata da 2 rubinetti di regolazione con filtro (Ref: 9134525)

Jednopáková umyvadlová baterie

ramínko s otevřeným vodopádem. POZNÁMKA: Baterie typu vodopádu je doplněna dvěma regulačními kohouty s filtrem (Kód: 9134525)

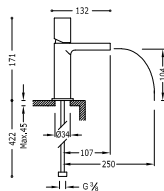

9130190

	20011002AM	320,00
	20011002NA	320,00
	20011002RO	320,00
	20011002VI	320,00
	20011002FU	320,00
	20011002VE	320,00
	20011002NE	320,00
	20011002BL	320,00

Single lever washbasin mixer

with open cascade spout. NOTE: Taps with a cascade spout come with 2 regulation valves and a filter (Nr.: 9134525)

Monocomando lavabo

con bocca a cascata aperta. NOTA: La rubinetteria con canna a cascata è accompagnata da 2 rubinetti di regolazione con filtro (Ref: 9134525)

Jednopáková umyvadlová baterie

ramínko s otevřeným vodopádem. POZNÁMKA: Baterie typu vodopádu je doplněna dvěma regulačními kohouty s filtrem (Kód: 9134525)

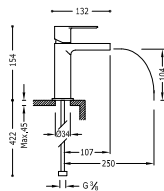

9130190

	20011001AM	320,00
	20011001NA	320,00
	20011001RO	320,00
	20011001VI	320,00
	20011001FU	320,00
	20011001VE	320,00
	20011001NE	320,00
	20011001BL	320,00





Single lever washbasin mixer
Monocomando lavabo
Jednopáková umyvadlová baterie

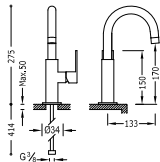

	20020504NM	272,00
	20020504BM	272,00
	20020504AC	272,00
	20020504OR	330,00
	20020504OM	330,00
	20020504AM	272,00
	20020504NA	272,00
	20020504RO	272,00
	20020504VI	272,00
	20020504FU	272,00
	20020504VE	272,00
	20020504NE	272,00
	20020504BL	272,00



Single lever washbasin mixer
Monocomando lavabo
Jednopáková umyvadlová baterie

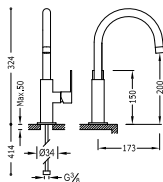

	20020505NM	282,00
	20020505BM	282,00
	20020505AC	282,00
	20020505OR	342,00
	20020505OM	342,00
	20020505AM	282,00
	20020505NA	282,00
	20020505RO	282,00
	20020505VI	282,00
	20020505FU	282,00
	20020505VE	282,00
	20020505NE	282,00
	20020505BL	282,00



Single lever washbasin mixer
Monocomando lavabo
Jednopáková umyvadlová baterie

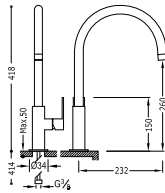

M	20020506NM	292,00
M	20020506BM	292,00
M	20020506AC	292,00
24	20020506OR	352,00
24	20020506OM	352,00
24	20020506AM	292,00
24	20020506NA	292,00
24	20020506RO	292,00
24	20020506VI	292,00
24	20020506FU	292,00
24	20020506VE	292,00
24	20020506NE	292,00
24	20020506BL	292,00

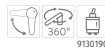

Single lever washbasin mixer
spout 35x15 mm.

Monocomando lavabo
canna 35x15 mm.

Jednopáková umyvadlová baterie
ramínko 35x15 mm

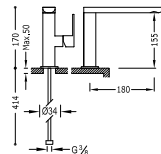

M	20020501NM	282,00
M	20020501BM	282,00
M	20020501AC	282,00
24	20020501OR	342,00
24	20020501OM	342,00
24	20020501AM	282,00
24	20020501NA	282,00
24	20020501RO	282,00
24	20020501VI	282,00
24	20020501FU	282,00
24	20020501VE	282,00
24	20020501NE	282,00
24	20020501BL	282,00



**Single lever washbasin mixer
spout 35x15 mm.**

**Monocomando lavabo
canna 35x15 mm.**

*Jednopáková umyvadlová baterie
ramínko 35x15 mm*

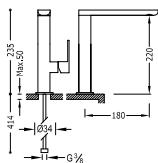

9130190

M	20020502NM	311,00
M	20020502BM	311,00
M	20020502AC	311,00
Z4	20020502OR	377,00
Z4	20020502OM	377,00
Z4	20020502AM	311,00
Z4	20020502NA	311,00
Z4	20020502RO	311,00
Z4	20020502VI	311,00
Z4	20020502FU	311,00
Z4	20020502VE	311,00
Z4	20020502NE	311,00
Z4	20020502BL	311,00

**Single lever washbasin mixer
spout 35x15 mm.**

**Monocomando lavabo
canna 35x15 mm.**

*Jednopáková umyvadlová baterie
ramínko 35x15 mm*

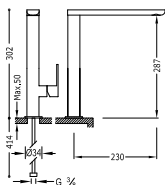

9130190

M	20020503NM	371,00
M	20020503BM	371,00
M	20020503AC	371,00
Z4	20020503OR	449,00
Z4	20020503OM	449,00
Z4	20020503AM	371,00
Z4	20020503NA	371,00
Z4	20020503RO	371,00
Z4	20020503VI	371,00
Z4	20020503FU	371,00
Z4	20020503VE	371,00
Z4	20020503NE	371,00
Z4	20020503BL	371,00

Single lever wall washbasin mixer

Indivisible concealed body with buffers. Anti-moisture seal. Short spout 180 mm.

Monomando a muro

Corpo a incasso indivisibile con smorzatori. Guarnizione antiumidità. Canna corta 180 mm.

Jednopáková nástěnná baterie

Podomítkové těleso v nedělitelném provedení s tlumiči. Těsnění proti vlhkosti. Krátké ramínko 180 mm



29902801

M	20030001NM	337,00
M	20030001BM	337,00
M	20030001AC	337,00
Z4	20030001OR	408,00
Z4	20030001OM	408,00

Single lever wall washbasin mixer

Indivisible concealed body with buffers. Anti-moisture seal. Short spout 240 mm.

Monomando a muro

Corpo a incasso indivisibile con smorzatori. Guarnizione antiumidità. Canna corta 240 mm.

Jednopáková nástěnná baterie

Podomítkové těleso v nedělitelném provedení s tlumiči. Těsnění proti vlhkosti. Krátké ramínko 240 mm



29902801

M	20030002NM	353,00
M	20030002BM	353,00
M	20030002AC	353,00
Z4	20030002OR	429,00
Z4	20030002OM	429,00

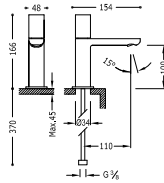

1 water or premixed bathroom tap

Rubinetto lavandino 1 acqua o premiscelata

Umyvadlová baterie pro jednu nebo předem smíchanou vodu



	20050301NM	172,00
	20050301BM	172,00
	20050301AC	172,00
	20050301OR	208,00
	20050301OM	208,00

BIDETS | BIDET | BIDEŤY

Single lever bidet mixer

Monocomando bidet

Jednopáková bidetová baterie

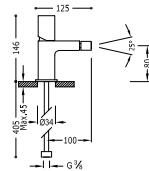

	20012002NM	195,00
	20012002BM	195,00
	20012002AC	195,00
	20012002OR	235,00
	20012002OM	235,00
	20012002AM	195,00
	20012002NA	195,00
	20012002RO	195,00
	20012002VI	195,00
	20012002FU	195,00
	20012002VE	195,00
	20012002NE	195,00
	20012002BL	195,00

Single lever bidet mixer

Monocomando bidet

Jednopáková bidetová baterie

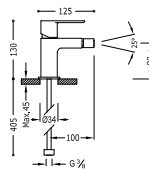

	20012001NM	195,00
	20012001BM	195,00
	20012001AC	195,00
	20012001OR	235,00
	20012001OM	235,00
	20012001AM	195,00
	20012001NA	195,00
	20012001RO	195,00
	20012001VI	195,00
	20012001FU	195,00
	20012001VE	195,00
	20012001NE	195,00
	20012001BL	195,00



Single lever bidet mixer
Monocomando bidet
Jednopáková bidetová baterie

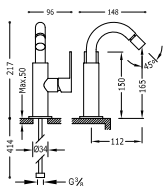

M	20022401NM	261,00
M	20022401BM	261,00
M	20022401AC	261,00
Z4	20022401OR	315,00
Z4	20022401OM	315,00
Z4	20022401AM	261,00
Z4	20022401NA	261,00
Z4	20022401RO	261,00
Z4	20022401VI	261,00
Z4	20022401FU	261,00
Z4	20022401VE	261,00
Z4	20022401NE	261,00
Z4	20022401BL	261,00



Concealed single lever bidet/toilets
Left or right support, interchangeable. Sateen hose.

Monocomando ad incasso per bidè WC
Supporto a destra o a sinistra, intercambiabile. Flesso satinato.

Jednopáková podomítková baterie pro bidet WC
Vyměnitelný držák zprava či zleva. Sprchová mosazná baterie s
omezovacím hrdlem 5 l/m. Systém proti kapání a flexi hadice SATIN

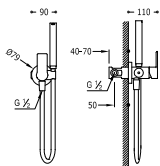

M	20522301NM	261,00
M	20522301BM	261,00
M	20522301AC	261,00

Accessory towel racks
180 mm. (for Nr.: 34123, 34122, 20522301, 20522201). NOTE: Left or right support, interchangeable.

Accessori portasciugamani
180 mm. (per ref.: 34123, 34122, 20522301, 20522201). NOTA:
Supporto a destra o a sinistra, intercambiabile.

Příslušenství držák na ručníky
180 mm. (Kód: 34123, 34122, 20522301, 20522201). POZNÁMKA: Pravý
nebo levý podstavec, vyměnitelný.



M	03412401NM	52,80
M	03412401BM	52,80
M	03412401AC	52,80



Single lever shower mixer
Anti-limescale hand shower with directable support. Shower hose SATIN.

Monocomando doccia
 Doccetta anticalcare con supporto orientabile. Flessibile satin.

Sprchová baterie
 Ruční sprcha s nastavitelným držákem, proti usaz. vod. kamene.
 Flexi hadice SATIN.

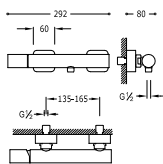

	20016701NM	340,00
	20016701BM	340,00
	20016701AC	340,00
	20016701OR	412,00
	20016701OM	412,00
	20016701AM	340,00
	20016701NA	340,00
	20016701RO	340,00
	20016701VI	340,00
	20016701FU	340,00
	20016701VE	340,00
	20016701NE	340,00
	20016701BL	340,00



Single lever bath and shower mixer
with cascade. Anti-limescale hand shower with directable support. Shower hose SATIN.

Monocomando vasca
 Con bocca a cascata. Doccetta anticalcare con supporto orientabile. Flessibile satin.

Vanová baterie
 s kaskádou. Ruční sprcha s nastavitelným držákem, proti usaz. vod. kamene. Flexi hadice SATIN.

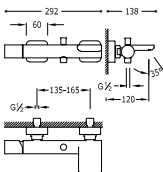

	20017001NM	395,00
	20017001BM	395,00
	20017001AC	395,00
	20017001OR	478,00
	20017001OM	478,00
	20017001AM	395,00
	20017001NA	395,00
	20017001RO	395,00
	20017001VI	395,00
	20017001FU	395,00
	20017001VE	395,00
	20017001NE	395,00
	20017001BL	395,00



Built-in mixer taps (2 way)

Built-in body included

Monocomando incasso (2 vie)

corpo incassato incluso

*Vestavěná jednopáková baterie (dvoucestrný)
včetně podomítkového tělesa*

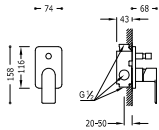

M	20018001NM	282,00
M	20018001BM	282,00
M	20018001AC	282,00
Z4	20018001OR	342,00
Z4	20018001OM	342,00
Z4	20018001AM	282,00
Z4	20018001NA	282,00
Z4	20018001RO	282,00
Z4	20018001VI	282,00
Z4	20018001FU	282,00
Z4	20018001VE	282,00
Z4	20018001NE	282,00
Z4	20018001BL	282,00

Concealed shower set

with water shut off and flow control.

- Built-in body included
- Fixed shower head 220x220 mm. with ball joint.
- Elbow wall.
- Anti-limescale hand shower.
- Shower hose SATIN.

Kit doccia ad incasso

Con chiusura e regolazione di portata.

- Corpo incassato incluso
- Doccia fissa 220x220 mm. con snodo.
- Supporto per doccia.
- Doccetta anticalcare.
- Flessibile satin.

Podomítkový jednopákový sprchový set

s uzavěrem a regulací průtoku.

- Včetně podomítkového tělesa
- Pevná sprcha 220x220 mm. s kloubem.
- Držák s nástěnným přívodem vody.
- Ruční sprcha, proti usaz. vod. kamene.
- Flexi hadice SATIN.

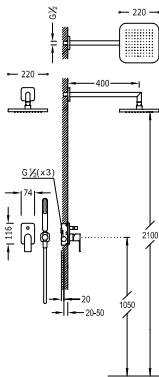

Z4	20018002AM	692,00
Z4	20018002NA	692,00
Z4	20018002RO	692,00
Z4	20018002VI	692,00
Z4	20018002FU	692,00
Z4	20018002VE	692,00
Z4	20018002NE	692,00
Z4	20018002BL	692,00

Concealed shower set

with water shut off and flow control.

- Built-in body included
- Stainless steel wall shower 160x550 mm.
- Elbow wall.
- Anti-limescale hand shower.
- Shower hose SATIN.

Kit doccia ad incasso

Con chiusura e regolazione di portata.

- Corpo incassato incluso
- Doccia acciaio inossidabile da parete 160x550 mm.
- Supporto per doccia.
- Doccetta anticalcare.
- Flessibile satin.

Podomítkový jednopákový sprchový set

s uzavěrem a regulací průtoku.

- Včetně podomítkového tělesa
- Nástěnné sprchové kropítko z nerez. oceli 160x550 mm.
- Držák s nástěnným přívodem vody.
- Ruční sprcha, proti usaz. vod. kamene.
- Flexi hadice SATIN.

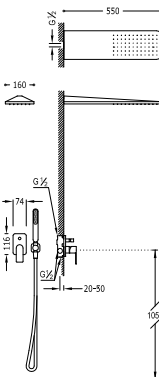

M	20018005NM	1.108,00
M	20018005BM	1.108,00
M	20018005AC	1.108,00
Z4	20018005OR	1.343,00
Z4	20018005OM	1.343,00



DECK-MOUNTED BATHTUBS | BORDOVASCA | VANY S PRODLOUŽENÝM PULTEM

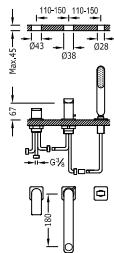

Bath-shower single lever tap for bracket shelf with shower Anti-limescale.
 • Flowrate: 3 bar – 16 l/m.
 • Spout 180 mm.

Monocomando bordo vasca con doccetta anticalcare.
 • Portata: 3 bar – 16 l/m.
 • Canna 180 mm.

Jednopáková stojánková vanová baterie
Sprcha, proti usaz. vod. kamene.
 • Průtok: 3 bar – 16 l/m
 • Ramínko 180 mm.



M	20016203NM	588,00
M	20016203BM	588,00
M	20016203AC	588,00
24	20016203OR	713,00
24	20016203OM	713,00

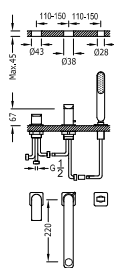

Bath-shower single lever tap for bracket shelf with shower Anti-limescale.
 • Flowrate: 3 bar – 16 l/m.
 • Spout 220 mm.

Monocomando bordo vasca con doccetta anticalcare.
 • Portata: 3 bar – 16 l/m.
 • Canna 220 mm.

Jednopáková stojánková vanová baterie
Sprcha, proti usaz. vod. kamene.
 • Průtok: 3 bar – 16 l/m
 • Ramínko 220 mm.



M	20016201NM	629,00
M	20016201BM	629,00
M	20016201AC	629,00
24	20016201OR	762,00
24	20016201OM	762,00

THERMOSTATICALLY-CONTROLLED | TERMOSTATICHE | TERMOSTATICKÉ

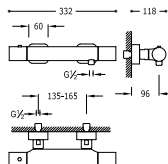

Wall thermostatic shower mixer

Anti-limescale hand shower with directable support and shower hose SATIN.

Doccia termostatica

Doccetta anticalcare con supporto orientabile. Flessibile satin.

Termostatická sprchová baterie

Ruční sprcha s nastavitelným držákem, proti usaz. vod. kamene a flexi hadice SATIN.

29919503NM	29919503RO	29919503VI	29919503AC	29919503FU	29919503OR	29919503NE	29919503AM	29919503BL
------------	------------	------------	------------	------------	------------	------------	------------	------------

M	20016409NM	442,00
M	20016409BM	442,00
M	20016409AC	442,00
24	20016409OR	536,00
24	20016409OM	536,00
24	20016409AM	442,00
24	20016409NA	442,00
24	20016409RO	442,00
24	20016409VI	442,00
24	20016409FU	442,00
24	20016409VE	442,00
24	20016409NE	442,00
24	20016409BL	442,00



Wall thermostatic shower mixer

With cascade. Anti-limescale hand shower with directable support and shower hose SATIN. Diverter integrated in the flow control.

Vasca-Doccia termostatica

Con bocca a cascata. Doccetta anticalcare con supporto orientabile. Flessibile satin. Invertitore integrato nel regolatore di portata.

Termostatická baterie pro vanu-sprchu

s kaskádou. Ruční sprcha s nastavitelným držákem, proti usaz. vod. kamene a flexi hadice SATIN. Přepínač zabudovaný v regulaci průtoku.

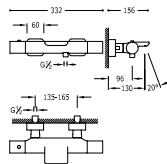

29919503NM	29919503RO
29919503BM	29919503VI
29919503AC	29919503FU
29919503OR	29919503VE
29919503OM	29919503NE
29919503AM	29919503BL
29919503AA	

M	20017409NM	556,00
M	20017409BM	556,00
M	20017409AC	556,00
Z4	20017409OR	674,00
Z4	20017409OM	674,00
Z4	20017409AM	556,00
Z4	20017409NA	556,00
Z4	20017409RO	556,00
Z4	20017409VI	556,00
Z4	20017409FU	556,00
Z4	20017409VE	556,00
Z4	20017409NE	556,00
Z4	20017409BL	556,00



Wall thermostatic shower mixer

- Fixed shower head 220x220 mm. with ball joint.
- Anti-limescale hand shower.
- Shower hose SATIN.
- Telescopic bar.
- Diverter integrated in the flow control.

Set doccia termostatica

- Doccia fissa 220x220 mm. con snodo.
- Doccetta anticalcare.
- Flessibile satin.
- Asta telescopica.
- Invertitore integrato nel regolatore di portata.

Souprava termostatické sprchové baterie

- Pevná sprcha 220x220 mm. s kloubem.
- Ruční sprcha, proti usaz. vod. kamene.
- Teleskopická tyč.
- Přepínač zabudovaný v regulaci průtoku.

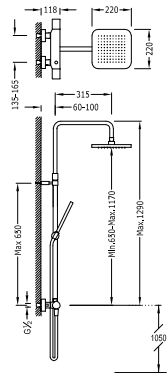

29919503AA	29919503FU
29919503NA	29919503NE
29919503RO	29919503BL
29919503VI	

Z4	20019501AM	1.085,00
Z4	20019501NA	1.085,00
Z4	20019501RO	1.085,00
Z4	20019501VI	1.085,00
Z4	20019501FU	1.085,00
Z4	20019501VE	1.085,00
Z4	20019501NE	1.085,00
Z4	20019501BL	1.085,00





Concealed thermostatic shower kit BLOCK SYSTEM
 with water shut off and flow control (2 ways).
 - Built-in thermostatic body included.
 - Stainless steel wall shower 210x550 mm.
 - Anti-limescale hand shower.
 - Shower hose SATIN.

29916401NM	29916401RO	
29916401BM	29916401VI	
29916401AC	29916401FU	
29916401OR	29916401VE	
29916401OM	29916401NE	
29916401AM	29916401BL	
29916401NA		

Kit doccia termostatica ad incasso BLOCK SYSTEM

Con chiusura e regolazione di portata (2 vie).
 - Corpo incassato termostatico incluso.
 - Doccia acciaio inossidabile da parete 210x550 mm.
 - Doccetta anticalcare.
 - Flessibile satin.

Termostatický podomítkový sprchový set BLOCK SYSTEM

s uzávěrem a regulací průtoku (2-cestná).
 - Včetně podomítkového termostatického tělesa.
 - Nástěnné sprchové křepítko z nerez. oceli 210x550 mm.
 - Ruční sprcha, proti usaz. vod. Kamene.
 - Flexi hadice SATIN.

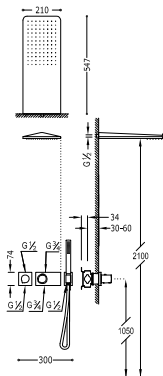

	20735202NM	1.788,00
	20735202BM	1.788,00
	20735202AC	1.788,00
	20735202OR	2.167,00
	20735202OM	2.167,00
	20735202AM	1.788,00
	20735202NA	1.788,00
	20735202RO	1.788,00
	20735202VI	1.788,00
	20735202FU	1.788,00
	20735202VE	1.788,00
	20735202NE	1.788,00
	20735202BL	1.788,00



110 / Basin mixer taps | Lavabi | Koupelňová baterie



116 / Bidets | Bidet | Bidety



117 / Bathtub mixer taps | Monocomando esterno | Jednopákový mechanismus vany



118 / Built-in sets | Monocomando ad incasso | Vestavěné soupravy



122 / Deck-mounted bathtubs | Bordovasca | Vany s prodlouženým pultem



123 / Thermostatically-controlled | Termostatica | Termostatické



124 / Block System



PROJECT-TRES



www.qtr.es/project-tres



Chrome
Cromato
Chrom



Matt Black
Nero Opaco
Černá mat



Matt White
Bianco Opaco
Bílá mat



Steel
Acciaio
Ocel



Metallic black
Nero metallizzato
Metalická černá barva



Brushed metallic black
Nero metallizzato spazzolato
Metalická černá barva kartáčovaná



Gold 24K
Oro 24K
Zlato 24K



Matt gold 24K
Oro 24K Opaco
Zlato 24K mat



Rose gold 24K
Oro rosa 24K
Růžové zlato 24K



Single lever washbasin mixer
Monocomando lavabo
Jednopáková umyvadlová baterie

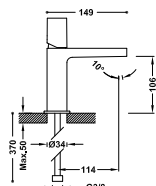

	21110302	83,35
	21110302D	98,30
	21110302NM	138,00
	21110302BM	138,00
	21110302AC	138,00
	21110302KM	138,00
	21110302KMB	138,00 N
	21110302OR	167,00
	21110302OM	167,00
	21110302OP	167,00 N

Single lever washbasin mixer
Monocomando lavabo
Jednopáková umyvadlová baterie

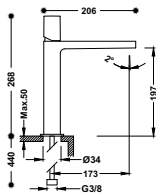

	21120302	180,00
	21120302NM	298,00
	21120302BM	298,00
	21120302AC	298,00
	21120302KM	298,00
	21120302KMB	298,00 N
	21120302OR	361,00
	21120302OM	361,00
	21120302OP	361,00 N

Single lever washbasin mixer
Monocomando lavabo
Jednopáková umyvadlová baterie

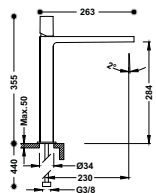

	21180302	200,00
	21180302NM	331,00
	21180302BM	331,00
	21180302AC	331,00
	21180302KM	331,00
	21180302KMB	331,00 N
	21180302OR	400,00
	21180302OM	400,00
	21180302OP	400,00 N



Single lever washbasin mixer

Monocomando lavabo

Jednopáková umyvadlová baterie

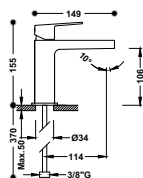

9130190

	21110301	83,35
	21110301D	98,30
	M 21110301NM	138,00
	M 21110301BM	138,00
	21110301AC	138,00
	21110301KM	138,00
	21110301KMB	138,00
	24 21110301OR	167,00
	24 21110301OM	167,00
	24 21110301OP	167,00

Single lever washbasin mixer

Monocomando lavabo

Jednopáková umyvadlová baterie

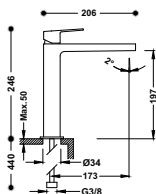

9130190

	21120301	180,00
	M 21120301NM	298,00
	M 21120301BM	298,00
	21120301AC	298,00
	21120301KM	298,00
	21120301KMB	298,00
	24 21120301OR	361,00
	24 21120301OM	361,00
	24 21120301OP	361,00

Single lever washbasin mixer

Monocomando lavabo

Jednopáková umyvadlová baterie

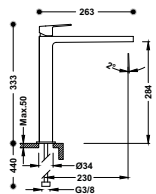

9130190

	21180301	200,00
	M 21180301NM	331,00
	M 21180301BM	331,00
	21180301AC	331,00
	21180301KM	331,00
	21180301KMB	331,00
	24 21180301OR	400,00
	24 21180301OM	400,00
	24 21180301OP	400,00

Single lever washbasin mixer

Monocomando lavabo

Jednopáková umyvadlová baterie

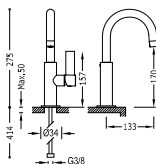

9130190

	21190401	170,00
	M 21190401NM	281,00
	M 21190401BM	281,00
	21190401AC	281,00
	21190401KM	281,00
	21190401KMB	281,00
	24 21190401OR	340,00
	24 21190401OM	340,00
	24 21190401OP	340,00

Single lever washbasin mixer

Monocomando lavabo

Jednopáková umyvadlová baterie

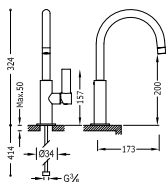

■	21190501	176,00
■ M	21190501NM	292,00
■ M	21190501BM	292,00
■	21190501AC	292,00
■	21190501KM	292,00
■	21190501KMB	292,00 N
■ 24	21190501OR	352,00
■ 24	21190501OM	352,00
■ 24	21190501OP	352,00 N

Single lever washbasin mixer

Monocomando lavabo

Jednopáková umyvadlová baterie

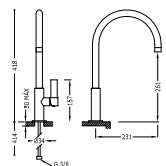

■	21190601	181,00
■ M	21190601NM	300,00
■ M	21190601BM	300,00
■	21190601AC	300,00
■	21190601KM	300,00
■	21190601KMB	300,00 N
■ 24	21190601OR	363,00
■ 24	21190601OM	363,00
■ 24	21190601OP	363,00 N

Single lever washbasin mixer

spout 34x10 mm.

Monocomando lavabo

canna 34x10 mm.

Jednopáková umyvadlová baterie
ramínko 34x10 mm.

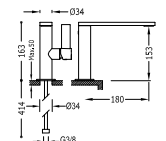

■	21120501	135,00
■ M	21120501NM	224,00
■ M	21120501BM	224,00
■	21120501AC	224,00
■	21120501KM	224,00
■	21120501KMB	224,00 N
■ 24	21120501OR	270,00
■ 24	21120501OM	270,00
■ 24	21120501OP	270,00 N

Single lever washbasin mixer

spout 34x10 mm.

Monocomando lavabo

canna 34x10 mm.

Jednopáková umyvadlová baterie
ramínko 34x10 mm.

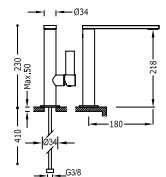

■	21130501	151,00
■ M	21130501NM	250,00
■ M	21130501BM	250,00
■	21130501AC	250,00
■	21130501KM	250,00
■	21130501KMB	250,00 N
■ 24	21130501OR	303,00
■ 24	21130501OM	303,00
■ 24	21130501OP	303,00 N



**Single lever washbasin mixer
spout 34x10 mm.**

**Monocomando lavabo
canna 34x10 mm.**

*Jednopáková umyvadlová baterie
ramínko 34x10 mm.*

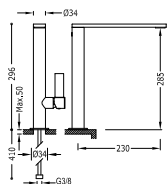

■	21140501	178,00
■ M	21140501NM	295,00
■ M	21140501BM	295,00
■	21140501AC	295,00
■	21140501KM	295,00
■	21140501KMB	295,00 N
■ 24	21140501OR	356,00
■ 24	21140501OM	356,00
■ 24	21140501OP	356,00 N

1 water or premixed bathroom tap

Rubinetto lavandino 1 acqua o premiscelata

*Umyvadlová baterie pro jednu nebo předem smíchanou
vodu*

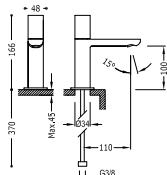

■	21150301	93,75
■ M	21150301NM	156,00
■ M	21150301BM	156,00
■	21150301AC	156,00
■	21150301KM	156,00
■	21150301KMB	156,00 N
■ 24	21150301OR	188,00
■ 24	21150301OM	188,00
■ 24	21150301OP	188,00 N



**Deck-mounted washbasin mixer tap
Free installation.**

**Monocomando lavabo a mensola
Ad installazione libera.**

*Páková baterie k umyvadlu
Možnost samostatné instalace.*

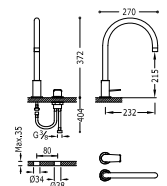

■	21110501	180,00
■ M	21110501NM	298,00
■ M	21110501BM	298,00
■	21110501AC	298,00
■	21110501KM	298,00
■	21110501KMB	298,00 N
■ 24	21110501OR	361,00
■ 24	21110501OM	361,00
■ 24	21110501OP	361,00 N



Deck-mounted washbasin mixer tap
Free installation.

Monocomando lavabo a mensola
Ad installazione libera.

Páková baterie k umyvadlu
Možnost samostatné instalace.

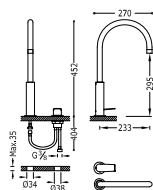

	21110502	185,00
	21110502NM	306,00
	21110502BM	306,00
	21110502AC	306,00
	21110502KM	306,00
	21110502KMB	306,00 N
	21110502OR	371,00
	21110502OM	371,00
	21110502OP	371,00 N



Counter-top dual control tap
Free installation.

Doppio comando a mensola
Ad installazione libera.

Kohoutková stojánková vanová baterie
Možnost samostatné instalace.

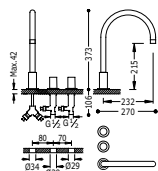

	06110501	213,00
	06110501NM	352,00
	06110501BM	352,00
	06110501AC	352,00
	06110501KM	352,00
	06110501KMB	352,00
	06110501OR	426,00
	06110501OM	426,00
	06110501OP	426,00



Counter-top dual control tap
Free installation.

Doppio comando a mensola
Ad installazione libera.

Kohoutková stojánková vanová baterie
Možnost samostatné instalace.

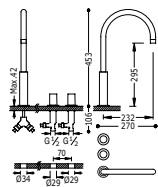

	06110502	218,00
	06110502NM	361,00
	06110502BM	361,00
	06110502AC	361,00
	06110502KM	361,00
	06110502KMB	361,00
	06110502OR	437,00
	06110502OM	437,00
	06110502OP	437,00



Single lever wall washbasin mixer

Indivisible concealed body with buffers. Anti-moisture seal. Short spout 180 mm.

Monomando a muro
Corpo a incasso indivisibile con smorzatori. Guarnizione antimidità. Canna corta 180 mm.

Jednopáková nástěnná baterie
Podomítkové těleso v nedělitelném provedení s tlumiči. Těsnění proti vlhkosti. Krátké ramínko 180 mm

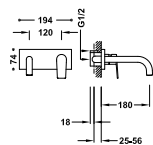

	21130011	205,00
	21130011NM	355,00
	21130011BM	355,00
	21130011AC	355,00
	21130011KM	355,00
	21130011KMB	355,00
	21130011OR	431,00
	21130011OM	431,00
	21130011OP	431,00



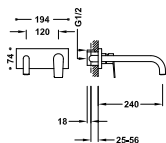

Single lever wall washbasin mixer
Indivisible concealed body with buffers. Anti-moisture seal. Short spout 240 mm.

Monomando a muro
Corpo a incasso indivisibile con smorzatori. Guarnizione antimidità. Canna corta 240 mm.

Jednopávková nástěnná baterie
Podomíthové těleso v nedělitelném provedení s tlumiči. Těsnění proti vlhkosti. Krátké ramínko 240 mm



21130012	215,00
M 21130012NM	372,00
M 21130012BM	372,00
21130012AC	372,00
21130012KM	372,00
21130012KMB	372,00
24 21130012OR	451,00
24 21130012OM	451,00
24 21130012OP	451,00

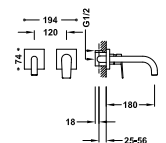

Single lever wall washbasin mixer
Indivisible concealed body with buffers. Anti-moisture seal. Short spout 180 mm.

Monomando a muro
Corpo a incasso indivisibile con smorzatori. Guarnizione antimidità. Canna corta 180 mm.

Jednopávková nástěnná baterie
Podomíthové těleso v nedělitelném provedení s tlumiči. Těsnění proti vlhkosti. Krátké ramínko 180 mm



21130001	175,00
M 21130001NM	306,00
M 21130001BM	306,00
21130001AC	306,00
21130001KM	306,00
21130001KMB	306,00
24 21130001OR	350,00
24 21130001OM	350,00
24 21130001OP	350,00

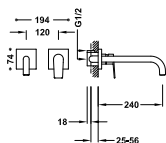

Single lever wall washbasin mixer
Indivisible concealed body with buffers. Anti-moisture seal. Short spout 240 mm.

Monomando a muro
Corpo a incasso indivisibile con smorzatori. Guarnizione antimidità. Canna corta 240 mm.

Jednopávková nástěnná baterie
Podomíthové těleso v nedělitelném provedení s tlumiči. Těsnění proti vlhkosti. Krátké ramínko 240 mm



21130002	185,00
M 21130002NM	322,00
M 21130002BM	322,00
21130002AC	322,00
21130002KM	322,00
21130002KMB	322,00
24 21130002OR	391,00
24 21130002OM	391,00
24 21130002OP	391,00

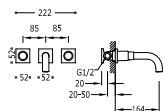

Single hole wall mixer
Built-in body is included and indivisible. Spout 164 mm.

Monoblocco a muro
Corpo incassato incluso e indivisibile. Canna 164 mm.

Nástěnná umyvadlová baterie
Včetně nerozdělitelného zabudovaného tělesa. Ramínko 164 mm.



21115101	247,00
M 21115101NM	408,00
M 21115101BM	408,00
21115101AC	408,00
21115101KM	408,00
21115101KMB	408,00
24 21115101OR	494,00
24 21115101OM	494,00
24 21115101OP	494,00

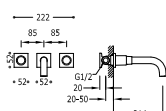

Single hole wall mixer
Built-in body is included and indivisible. Spout 214 mm.

Monoblocco a muro
Corpo incassato incluso e indivisibile. Canna 214 mm.

Nástěnná umyvadlová baterie
Včetně nerozdělitelného zabudovaného tělesa. Ramínko 214 mm.



21115201	268,00
M 21115201NM	442,00
M 21115201BM	442,00
21115201AC	442,00
21115201KM	442,00
21115201KMB	442,00
24 21115201OR	536,00
24 21115201OM	536,00
24 21115201OP	536,00

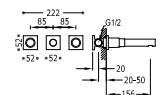

Single hole wall mixer
Built-in body is included and indivisible. Spout 156 mm.

Monoblocco a muro
Corpo incassato incluso e indivisibile. Canna 156 mm.

Nástěnná umyvadlová baterie
Včetně nerozdělitelného zabudovaného tělesa. Ramínko 156 mm.



21175101	247,00
M 21175101NM	408,00
M 21175101BM	408,00
21175101AC	408,00
21175101KM	408,00
21175101KMB	408,00
24 21175101OR	494,00
24 21175101OM	494,00
24 21175101OP	494,00

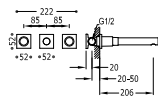

Single hole wall mixer

Built-in body is included and indivisible. Spout 206 mm.

Monoblocco a muro

Corpo incassato incluso e indivisibile. Canna 206 mm.

Nástěnná umyvadlová baterie

Včetně nerozdělitelného zabudovaného tělesa. Ramínko 206 mm.



9134/282

21175201 268,00

- 21175201NM 442,00
- M 21175201BM 442,00
- 21175201AC 442,00
- 21175201KM 442,00
- 21175201KMB 442,00 **N**
- 24 21175201OR 536,00
- 24 21175201OM 536,00
- 24 21175201OP 536,00 **N**

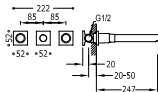

Single hole wall mixer

Built-in body is included and indivisible. Spout 247 mm.

Monoblocco a muro

Corpo incassato incluso e indivisibile. Canna 247 mm.

Nástěnná umyvadlová baterie

Včetně nerozdělitelného zabudovaného tělesa. Ramínko 247 mm.



9134/282

21175301 278,00

- 21175301NM 459,00
- M 21175301BM 459,00
- 21175301AC 459,00
- 21175301KM 459,00
- 21175301KMB 459,00 **N**
- 24 21175301OR 556,00
- 24 21175301OM 556,00
- 24 21175301OP 556,00 **N**

BIDETS | BIDET | BIDEITY

Single lever bidet mixer

Monocomando bidet

Jednopáková bidetová baterie

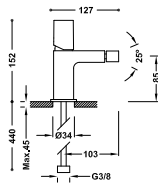

9130190

21112002 83,35

21112002D 98,30

- M 21112002NM 138,00
- M 21112002BM 138,00
- 21112002AC 138,00
- 21112002KM 138,00
- 21112002KMB 138,00 **N**
- 24 21112002OR 167,00
- 24 21112002OM 167,00
- 24 21112002OP 167,00 **N**

Single lever bidet mixer

Monocomando bidet

Jednopáková bidetová baterie

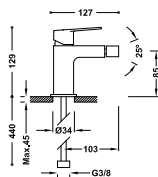

9130190

21112001 83,35

21112001D 98,30

- M 21112001NM 138,00
- M 21112001BM 138,00
- 21112001AC 138,00
- 21112001KM 138,00
- 21112001KMB 138,00 **N**
- 24 21112001OR 167,00
- 24 21112001OM 167,00
- 24 21112001OP 167,00 **N**



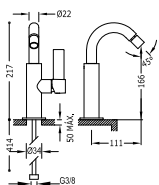

Single lever bidet mixer
Monocomando bidet
Jednopáková bidetová baterie



■	21122401	164,00
■ M	21122401NM	271,00
■ M	21122401BM	271,00
■	21122401AC	271,00
■	21122401KM	271,00
■	21122401KMB	271,00 N
■ 24	21122401OR	328,00
■ 24	21122401OM	328,00
■ 24	21122401OP	328,00 N

BATHUB MIXER TAPS | MONOCOMANDI BAGNO | JEDNOPÁKOVÝ MECHANISMUS VANY



Single lever shower mixer
Anti-limescale hand shower with directable support. Shower hose SATIN.

Monocomando doccia
Doccetta anticalcare con supporto orientabile. Flessibile satin.

Jednopáková sprchová baterie
Ruční sprcha s nastavitelným držákem, proti usaz. vod. kamene. Flexi hadice SATIN.

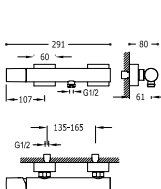

■	21116701	170,00
■ M	21116701NM	281,00
■ M	21116701BM	281,00
■	21116701AC	281,00
■	21116701KM	281,00
■	21116701KMB	281,00 N
■ 24	21116701OR	340,00
■ 24	21116701OM	340,00
■ 24	21116701OP	340,00 N

Single lever bath and shower mixer with cascade. Anti-limescale hand shower with directable support. Shower hose SATIN.

Monocomando vasca
Con bocca a cascata. Doccetta anticalcare con supporto orientabile. Flessibile satin.

Jednopáková baterie pro vanu-sprchu s kaskádou. Ruční sprcha s nastavitelným držákem, proti usaz. vod. kamene. Flexi hadice SATIN.

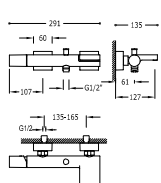

■	21117001	191,00
■ M	21117001NM	315,00
■ M	21117001BM	315,00
■	21117001AC	315,00
■	21117001KM	315,00
■	21117001KMB	315,00 N
■ 24	21117001OR	381,00
■ 24	21117001OM	381,00
■ 24	21117001OP	381,00 N

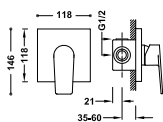

Built-in mixer taps RAPID-BOX (1 way)

Concealed body with buffers. ABS embedding box. Anti-moisture seal.

Monocomando incasso RAPID-BOX (1 via)

Corpo a incasso con smorzatori. Scatola da incasso in ABS. Guarnizione antiumidità.

Vestavěná jednopáková baterie RAPID-BOX (jednocestná)

Podomítkové těleso s tlumiči. Krabice ABS k zabudování do zdi. Těsnění proti vlhkosti.



29903507

21127701	64,90
M 21127701NM	104,00
M 21127701BM	104,00
M 21127701AC	104,00
M 21127701KM	104,00
M 21127701KMB	104,00
Z 21127701OR	130,00
Z 21127701OM	130,00
Z 21127701OP	130,00

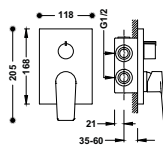

Built-in mixer taps RAPID-BOX (2 way)

Concealed body with buffers. ABS embedding box. Anti-moisture seal.

Monocomando incasso RAPID-BOX (2 vie)

Corpo a incasso con smorzatori. Scatola da incasso in ABS. Guarnizione antiumidità.

Vestavěná jednopáková baterie RAPID-BOX (dvoucestná)

Podomítkové těleso s tlumiči. Krabice ABS k zabudování do zdi. Těsnění proti vlhkosti.



29903507

21128001	109,00
M 21128001NM	175,00
M 21128001BM	175,00
M 21128001AC	175,00
M 21128001KM	175,00
M 21128001KMB	175,00
Z 21128001OR	218,00
Z 21128001OM	218,00
Z 21128001OP	218,00

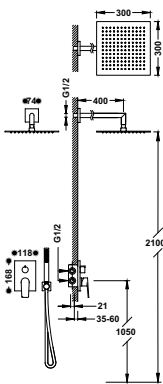

Concealed shower set RAPID-BOX

with water shut off and flow control.

- Built-in body included
- Stainless steel fixed shower head 300x300 mm. With ball joint.
- Elbow wall.
- Anti-limescale hand shower.
- Shower hose SATIN.

Kit doccia ad incasso RAPID-BOX

Con chiusura e regolazione di portata.

- Corpo incassato incluso
- Doccia fissa acciaio inossidabile 300x300 mm. con snodo.
- Supporto per doccia.
- Doccetta anticalcare.
- Flessibile satin.

Podomítkový jednopákový sprchový set RAPID-BOX

s uzávěrem a regulací průtoku.

- Včetně podomítkového tělesa
- Pevná sprcha 300x300 mm. s kloboum. Materiál nerez. oceli.
- Držák s nástěnným přívodem vody
- Ruční sprcha, proti usaz. vod. kamene.
- Flexi hadice SATIN.



29903507

21128004	464,00
M 21128004NM	765,00
M 21128004BM	765,00
M 21128004AC	765,00
M 21128004KM	765,00
M 21128004KMB	765,00
Z 21128004OR	927,00
Z 21128004OM	927,00
Z 21128004OP	927,00

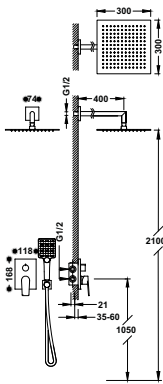

Concealed shower set RAPID-BOX

with water shut off and flow control.

- Built-in body included
- Stainless steel fixed shower head 300x300 mm. With ball joint.
- Elbow wall.
- Anti-limescale hand shower 96x110 mm. (3 jet types).
- Shower hose SATIN.

Kit doccia ad incasso RAPID-BOX

Con chiusura e regolazione di portata.

- Corpo incassato incluso
- Doccia fissa acciaio inossidabile 300x300 mm. con snodo.
- Supporto per doccia.
- Doccetta anticalcare 96x110 mm. (3 tipi di getto).
- Flessibile satin.

Podomítkový jednopákový sprchový set RAPID-BOX

s uzávěrem a regulací průtoku.

- Včetně podomítkového tělesa
- Pevná sprcha 300x300 mm. s kloboum. Materiál nerez. oceli.
- Držák s nástěnným přívodem vody
- Ruční sprcha, proti usaz. vod. kamene 96x110 mm. (3 typů proudění vody).
- Flexi hadice SATIN.



29903507

21128040	464,00
M 21128040NM	765,00
M 21128040BM	765,00
M 21128040AC	765,00
M 21128040KM	765,00
M 21128040KMB	765,00
Z 21128040OR	927,00
Z 21128040OM	927,00
Z 21128040OP	927,00



Concealed shower set RAPID-BOX

with water shut off and flow control.

- Built-in body included
- Stainless steel fixed shower head 300x300 mm. with ball joint.
- Elbow wall.
- Anti-limescale hand shower.
- Shower hose SATIN.

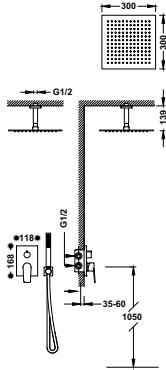

Kit doccia ad incasso RAPID-BOX

Con chiusura e regolazione di portata.

- Corpo incassato incluso
- Doccia fissa acciaio inossidabile 300x300 mm. con snodo.
- Supporto per doccia.
- Doccetta anticalcare.
- Flessibile satin.

Podomítkový jednopákový sprchový set RAPID-BOX

s uzávěrem a regulací průtoku.

- Včetně podomítkového tělesa
- Pevná sprcha 300x300 mm. s kloubem. Materiál nerez. oceli.
- Držák s nástěnným přívodem vody.
- Ruční sprcha, proti usaz. vod. kamene.
- Flexi hadice SATIN.

■	21128003	435,00
■ M	21128003NM	717,00
■ M	21128003BM	717,00
■	21128003AC	717,00
■	21128003KM	717,00
■	21128003KMB	717,00
■ 24	21128003OR	869,00
■ 24	21128003OM	869,00
■ 24	21128003OP	869,00

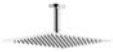

Concealed shower set RAPID-BOX

with water shut off and flow control.

- Built-in body included
- Stainless steel fixed shower head 300x300 mm. with ball joint.
- Elbow wall.
- Anti-limescale hand shower 96x110 mm. (3 jet types).
- Shower hose SATIN.

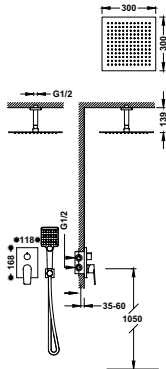

Kit doccia ad incasso RAPID-BOX

Con chiusura e regolazione di portata.

- Corpo incassato incluso
- Doccia fissa acciaio inossidabile 300x300 mm. con snodo.
- Supporto per doccia.
- Doccetta anticalcare 96x110 mm. (3 tipi di getto).
- Flessibile satin.

Podomítkový jednopákový sprchový set RAPID-BOX

s uzávěrem a regulací průtoku.

- Včetně podomítkového tělesa
- Pevná sprcha 300x300 mm. s kloubem. Materiál nerez. oceli.
- Držák s nástěnným přívodem vody.
- Ruční sprcha, proti usaz. vod. kamene 96x110 mm. (3 typů proudění vody).
- Flexi hadice SATIN.

■	21128030	435,00
■ M	21128030NM	717,00
■ M	21128030BM	717,00
■	21128030AC	717,00
■	21128030KM	717,00
■	21128030KMB	717,00
■ 24	21128030OR	869,00
■ 24	21128030OM	869,00
■ 24	21128030OP	869,00



Concealed shower set RAPID-BOX

with water shut off and flow control.

- Built-in body included
- Stainless steel wall shower 160x550 mm.
- Elbow wall.
- Anti-limescale hand shower.
- Shower hose SATIN.

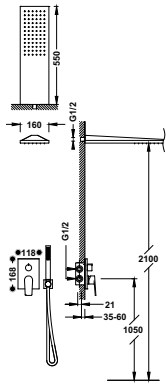

Kit doccia ad incasso RAPID-BOX

Con chiusura e regolazione di portata.

- Corpo incassato incluso
- Doccia acciaio inossidabile da parete 160x550 mm.
- Supporto per doccia.
- Doccetta anticalcare.
- Flessibile satin.

Podomítkový jednopákový sprchový set RAPID-BOX

s uzávěrem a regulací průtoku.

- Včetně podomítkového tělesa
- Nástěnné sprchové křepičko z nerez. oceli 160x550 mm.
- Držák s nástěnným přívodem vody.
- Ruční sprcha, proti usaz. vod. kamene
- Flexi hadice SATIN.

■	21128005	539,00
■ M	21128005NM	889,00
■ M	21128005BM	889,00
■	21128005AC	889,00
■	21128005KM	889,00
■	21128005KMB	889,00
■ 24	21128005OR	1077,00
■ 24	21128005OM	1077,00
■ 24	21128005OP	1077,00



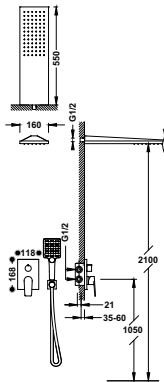

Concealed shower set RAPID-BOX

- with water shut off and flow control.
- Built-in body included
- Stainless steel wall shower 160x550 mm.
- Elbow wall.
- Anti-limescale hand shower 96x110 mm. (3 jet types).
- Shower hose SATIN.

Kit doccia ad incasso RAPID-BOX

- Con chiusura e regolazione di portata.
- Corpo incassato incluso
- Doccia acciaio inossidabile da parete 160x550 mm.
- Supporto per doccia.
- Doccetta anticalcare 96x110 mm. (3 tipi di getto).
- Flessibile satin.

Podomítkový jednopákový sprchový set RAPID-BOX

- s uzávěrem a regulací průtoku.
- Včetně podomítkového tělesa
- Nástěnné sprchové křepítko z nerez. oceli 160x550 mm.
- Držák s nástěnným přívodem vody.
- Ruční sprcha, proti usaz. vod. kamene 96x110 mm. (3 typů proudění vody).
- Flexi hadice SATIN.

■	21128050	539,00
■	21128050NM	889,00
M	21128050BM	889,00
■	21128050AC	889,00
■	21128050KM	889,00
■	21128050KMB	889,00
■	21128050OR	1.077,00
■	21128050OM	1.077,00
■	21128050OP	1.077,00



Concealed shower set RAPID-BOX

- with water shut off and flow control.
- Built-in body included
- Steel shower head Ø 380 mm.
- Elbow wall.
- Anti-limescale hand shower.
- Shower hose SATIN.

Kit doccia ad incasso RAPID-BOX

- Con chiusura e regolazione di portata.
- Corpo incassato incluso
- Soffione doccia acciaio inossidabile Ø 380 mm.
- Supporto per doccia.
- Doccetta anticalcare.
- Flessibile satin.

Podomítkový jednopákový sprchový set RAPID-BOX

- s uzávěrem a regulací průtoku.
- Včetně podomítkového tělesa
- Sprchové křepítko z nerez. oceli Ø 380 mm.
- Držák s nástěnným přívodem vody.
- Ruční sprcha, proti usaz. vod. kamene.
- Flexi hadice SATIN.

■	21128006	849,00
■	21128006NM	1.400,00
M	21128006BM	1.400,00
■	21128006AC	1.400,00
■	21128006KM	1.400,00
■	21128006KMB	1.400,00
■	21128006OR	1.697,00
■	21128006OM	1.697,00
■	21128006OP	1.697,00

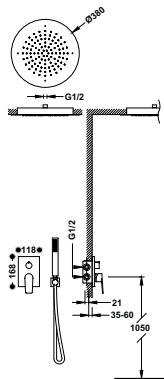

Concealed shower set RAPID-BOX

- with water shut off and flow control.
- Built-in body included
- Steel shower head Ø 380 mm.
- Elbow wall.
- Anti-limescale hand shower 96x110 mm. (3 jet types).
- Shower hose SATIN.

Kit doccia ad incasso RAPID-BOX

- Con chiusura e regolazione di portata.
- Corpo incassato incluso
- Soffione doccia acciaio inossidabile Ø 380 mm.
- Supporto per doccia.
- Doccetta anticalcare 96x110 mm. (3 tipi di getto).
- Flessibile satin.

Podomítkový jednopákový sprchový set RAPID-BOX

- s uzávěrem a regulací průtoku.
- Včetně podomítkového tělesa
- Sprchové křepítko z nerez. oceli Ø 380 mm.
- Držák s nástěnným přívodem vody.
- Ruční sprcha, proti usaz. vod. kamene 96x110 mm. (3 typů proudění vody).
- Flexi hadice SATIN.

■	21128060	849,00
■	21128060NM	1.400,00
M	21128060BM	1.400,00
■	21128060AC	1.400,00
■	21128060KM	1.400,00
■	21128060KMB	1.400,00
■	21128060OR	1.697,00
■	21128060OM	1.697,00
■	21128060OP	1.697,00

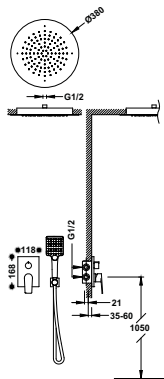

Concealed shower set RAPID-BOX

with water shut off and flow control.

- Built-in body included.
- Bath spout.
- Elbow wall.
- Anti-limescale hand shower.
- Shower hose SATIN.

Kit doccia ad incasso RAPID-BOX

Con chiusura e regolazione di portata.

- Corpo incassato incluso.
- Canna per vasca da bagno.
- Supporto per doccia.
- Doccia anticalcare.
- Flessibile satin.

Podomítkový jednopákový sprchový set RAPID-BOX

s uzávěrem a regulací průtoku.

- Včetně podomítkového tělesa.
- Kohoutek pro vanu.
- Držák s nástěnným přívodem vody.
- Ruční sprcha, proti usaz. vod. kamene.
- Flexi hadice SATIN.

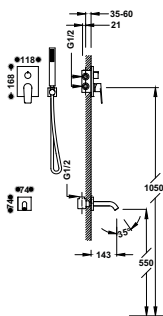

■	21128007	286,00
■	21128007NM	473,00
■	21128007BM	473,00
■	21128007AC	473,00
■	21128007KM	473,00
■	21128007KMB	473,00
■	21128007OR	573,00
■	21128007OM	573,00
■	21128007OP	573,00

Concealed shower set RAPID-BOX

with water shut off and flow control.

- Built-in body included.
- Bath spout.
- Elbow wall.
- Anti-limescale hand shower 96x110 mm. (3 jet types).
- Shower hose SATIN.

Kit doccia ad incasso RAPID-BOX

Con chiusura e regolazione di portata.

- Corpo incassato incluso.
- Canna per vasca da bagno.
- Supporto per doccia.
- Doccetta anticalcare 96x110 mm. (3 tipi di getto).
- Flessibile satin.

Podomítkový jednopákový sprchový set RAPID-BOX

s uzávěrem a regulací průtoku.

- Včetně podomítkového tělesa.
- Kohoutek pro vanu.
- Držák s nástěnným přívodem vody.
- Ruční sprcha, proti usaz. vod. Kamene 96x110 mm. (3 typů proudění vody).
- Flexi hadice SATIN.

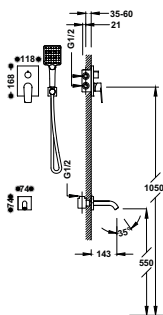

■	21128070	286,00
■	21128070NM	473,00
■	21128070BM	473,00
■	21128070AC	473,00
■	21128070KM	473,00
■	21128070KMB	473,00
■	21128070OR	573,00
■	21128070OM	573,00
■	21128070OP	573,00

DECK-MOUNTED BATHTUBS | BORDOVASCA | VANY S PRODLOUŽENÝM PULTEM

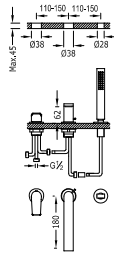

Bath-shower single lever tap for bracket shelf with shower Anti-limescale.
 • Flowrate: 3 bar – 13 l/m.
 • Compatible with tank kit ref: 20024501.
 • Spout 180 mm.

Monocomando bordo vasca con doccetta anticalcare.
 • Portata: 3 bar – 13 l/m.
 • Compatibile con il kit serbatoio cod: 20024501.
 • Canna 180 mm.

Jednopávková stojánková vanová baterie
 Sprcha, proti usaz. vod. kamene.
 • Průtok: 3 bar – 13 l/m
 • Kompatibilní se sadou nádrže ref. č.: 20024501.
 • Ramínko 180 mm.



9130190

(1)	21116101	299,00
(1)	21116101NM	493,00
(1)	21116101BM	493,00
(1)	21116101AC	493,00
(1)	21116101KM	493,00
(1)	21116101KMB	493,00 N
(1)	21116101OR	597,00
(1)	21116101OM	597,00
(1)	21116101OP	597,00 N

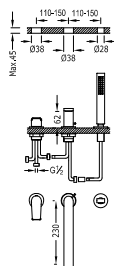

Bath-shower single lever tap for bracket shelf with shower Anti-limescale.
 • Flowrate: 3 bar – 13 l/m.
 • Compatible with tank kit ref: 20024501.
 • Spout 230 mm.

Monocomando bordo vasca con doccetta anticalcare.
 • Portata: 3 bar – 13 l/m.
 • Compatibile con il kit serbatoio cod: 20024501.
 • Canna 230 mm.

Jednopávková stojánková vanová baterie
 Sprcha, proti usaz. vod. kamene.
 • Průtok: 3 bar – 13 l/m
 • Kompatibilní se sadou nádrže ref. č.: 20024501.
 • Ramínko 230 mm.



9130190

(1)	21116103	288,00
(1)	21116103NM	476,00
(1)	21116103BM	476,00
(1)	21116103AC	476,00
(1)	21116103KM	476,00
(1)	21116103KMB	476,00 N
(1)	21116103OR	577,00
(1)	21116103OM	577,00
(1)	21116103OP	577,00 N

THERMOSTATICALLY-CONTROLLED | TERMOSTATICHE | TERMOSTATICKÉ

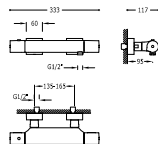

Wall thermostatic shower mixer
 Anti-limescale hand shower with directable support. Shower hose SATIN.

Doccetta termostatica
 Doccetta anticalcare con supporto orientabile. Flessibile satin.
 Termostatická sprchová baterie
 Ruční sprcha s nastavitelným držákem, proti usaz. vod. kamene.
 Flexi hadice SATIN.

29919503	29919503KMB	
29919503NM	29919503OR	
29919503BM	29919503OM	
29919503AC	29919503OP	
29919503KM		



29919503

(1)	21116409	225,00
(1)	21116409NM	371,00
(1)	21116409BM	371,00
(1)	21116409AC	371,00
(1)	21116409KM	371,00
(1)	21116409KMB	371,00 N
(1)	21116409OR	449,00
(1)	21116409OM	449,00
(1)	21116409OP	449,00 N

Wall thermostatic bath and shower mixer with cascade. Anti-limescale hand shower with directable support. Shower hose SATIN. Diverter integrated in the flow control.

29919503	29919503KMB	
29919503NM	29919503OR	
29919503BM	29919503CM	
29919503AC	29919503OP	
29919503KM		

Vasca-Doccia termostatica
Con bocca a cascata. Doccetta anticalcare con supporto orientabile. Flessibile satin. Invertitore integrato nel regolatore di portata.

Termostatická baterie pro vanu a sprchu s kaskádou. Ruční sprcha s nastavitelným držákem, proti usaz. vod. kamene. Flexi hadice SATIN. Přepínač zabudovaný v regulaci průtoku.

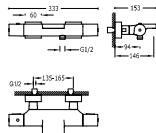

(1)	211174 09	277,00
(1)	M 211174 09NM	457,00
(1)	M 211174 09BM	457,00
(1)	211174 09AC	457,00
(1)	211174 09KM	457,00
(1)	211174 09KMB	457,00 N
(1)	24 211174 09OR	554,00
(1)	24 211174 09OM	554,00
(1)	24 211174 09OP	554,00 N



Wall thermostatic shower mixer

- Fixed shower head 300x300 mm. with ball joint.
- Anti-limescale hand shower.
- Shower hose SATIN.
- Diverter integrated in the flow control.

29919503	
29919503NM	
29919503BM	
29919503AC	

Set doccia termostatica
• Doccia fissa 300x300 mm. con snodo.
• Doccetta anticalcare.
• Flessibile satin.
• Invertitore integrato nel regolatore di portata.

Souprava termostatické sprchové baterie
• Pevná sprcha 300x300 mm. s kloubem.
• Ruční sprcha, proti usaz. vod. kamene.
• Flexi hadice SATIN.
• Přepínač zabudovaný v regulaci průtoku.

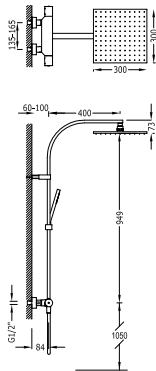

(1)	21139501	695,00
(1)	M 21139501NM	1.147,00
(1)	M 21139501BM	1.147,00
(1)	21139501AC	1.147,00



Wall thermostatic shower mixer

- Fixed shower head 300x300 mm. with ball joint.
- Anti-limescale hand shower.
- Shower hose SATIN.
- Telescopic bar.
- Diverter integrated in the flow control.

Set doccia termostatica
• Doccia fissa 300x300 mm. con snodo.
• Doccetta anticalcare.
• Flessibile satin.
• Asta telescopica.
• Invertitore integrato nel regolatore di portata.

Souprava termostatické sprchové baterie
• Pevná sprcha 300x300 mm. s kloubem.
• Ruční sprcha, proti usaz. kamene.
• Flexi hadice SATIN.
• Teleskopická tyč.
• Přepínač zabudovaný v regulaci průtoku.

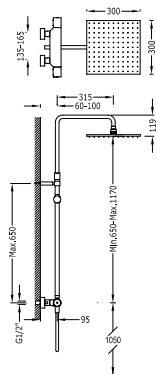

21139502	663,00
----------	--------



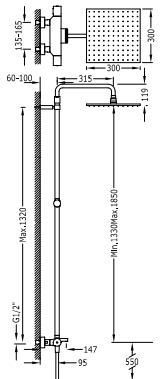

Wall thermostatic shower mixer (3 ways)

- Fixed shower head 300x300 mm. with ball joint.
- Anti-limescale hand shower.
- Shower hose SATIN.
- Telescopic bar.
- Diverter integrated in the flow control.

Vasca-Doccia termostatica (3 vie)

- Doccia fissa 300x300 mm. con snodo.
- Doccetta anticalcare.
- Flessibile satin.
- Asta telescopica.
- Invertitore integrato nel regolatore di portata.

Souprava termostatické baterie pro vanu-sprchu (3-cestná)

- Pevná sprcha 300x300 mm. s kloubem.
- Ruční sprcha, proti usaz. vod. Kamene.
- Flexi hadice SATIN.
- Teleshopická tyč.
- Přepínač zabudovaný v regulaci průtoku.

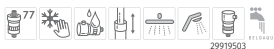

21131201

738,00

CONCEALED THERMOSTATIC MIXER | TERMOSTATICA AD INCASSO | PODOMÍTKOVÁ TERMOSTATICKÁ BATERIE



Concealed thermostatic shower kit BLOCK SYSTEM

with water shut off and flow control (2 ways).

- Built-in thermostatic body included.
- Fixed shower head Ø 300 mm. with ball joint. Brass.
- Anti-limescale hand shower.
- Shower hose SATIN.

Kit doccia termostatica ad incasso BLOCK SYSTEM

Con chiusura e regolazione di portata (2 vie).

- Corpo incassato termostatico incluso.
- Doccia fissa Ø 300 mm. con snodo. Ottone.
- Doccetta anticalcare.
- Flessibile satin.

Termostatický podomítkový sprchový set BLOCK SYSTEM

s uzávěrem a regulací průtoku (2-cestná).

- Včetně podomítkového termostatického tělesa.
- Pevná sprcha Ø 300 mm. s kloubem. Materiál Mosaz.
- Ruční sprcha, proti usaz. vod. kamene.
- Flexi hadice SATIN.

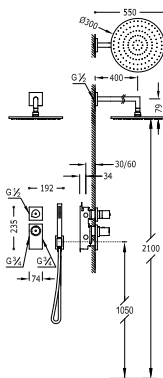

20635201

854,00

20635201NM 1.409,00

20635201BM 1.409,00

20635201AC 1.409,00

20635201KM 1.409,00



Concealed thermostatic shower kit BLOCK SYSTEM

- with water shut off and flow control (2 ways).
- Built-in thermostatic body included.
- Stainless steel wall shower 160x550 mm.
- Anti-limescale hand shower.
- Shower hose SATIN.

29916401	
29916401NM	
29916401BM	
29916401AC	

Kit doccia termostatica ad incasso BLOCK SYSTEM

- Con chiusura e regolazione di portata (2 vie).
- Corpo incassato termostatico incluso.
- Doccia acciaio inossidabile da parete 160x550 mm.
- Doccetta anticalcare.
- Flessibile satin.

Podomítkový termostatický sprchový set BLOCK SYSTEM

- s uzávěrem a regulací průtoku (2-cestná).
- Včetně podomítkového termostatického tělesa.
- Nástěnné sprchové křepitko z nerez. oceli 160x550 mm.
- Ruční sprcha, proti usaz. vod. kamene.
- Flexi hadice SATIN.

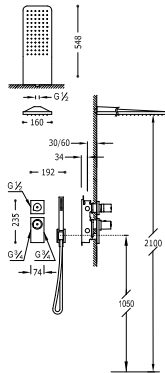

20635202 1.047,00

M 20635202NM 1.727,00

M 20635202BM 1.727,00

M 20635202AC 1.727,00



Concealed thermostatic shower kit BLOCK SYSTEM

- with water shut off and flow control (2 ways).
- Built-in thermostatic body included.
- Stainless steel ceiling shower Ø 380 mm.
- Anti-limescale hand shower.
- Shower hose SATIN.

29916401	
29916401NM	
29916401BM	
29916401AC	

Kit doccia termostatica ad incasso BLOCK SYSTEM

- Con chiusura e regolazione di portata (2 vie).
- Corpo incassato termostatico incluso.
- Soffione doccia acciaio inossidabile Ø 380 mm.
- Doccetta anticalcare.
- Flessibile satin.

Termostatický podomítkový sprchový set BLOCK SYSTEM

- s uzávěrem a regulací průtoku (2-cestná).
- Včetně podomítkového termostatického tělesa.
- Stropní sprchové křepitko z nerez. oceli Ø 380 mm.
- Ruční sprcha, proti usaz. vod. kamene.
- Flexi hadice SATIN.

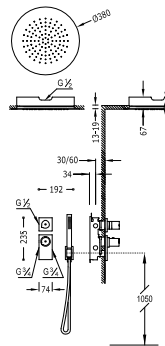

20635204 1.257,00

M 20635204NM 2.073,00

M 20635204BM 2.073,00

M 20635204AC 2.073,00



128 / Basin mixer taps | Lavabi | Koupelnová baterie



132 / Bidets | Bidet | Bidety



133 / Bathtub mixer taps | Monocomando esterno | Jednopákový mechanismus vany



137 / Built-in sets | Monocomando ad incasso | Vestavěné soupravy



139 / Monocomando vasca | Single lever bath and shower mixer | Vanová baterie



141 / Thermostatically-controlled | Termostatica | Termostatické



144 / Block System



146 / Shower Technology



TRES-CLASIC



www.qtr.es/tres-clasic



Chrome
Cromato
Chrom



Steel
Acciaio
Ocel



Gold 24K
Oro 24K
Zlato 24K



Aged brass
Ottone invecchiato
Zestárilá mosaz



Matt Aged brass
Ottone invecchiato Opaco
Zestárilá mosaz mat



Single lever washbasin mixer
 Monocomando lavabo
 Jednopáková umyvadlová baterie

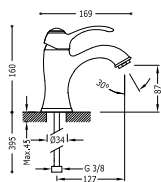

	24210301	162,00
	24210301AC	268,00
	24210301OR	323,00
	24210301LV	227,00
	24210301LM	227,00

Single lever washbasin mixer
 Monocomando lavabo
 Jednopáková umyvadlová baterie

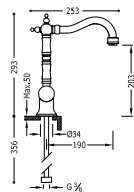

	24210801	191,00
	24210801AC	315,00
	24210801OR	381,00
	24210801LV	267,00
	24210801LM	267,00

Single hole wash-basin mixer
 Monoblocco lavabo
 Dvoupáková umyvadlová baterie

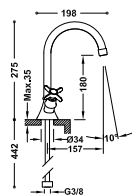

	24210901	132,00
	24210901AC	218,00
	24210901OR	264,00
	24210901LV	185,00
	24210901LM	185,00





Single hole wash-basin mixer
Monoblocco lavabo
Dvoupáková umyvadlová baterie

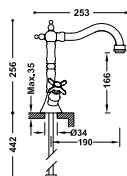

	24210902	205,00
	24210902AC	339,00
	24210902OR	410,00
	24210902LV	287,00
	24210902LM	287,00

Single hole wash-basin mixer
Monoblocco lavabo
Dvoupáková umyvadlová baterie

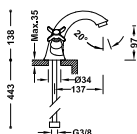

	24210201	204,00
	24210201AC	337,00
	24210201OR	408,00
	24210201LV	286,00
	24210201LM	286,00

Single hole wash-basin mixer
Free installation.
Monoblocco lavabo
Ad installazione libera.
Dvoupáková umyvadlová baterie
Možnost samostatné instalace.

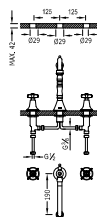

	24210501	295,00
	24210501AC	486,00
	24210501OR	589,00
	24210501LV	413,00
	24210501LM	413,00

Single hole wash-basin mixer
Free installation.
Monoblocco lavabo
Ad installazione libera.
Dvoupáková umyvadlová baterie
Možnost samostatné instalace.

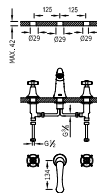

	24210601	241,00
	24210601AC	399,00
	24210601OR	482,00
	24210601LV	338,00
	24210601LM	338,00

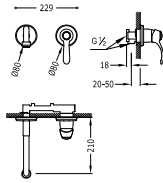

Single lever wall washbasin mixer
Built-in body is included and indivisible. Spout 210 mm.

Monoblocco a muro
Corpo incassato incluso e indivisibile. Canna 210 mm.

Jednopáková nástěnná baterie
Včetně nerozdělitelného zabudovaného tělesa. Ramínko 210 mm.



	24220001	201,00
	24220001AC	332,00
	24220001OR	402,00
	24220001LV	281,00
	24220001LM	281,00

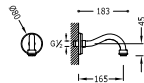

Wall spout
165 mm.

Canna parete
165 mm.

Nástěnné ramínko
165 mm.

	24217302	77,25
	24217302AC	128,00
	24217302OR	155,00
	24217302LV	108,00
	24217302LM	108,00

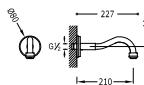

Wall spout
210 mm.

Canna parete
210 mm.

Nástěnné ramínko
210 mm.

	24217301	87,55
	24217301AC	145,00
	24217301OR	175,00
	24217301LV	123,00
	24217301LM	123,00



Single hole wall mixer
Built-in body is included and indivisible.

Monoblocco a muro
Corpo incassato incluso e indivisibile.

Nástěnná umyvadlová baterie
Včetně nerozdělitelného zabudovaného tělesa.

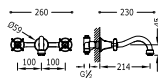

	24215101	210,00
	24215101AC	347,00
	24215101OR	420,00
	24215101LV	295,00
	24215101LM	295,00



Single hole wall mixer
Built-in body is included and indivisible.

Monoblocco a muro
Corpo incassato incluso e indivisibile.

Nástěnná umyvadlová baterie
Včetně nerozdělitelného zabudovaného tělesa.

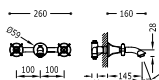

29910501

	24215102	236,00
	24215102AC	389,00
	24215102OR	472,00
	24215102LV	331,00
	24215102LM	331,00

1 water or premixed bathroom tap

Rubinetto lavandino 1 acqua o premiscelata

Umyvadlová baterie pro jednu nebo předem smíchanou vodu

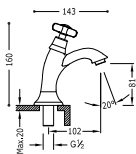

9134282

	24250301	77,25
	24250301AC	128,00
	24250301OR	155,00
	24250301LV	108,00
	24250301LM	108,00

Lateral tap

Rubinetto laterale

Baterie s bočním ovládáním

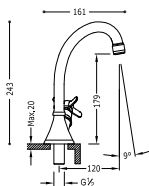

9134282

	24230601	82,40
	24230601AC	136,00
	24230601OR	165,00
	24230601LV	115,00
	24230601LM	115,00

Kitchenette tap

Rubinetto office

Kuchyňská baterie

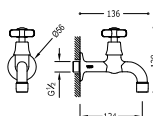

9134282

	24252001	76,25
	24252001AC	127,00
	24252001OR	152,00
	24252001LV	107,00
	24252001LM	107,00



Single lever bidet mixer
Monocomando bidet
Jednopáková bidetová baterie

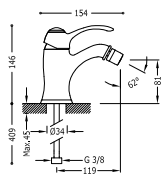

9134592

	24212001	167,00
	24212001AC	276,00
	24 24212001OR	334,00
	24212001LV	234,00
	24212001LM	234,00

Single lever bidet mixer
Monocomando bidet
Jednopáková bidetová baterie

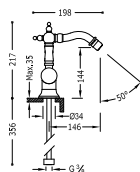

360°
9134591

	24222001	185,00
	24222001AC	306,00
	24 24222001OR	371,00
	24222001LV	260,00
	24222001LM	260,00

Single hole bidet mixer
Monoblocco bidet
Dvoupáková bidetová baterie

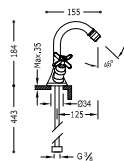

360°
9134282

	24212201	138,00
	24212201AC	229,00
	24 24212201OR	276,00
	24212201LV	194,00
	24212201LM	194,00

Single hole bidet mixer
Monoblocco bidet
Dvoupáková bidetová baterie

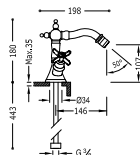

360°
9134282

	24212202	210,00
	24212202AC	347,00
	24 24212202OR	420,00
	24212202LV	295,00
	24212202LM	295,00



Single hole bidet mixer

Monoblocco bidet

Dvoupáková bidetová baterie

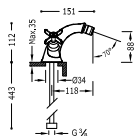

9134282

	24212101	210,00
	24212101AC	347,00
	24212101OR	420,00
	24212101LV	295,00
	24212101LM	295,00

BATHTUB MIXER TAPS | MONOCOMANDI BAGNO | JEDNOPÁKOVÝ MECHANISMUS VANY

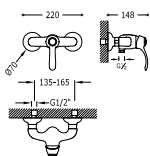

Single lever shower mixer

Anti-limescale hand shower with directable support. Double interlocked shower hose

Monocomando doccia

Doccetta anticalcare con supporto orientabile. Flessibile doppia graffatura

Jednopáková sprchová baterie

Ruční sprcha s nastavitelným držákem, proti usaz. vod. kamene.
Flexi hadice s dvojitým opletem



9134592

	24216701	224,00
	24216701AC	370,00
	24216701OR	447,00
	24216701LV	313,00
	24216701LM	313,00

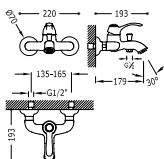

Single lever bath and shower mixer

Anti-limescale hand shower with directable support. Double interlocked shower hose

Monocomando vasca

Doccetta anticalcare con supporto orientabile. Flessibile doppia graffatura

Vanová baterie

Ruční sprcha s nastavitelným držákem, proti usaz. vod. kamene.
Flexi hadice s dvojitým opletem



9134592

	24217001	262,00
	24217001AC	433,00
	24217001OR	523,00
	24217001LV	367,00
	24217001LM	367,00

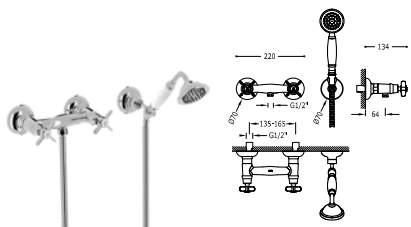

Shower mixer
Anti-limescale hand shower with directable support. Double interlocked shower hose

Gruppo doccia
Doccetta anticalcare con supporto orientabile. Flessibile doppia graffatura

Sprchový celek
Ruční sprcha s nastavitelným držákem, proti usaz. vod. kamene. Flexi hadice s dvojitým opletem



9134282

24216301 216,00

24216301AC 357,00

24 24216301OR 433,00

24216301LV 303,00

24216301LM 303,00

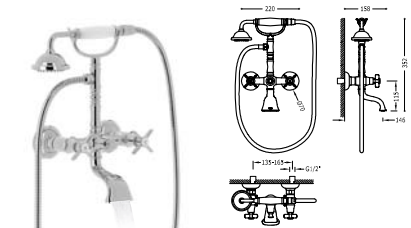

Bath and shower mixer
Anti-limescale hand shower with directable support. Double interlocked shower hose

Gruppo vasca
Doccetta anticalcare con supporto orientabile. Flessibile doppia graffatura

Sprchový celek
Ruční sprcha s nastavitelným držákem, proti usaz. vod. kamene. Flexi hadice s dvojitým opletem



9134282

24217601 323,00

24217601AC 535,00

24 24217601OR 647,00

24217601LV 453,00

24217601LM 453,00

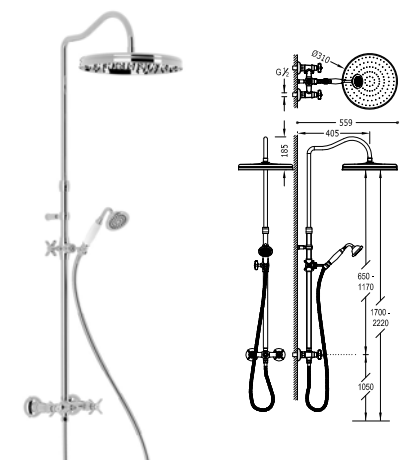

Shower mixer set
· Fixed shower head Ø 310 mm. with ball joint.
· Anti-limescale hand shower.
· Telescopic bar.
· Double interlocked shower hose.

Set monoblocco con doccia
· Doccia fissa Ø 310 mm.
· Doccetta anticalcare.
· Asta telescopica.
· Flessibile doppia graffatura.

Souprava sprchové baterie
· Pevná sprcha Ø 310 mm. s kloubem.
· Ruční sprcha, proti usaz. vod. Kamene.
· Teleskopická tyč.
· Flexi hadice s dvojitým opletem.



9134282

24219101 884,00

24219101AC 1.459,00

24 24219101LV 1.238,00

24219101LM 1.238,00

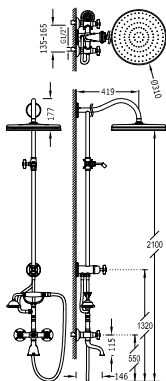

Bath and shower mixer set

- Excentric union with silencer.
- Fixed shower head Ø 310 mm. with ball joint.
- Anti-limescale hand shower.
- Double interlocked shower hose.

Set monoblocco con vasca

- Eccentrico con silenziatore.
- Doccia fissa Ø 310 mm.
- Doccetta anticalcare.
- Flessibile doppia graffatura.

Souprava sprcha-vana baterie

Excentry s tlumičem hluku.

- Pevná sprcha Ø 310 mm. s kloubem.
- Ruční sprcha, proti usaz. vod. Kamene.
- Flexi hadice s dvojitým opletem.



	24217602	600,00
	24217602AC	990,00
	24217602LV	839,00
	24217602LM	839,00

SHOWER PARTS | ELEMENTI PER DOCCIA | SPRCHOVÉ PRVKY

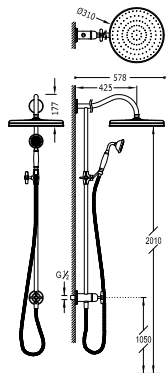

Bar-shower set

- Fixed shower head Ø 310 mm. with ball joint.
- Shower Anti-limescale.
- Double interlocked shower hose.
- With wall water intake

Set monoblocco con doccia

- Doccia fissa Ø 310 mm. con snodo.
- Doccetta anticalcare.
- Flessibile doppia graffatura.
- Con presa d'acqua a parete.

Sprchová souprava, proti usaz. vod. kamene

- Pevná sprcha Ø 310 mm. s kloubem.
- Ruční sprcha, proti usaz. vod. Kamene.
- Flexi hadice s dvojitým zámekm.
- S nástěnným přívodem vody.



	24247602	334,00
	24247602AC	551,00
	24247602LV	468,00
	24247602LM	468,00

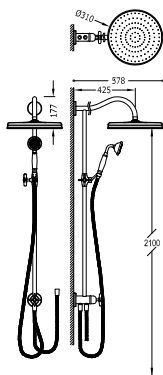

Bar-shower set





- Fixed shower head \varnothing 310 mm. with ball joint.
- Shower Anti-limescale.
- Double interlocked shower hose.
- Adaptable to a bath and shower mixer.

Set monoblocco con doccia

- Doccia fissa \varnothing 310 mm. con snodo.
- Doccetta anticalcare.
- Flessibile doppia graffatura.

Sprchová souprava, proti usaz. vod. kamene

- Pevná sprcha \varnothing 310 mm. s kloubem.
- Ruční sprcha, proti usaz. vod. kamene.
- Flexi hadice s dvojitým zámekem.
- Přizpůsobitelná na celek baterie sprchy a vany-sprchy.

	24247601	334,00
	24247601AC	551,00
	24247601LV	468,00
	24247601LM	468,00



Sliding bar

\varnothing 20,6 mm. long. 600 mm.





Asta antiscivolo

\varnothing 20,6 mm. Lungo 600 mm.

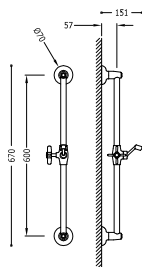
Posuvná tyč

\varnothing 20,6 mm, délka 600 mm



	24273201	165,00
	24273201AC	272,00
	24273201LV	231,00
	24273201LM	231,00

Shower holder





with wall entrance

Supporto per doccia

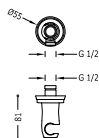
con presa a parete

Úchyt ruční sprchy se stěnovou přípojkou vody s nástěnným vodním přívodem



	24218201	52,55
	24218201AC	86,70
	24218201OR	105,00
	24218201LV	73,55
	24218201LM	73,55

Antilime shower





ceramic handle

Doccetta anticalcare

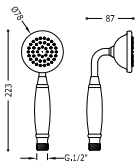
manico in ceramica

Sprcha, proti usaz. vod. kamene
keramická rukojeť



	29963109	44,30
	29963109AC	73,10
	29963109OR	88,60
	29963109LV	62,05
	29963109LM	62,05





Built-in mixer taps (1 way)
Built-in body included

Monocomando incasso (1 via)
corpo incassato incluso

*Vestavěná jednopáková baterie (jednocestný)
 včetně podomítkového tělesa*

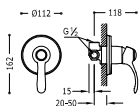

	24217701	81,40
	24217701AC	135,00
	24217701OR	163,00
	24217701LV	114,00
	24217701LM	114,00

Built-in mixer taps (2 way)
Built-in body included

Monocomando incasso (2 vie)
corpo incassato incluso

*Vestavěná jednopáková baterie (dvoucestný)
 včetně podomítkového tělesa*

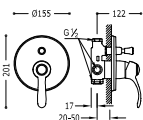

	24218001	130,00
	24218001AC	214,00
	24218001OR	260,00
	24218001LV	182,00
	24218001LM	182,00

Concealed shower kit
with water shut off and flow control.
Built-in body included

- Fixed shower head Ø 310 mm. with ball joint.
- Elbow wall.
- Shower Anti-limescale Ø 78 mm.
- Double interlocked shower hose.

Kit doccia ad incasso

Con chiusura e regolazione di portata.

- Corpo incassato incluso
- Doccia fissa Ø 310 mm. con snodo.
- Supporto per doccia.
- Doccetta anticalcare Ø 78 mm.
- Flessibile doppia graffiatura.

Sprchová sada vestavná

s uzávěrem a regulací průtoku.

- Včetně podomítkového tělesa
- Pevná sprcha Ø 310 mm. s hloubkem.
- Držák s nástěnným přívodem vody.
- Sprcha, proti usaz. vod. kamene Ø 78 mm.
- Flexi hadice s dvojitým opletem.

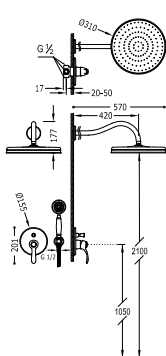

	24218003	488,00
	24218003AC	807,00
	24218003OR	976,00
	24218003LV	684,00
	24218003LM	684,00

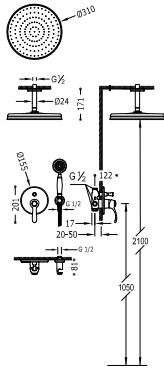

- Concealed shower kit**
 with water shut off and flow control.
 - Built-in body included
 - Fixed shower head $\varnothing 310$ mm. with ball joint.
 - Elbow wall.
 - Shower Anti-limescale $\varnothing 78$ mm.
 - Double interlocked shower hose.

- Kit doccia ad incasso**
 Con chiusura e regolazione di portata.
 - Corpo incassato incluso
 - Doccia fissa $\varnothing 310$ mm. con snodo.
 - Supporto per doccia.
 - Doccetta anticalcare $\varnothing 78$ mm.
 - Flessibile doppia graffatura.

- Sprchová sada vestavná*
 s uzávěrem a regulací průtoku.
 - Včetně podomítkového tělesa
 - Pevná sprcha $\varnothing 310$ mm. s kloubem.
 - Držák s nástěnným přívodem vody.
 - Sprcha, proti usaz. vod. kamene $\varnothing 78$ mm.
 - Flexi hadice s dvojitým opletem.

24218004 451,00

24218004AC 745,00

24218004OR 902,00

24218004LV 632,00

24218004LM 632,00



9134592

- Concealed bathtub kit**
 with water shut off and flow control.
 - Built-in body included
 - Bath spout.
 - Elbow wall.
 - Shower Anti-limescale $\varnothing 78$ mm.
 - Double interlocked shower hose.

- Kit vasca ad incasso**
 Con chiusura e regolazione di portata.
 - Corpo incassato incluso
 - Canna per vasca da bagno.
 - Supporto per doccia.
 - Doccetta anticalcare $\varnothing 78$ mm.
 - Flessibile doppia graffatura.

- Vanová sada vestavná*
 s uzávěrem a regulací průtoku.
 - Včetně podomítkového tělesa
 - Kohoutek pro vanu.
 - Držák s nástěnným přívodem vody.
 - Sprcha, proti usaz. vod. kamene $\varnothing 78$ mm.
 - Flexi hadice s dvojitým opletem.

24218005 282,00

24218005AC 467,00

24218005OR 564,00

24218005LV 396,00

24218005LM 396,00



9134592

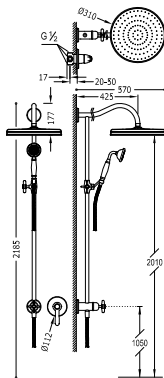

- Concealed shower kit**
 with water shut off and flow control.
 - Built-in body included
 - Fixed shower head $\varnothing 310$ mm. with ball joint.
 - Shower Anti-limescale $\varnothing 78$ mm.
 - Double interlocked shower hose.

- Kit doccia ad incasso**
 Con chiusura e regolazione di portata.
 - Corpo incassato incluso
 - Doccia fissa $\varnothing 310$ mm. con snodo.
 - Doccetta anticalcare $\varnothing 78$ mm.
 - Flessibile doppia graffatura.

- Sprchová sada vestavná*
 s uzávěrem a regulací průtoku.
 - Včetně podomítkového tělesa
 - Pevná sprcha $\varnothing 310$ mm. s kloubem.
 - Sprcha, proti usaz. vod. kamene $\varnothing 78$ mm.
 - Flexi hadice s dvojitým opletem.

24217703 374,00

24217703AC 617,00

24217703LV 524,00

24217703LM 524,00



9134592

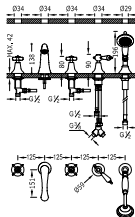

Bath-shower single lever tap for bracket shelf

Inverter.
 · Anti-limescale hand shower.

Batteria bordo vasca con invertitore.
 · Doccetta anticalcare.

Stojánková vanová baterie s přepínačem.
 · Ruční sprcha, proti usaz. kamene.

■	24214602	443,00
■	24214602AC	731,00
■	24 24214602OR	886,00
■	24214602LV	620,00
■	24214602LM	620,00



9134252

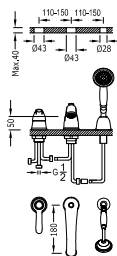

Bath-shower single lever tap for bracket shelf

Inverter.
 · Anti-limescale hand shower Ø 78 mm.
 · Flowrate: 3 bar – 16 l/m.

Monocomando bordo vasca con invertitore.
 · Doccetta anticalcare Ø 78 mm.
 · Portata: 3 bar – 16 l/m.

Jednopáková stojánková vanová baterie s přepínačem.
 · Sprcha, proti usaz. vod. kamene Ø 78 mm.
 · Průtok: 3 bar – 16 l/m

■	24214501	349,00
■	24214501AC	577,00
■	24 24214501OR	698,00
■	24214501LV	489,00
■	24214501LM	489,00



9134591

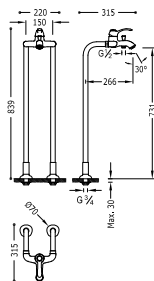

Single lever bath and shower mixer with water intake at floor. Anti-limescale hand shower. Double interlocked shower hose

Monocomando vasca con prese d'acqua a terra. Doccetta anticalcare. Flessibile doppia graffatura

Vanová baterie s vodovodní přípojkou na podlaže. Ruční sprcha proti usaz. vod. kamene. Flexi hadice s dvojitým opletem

■	24219402	498,00
■	24219402AC	821,00
■	24219402LV	697,00
■	24219402LM	697,00



9134592

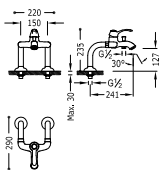

Bath-shower single lever tap for bracket shelf Anti-limescale hand shower. Double interlocked shower hose

Monocomando bordo vasca Doccetta anticalcare. Flessibile doppia graffatura

Jednopáková stojánková vanová baterie Ruční sprcha proti usaz. vod. kamene. Flexi hadice s dvojitým opletem

■	24219401	349,00
■	24219401AC	577,00
■	24 24219401OR	698,00
■	24219401LV	489,00
■	24219401LM	489,00



9134592

Wall thermostatic shower mixer
Anti-limescale hand shower with directable support. Double interlocked shower hose

- C24216401
- C24216401AC
- C24216401OR
- C24216401LV
- C24216401LM

Doccia termostatica
Doccetta anticalcare con supporto orientabile. Flessibile doppia graffatura

Termostatická sprchová baterie
Ruční sprcha s nastavitelným držákem, proti usaz. vod. kamene.
Flexi hadice s dvojitým opletem

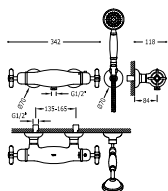

- 24216409 **379,00**
- 24216409AC **626,00**
- 24216409OR **758,00**
- 24216409LV **532,00**
- 24216409LM **532,00**



Wall thermostatic bath and shower mixer
Anti-limescale hand shower with directable support. Double interlocked shower hose. Diverter integrated in the flow control.

- C24216401
- C24216401AC
- C24216401OR
- C24216401LV
- C24216401LM

Vasca-Doccia termostatica
Doccetta anticalcare con supporto orientabile. Flessibile doppia graffatura. Invertitore integrato nel regolatore di portata.

Termostatická baterie pro vanu-sprchu
Ruční sprcha s nastavitelným držákem, proti usaz. vod. kamene.
Flexi hadice s dvojitým opletem. Přepínač zabudovaný v regulaci průtoku.

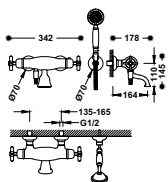

- 24217409 **424,00**
- 24217409AC **700,00**
- 24217409OR **849,00**
- 24217409LV **594,00**
- 24217409LM **594,00**



Wall thermostatic bath and shower mixer
Anti-limescale hand shower. Double interlocked shower hose. Diverter integrated in the flow control.

- C24216401
- C24216401AC
- C24216401OR
- C24216401LV
- C24216401LM

Bagno doccia termostatica
Doccetta anticalcare. Flessibile doppia graffatura. Invertitore integrato nel regolatore di portata.

Termostatická baterie pro vanu-sprchu
Ruční sprcha, proti usaz. vod. kamene a flexi hadice s dvojitým zámekem. Přepínač zabudovaný v regulaci průtoku.

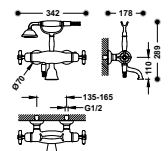

- 24217609 **491,00**
- 24217609AC **812,00**
- 24217609OR **983,00**
- 24217609LV **688,00**
- 24217609LM **688,00**



**Water intake at floor of bath
2 units**

Prese d'acqua a terra per vasca da bagno
2 unità

Vodovodní přípojky na okraj vany
2 kusy

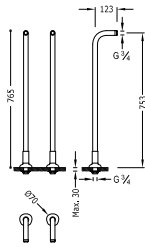

	24219403	279,00
	24219403AC	461,00
	24219403LV	391,00
	24219403LM	391,00

**Shower-bath elbow adaptor
2 units with silencer**

Gomito adattatore bagno-doccia
2 unità con silenziatore

Rohový ventil vana-sprcha
2 kusy s tlumičem

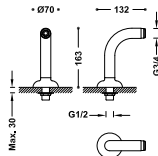

	24287101	120,00
	24287101AC	198,00
	24287101OR	239,00
	24287101LV	168,00
	24287101LM	168,00

Thermostatic bar-shower

- Sliding bar long, 600 mm.
- Shower Anti-limescale Ø 78 mm.
- Double interlocked shower hose.

Kit doccia termostatica

- Asta antiscivolo lungo 600 mm.
- Doccetta anticalcare Ø 78 mm.
- Flessibile doppia graffatura.

Sprchový set s termostatickou baterií

- Posuvná tyč o délce 600 mm.
- Sprcha, proti usaz. vod. kamene o Ø 78 mm.
- Flexi hadice s dvojitým opletem.

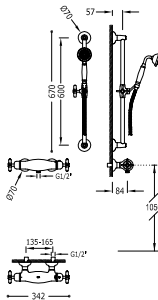

	24216402	536,00
	24216402AC	884,00
	24216402LV	750,00
	24216402LM	750,00

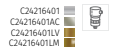

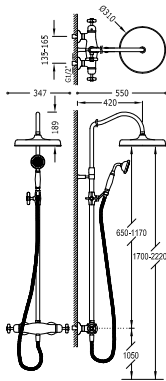

Wall thermostatic shower mixer

- Fixed shower head Ø 310 mm. with ball joint.
- Shower Anti-limescale Ø 78 mm.
- Double interlocked shower hose.
- Telescopic bar.
- Diverter integrated in the flow control.

Set doccia termostatica

- Doccia fissa Ø 310 mm. con snodo.
- Doccetta anticalcare Ø 78 mm.
- Flessibile doppia graffatura.
- Asta telescopica.
- Invertitore integrato nel regolatore di portata.

Souprava termostatické sprchové baterie

- Pevná sprcha Ø 310 mm. s kloboum.
- Sprcha, proti usaz. vod. kamene Ø 78 mm.
- Flexi hadice s dvojitým opletem.
- Teleshkopická tyč.
- Prepínač zabudovaný v regulaci průtoku.

C24216401
C24216401AC
C24216401LV
C24216401LM

■	24219502	764,00
■	24219502AC	1.262,00
■	24219502LV	1.070,00
■	24219502LM	1.070,00

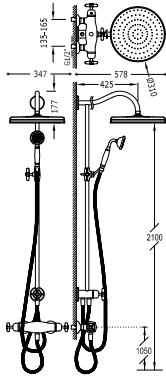

Wall thermostatic shower mixer

- Fixed shower head Ø 310 mm. with ball joint.
- Shower Anti-limescale Ø 78 mm.
- Double interlocked shower hose.

Set doccia termostatica

- Doccia fissa Ø 310 mm. con snodo.
- Doccetta anticalcare Ø 78 mm.
- Flessibile doppia graffatura.

Souprava termostatické sprchové baterie

- Pevná sprcha Ø 310 mm. s kloboum.
- Sprcha, proti usaz. vod. kamene Ø 78 mm.
- Flexi hadice s dvojitým opletem.

C24216401
C24216401AC
C24216401LV
C24216401LM

■	24219501	663,00
■	24219501AC	1.095,00
■	24219501LV	929,00
■	24219501LM	929,00

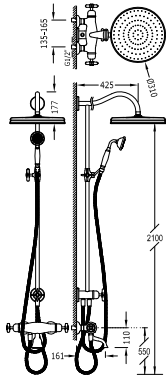

Wall thermostatic bath mixer

- Fixed shower head Ø 310 mm. with ball joint.
- Shower Anti-limescale Ø 78 mm.
- Double interlocked shower hose.
- Diverter integrated in the flow control.

Iidrodoccia termostatica

- Doccia fissa Ø 310 mm. con snodo.
- Doccetta anticalcare Ø 78 mm.
- Flessibile doppia graffatura.
- Invertitore integrato nel regolatore di portata.

Souprava termostatické baterie pro vanu-sprchu

- Pevná sprcha Ø 310 mm. s kloboum.
- Sprcha, proti usaz. vod. kamene Ø 78 mm.
- Flexi hadice s dvojitým opletem.
- Prepínač zabudovaný v regulaci průtoku.

C24216401
C24216401AC
C24216401LV
C24216401LM

■	24219801	708,00
■	24219801AC	1.168,00
■	24219801LV	991,00
■	24219801LM	991,00



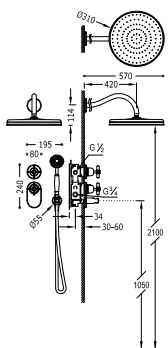

Concealed thermostatic shower kit with water shut off and flow control (2 ways).

- Built-in thermostatic body included
- Fixed shower head Ø 310 mm. with ball joint.
- Elbow wall.
- Shower Anti-limescale Ø 78 mm.
- Double interlocked shower hose.

Kit doccia termostatica ad incasso

Con chiusura e regolazione di portata (2 vie).

- Corpo incassato termostatico incluso
- Doccia fissa Ø 310 mm. con snodo.
- Supporto per doccia.
- Doccetta anticalcare Ø 78 mm.
- Flessibile doppia graffatura.

Podomítkový termostatický sprchový set

s uzávěrem a regulací průtoku (2-cestná).

- Včetně podomítkového termostatického tělesa
- Pevná sprcha Ø 310 mm. s kloboukem.
- Držák s nástěnným přívodem vody.
- Sprcha, proti usaz. vod. kamene Ø 78 mm.
- Flexi hadice s dvojitým opletem.

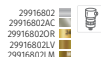

24235202	863,00
24235202AC	1.425,00
24235202OR	1.726,00
24235202LV	1.209,00
24235202LM	1.209,00

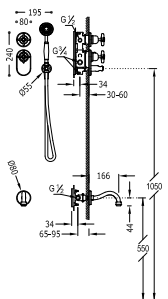

Concealed thermostatic bath kit with water shut off and flow control (2 ways).

- Built-in thermostatic body included
- Bath spout.
- Elbow wall.
- Shower Anti-limescale Ø 78 mm.
- Double interlocked shower hose.

Kit termostatico vasca ad incasso

Con chiusura e regolazione di portata (2 vie).

- Corpo incassato termostatico incluso
- Canna per vasca da bagno.
- Supporto per doccia.
- Doccetta anticalcare Ø 78 mm.
- Flessibile doppia graffatura.

Termostatický podomítkový vanový set

s uzávěrem a regulací průtoku (2-cestná).

- Včetně podomítkového termostatického tělesa
- Kojnutek pro vanu.
- Držák s nástěnným přívodem vody.
- Sprcha, proti usaz. vod. kamene Ø 78 mm.
- Flexi hadice s dvojitým opletem.



24235201	657,00
24235201AC	1.085,00
24235201OR	1.314,00
24235201LV	921,00
24235201LM	921,00



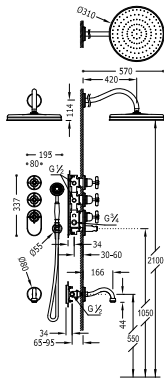

- Concealed thermostatic bath kit**
 with water shut off and flow control (3 ways).
 • Built-in thermostatic body included
 • Fixed shower head Ø 310 mm. with ball joint.
 • Bath spout.
 • Elbow wall.
 • Shower Anti-limescale Ø 78 mm.
 • Double interlocked shower hose.

- Kit termostatico vasca ad incasso**
 Con chiusura e regolazione di portata (3 vie).
 • Corpo incassato termostatico incluso
 • Doccia fissa Ø 310 mm. con snodo.
 • Canna per vasca da bagno.
 • Supporto per doccia.
 • Doccetta anticalcare Ø 78 mm.
 • Flessibile doppia graffatura.

- Termostatický podomítkový vanový set*
 s uzávěrem a regulací průtoku (3-cestná).
 • Včetně podomítkového termostatického tělesa
 • Pevná sprcha Ø 310 mm. s kloubem.
 • Kohoutek pro vanu.
 • Držák s nástěnným přívodem vody.
 • Sprcha, proti usaz. vod. kamene Ø 78 mm.
 • Flexi hadice s dvojitým opletem.



	29916802	
	29916802AC	
	29916802OR	
	29916802LV	
	29916802LM	
	24235301	1.085,00
	24235301AC	1.790,00
	24235301OR	2.169,00
	24235301LV	1.519,00
	24235301LM	1.519,00

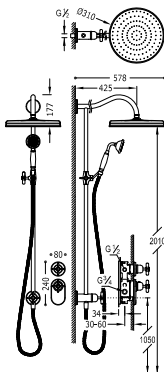

- Concealed thermostatic shower kit**
 with water shut off and flow control (1 way).
 • Built-in thermostatic body included.
 • Fixed shower head Ø 310 mm. with ball joint.
 • Shower Anti-limescale Ø 78 mm.
 • Double interlocked shower hose.

- Kit doccia termostatica ad incasso**
 Con chiusura e regolazione di portata (1 via).
 • Corpo incassato termostatico incluso
 • Doccia fissa Ø 310 mm. con snodo.
 • Doccetta anticalcare Ø 78 mm.
 • Flessibile doppia graffatura.

- Podomítkový termostatický sprchový set*
 s uzávěrem a regulací průtoku (1-cestná).
 • Včetně podomítkového termostatického tělesa
 • Pevná sprcha Ø 310 mm. s kloubem.
 • Sprcha, proti usaz. vod. kamene Ø 78 mm.
 • Flexi hadice s dvojitým opletem.



	29916802	
	29916802AC	
	29916802LV	
	29916802LM	
	24235203	792,00
	24235203AC	1.307,00
	24235203LV	1.109,00
	24235203LM	1.109,00



Built-in electronic thermostatic shower kit SHOWER TECHNOLOGY BLUE EDITION

- Electronic control included with Schlüter anti-moisture seals (White).
- Electronic thermostatic control box included (2 ways).
- Fixed shower head Ø 310 mm. with ball joint.
- Elbow wall.
- Shower Anti-limescale Ø 78 mm.
- Double interlocked shower hose.

Kit elettronico per doccia termostatico da incasso SHOWER TECHNOLOGY BLUE EDITION

- Controllo elettronico incluso con guarnizioni antiumidità Schlüter (Bianco).
- Centralina termostatica elettronica inclusa (2 vie).
- Doccia fissa Ø 310 mm. con snodo.
- Supporto per doccia.
- Doccetta anticalcare Ø 78 mm.
- Flessibile doppia graffatura.

Termostatický podomítkový elektronický sprchový set SHOWER TECHNOLOGY BLUE EDITION

- Součástí kontrolní skříňka s těsněním od firmy Schlüter (bílá barva).
- Zabudovaná termostatická elektronická kontrolní jednotka (2-cestná).
- Pevná sprcha Ø 310 mm. s kloubem.
- Držák s nástěnným přívodem vody.
- Sprcha, proti usaz. vod. kamene Ø 78 mm.
- Flexi hadice s dvojitým opletem.

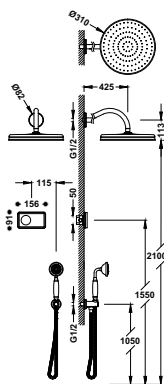

	09226201	1.041,00
	09226201AC	1.344,00
	09226201OR	1.519,00
	09226201LV	1.246,00
	09226201LM	1.246,00



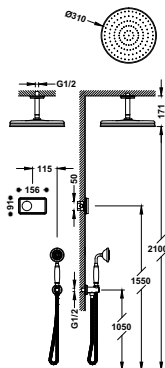

Built-in electronic thermostatic shower kit SHOWER TECHNOLOGY BLUE EDITION

- Electronic control included with Schlüter anti-moisture seals (White).
- Electronic thermostatic control box included (2 ways).
- Fixed shower head \varnothing 310 mm. with ball joint.
- Elbow wall.
- Shower Anti-limescale \varnothing 78 mm.
- Double interlocked shower hose.

Kit elettronico per doccia termostatica da incasso SHOWER TECHNOLOGY BLUE EDITION

- Controllo elettronico incluso con guarnizioni antimidità Schlüter (Bianco).
- Centralina termostatica elettronica inclusa (2 vie).
- Doccia fissa \varnothing 310 mm. con snodo.
- Supporto per doccia.
- Doccetta anticalcare \varnothing 78 mm.
- Flessibile doppia graffiatura.

Termostatický podomítkový elektronický sprchový set SHOWER TECHNOLOGY BLUE EDITION

- Součástí kontrolní skříňka s těsněním od firmy Schlüter (bílá barva).
- Zabudovaná termostatická elektronická kontrolní jednotka (2-cestná).
- Pevná sprcha \varnothing 310 mm. s kloubem.
- Držák s nástěnným přívodem vody.
- Sprcha, proti usaz. vod. kamene \varnothing 78 mm.
- Flexi hadice s dvojitým opletem.



09226202	1.017,00
09226202AC	1.302,00
24 09226202OR	1.469,00
09226202LV	1.211,00
M 09226202LM	1.211,00

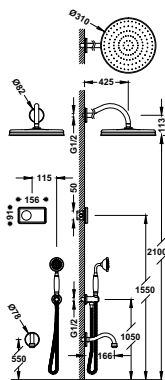

Built-in electronic thermostatic shower kit SHOWER TECHNOLOGY BLUE EDITION

- Electronic control included with Schlüter anti-moisture seals (White).
- Electronic thermostatic control box included (3 ways).
- Fixed shower head \varnothing 310 mm. with ball joint.
- Bath spout.
- Elbow wall.
- Shower Anti-limescale \varnothing 78 mm.
- Double interlocked shower hose.

Kit elettronico per doccia termostatica da incasso SHOWER TECHNOLOGY BLUE EDITION

- Controllo elettronico incluso con guarnizioni antimidità Schlüter (Bianco).
- Centralina termostatica elettronica inclusa (3 vie).
- Doccia fissa \varnothing 310 mm. con snodo.
- Canna per vasca da bagno.
- Supporto per doccia.
- Doccetta anticalcare \varnothing 78 mm.
- Flessibile doppia graffiatura.

Termostatický podomítkový elektronický sprchový set SHOWER TECHNOLOGY BLUE EDITION

- Součástí kontrolní skříňka s těsněním od firmy Schlüter (bílá barva).
- Zabudovaná termostatická elektronická kontrolní jednotka (3-cestná).
- Pevná sprcha \varnothing 310 mm. s kloubem.
- Kohoutek pro vanu.
- Držák s nástěnným přívodem vody.
- Sprcha, proti usaz. vod. kamene \varnothing 78 mm.
- Flexi hadice s dvojitým opletem.



09226301	1.154,00
09226301AC	1.503,00
24 09226301OR	1.702,00
09226301LV	1.386,00
M 09226301LM	1.386,00



**Washing machine tap
3/4"**

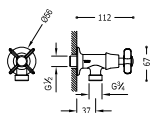

**Rubinetto lavatrice
3/4" Avvitare**

*Kohoutek pro pračku
Výstup - závit 3/4"*



9134282

	24250001	64,90
	24250001AC	107,00
	24250001OR	130,00
	24250001LV	90,85
	24250001LM	90,85

**1/2" threaded-ends gate-valve
Ceramic index (Cold)**

**Rubinetto di arresto filettato 1/2"
Indice ceramico (freddo)**

*Uzavírací ventil k zašroubování 1/2"
Keramický index (studený)*

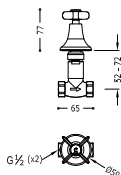

29910501

	24215501	70,05
	24215501AC	116,00
	24215501OR	140,00
	24215501LV	98,10
	24215501LM	98,10

**1/2" threaded-ends gate-valve
Ceramic index (Hot)**

**Rubinetto di arresto filettato 1/2"
Indice ceramico (caldo)**

*Uzavírací ventil k zašroubování 1/2"
Keramický index (horký)*

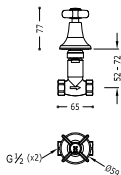

29910501

	24215502	70,05
	24215502AC	116,00
	24215502OR	140,00
	24215502LV	98,10
	24215502LM	98,10

152 / Slim-tres



153 / Cuadro-tres



155 / Max-tres / Class-tres / Project-tres



157 / Loft-tres



159 / Tres-clasic



ACCESORIES ACCESSORI VYBAVENÍ



www.qtr.es/accsoires



Chrome
Cromato
Chrom



Matt Black
Nero Opaco
Cerná mat



Matt White
Bianco Opaco
Bílá mat



Steel
Acciaio
Ocel



Gold 24K
Oro 24K
Zlato 24K







Matt gold 24K
Oro 24K Opaco
Zlato 24K mat

SLIM-TRES



Towel Bar
450 mm.
Portasciugamani
450 mm.
Držák na ručníky
450 mm.



	20223604	96,65
	M 20223604NM	160,00
	M 20223604BM	160,00
	M 20223604AC	160,00
	24 20223604OR	194,00
	24 20223604OM	194,00



Towel Bar
600 mm.
Portasciugamani
600 mm.
Držák na ručníky
600 mm.







	20223605	118,00
	M 20223605NM	196,00
	M 20223605BM	196,00
	M 20223605AC	196,00
	24 20223605OR	237,00
	24 20223605OM	237,00



Paper holder without cover
Portarotoli senza tappo
Držák na toaletní papír bez krytu



	20223612	37,10
	M 20223612NM	61,20
	M 20223612BM	61,20
	M 20223612AC	61,20
	24 20223612OR	74,20
	24 20223612OM	74,20

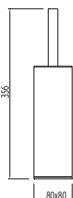

Ceramic floor-standing toilet brush
Portascopino da terra in ceramica
Stojící keramický držák na WC štětku

	20263611	125,00
---	----------	---------------

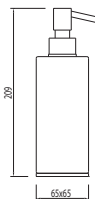

Ceramic countertop soap dispenser
Spandisapone da appoggio in ceramica
Stolní keramický dávkovač mýdla

	20263608	103,00
---	----------	---------------

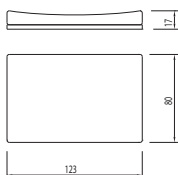

Ceramic countertop soap dish
Portasapone da appoggio in ceramica
Stolní keramická mýdelnka

	20263607	69,05
---	----------	--------------



Ceramic tumbler
Bicchieri da appoggio in ceramica
Stolní keramický kelímeček

20263609 **60,80**

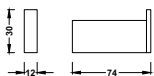

Fixed Holder
Appendino
Háček

20223613 **26,00**
 M 20223613NM **42,85**
 M 20223613BM **42,85**
 20223613AC **42,85**
 24 20223613OR **51,95**
 24 20223613OM **51,95**



CUADRO-TRES

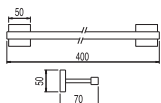

Towel Bar
400 mm.
Portasciugamani
400 mm.
Držák na ručníky
400 mm.

10723601 **64,80**
 M 10723601NM **107,00**
 M 10723601BM **107,00**
 10723601AC **107,00**
 24 10723601OR **130,00**
 24 10723601OM **130,00**

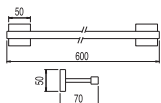

Towel Bar
600 mm.
Portasciugamani
600 mm.
Držák na ručníky
600 mm.

10723603 **75,80**
 M 10723603NM **125,00**
 M 10723603BM **125,00**
 10723603AC **125,00**
 24 10723603OR **151,00**
 24 10723603OM **151,00**

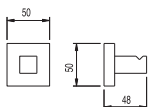

Fixed Holder
Pendino
Háček

10723620 **32,80**
 M 10723620NM **54,10**
 M 10723620BM **54,10**
 10723620AC **54,10**
 24 10723620OR **65,55**
 24 10723620OM **65,55**





Towel Bracket
Portasciugamani
Držák na ručníky

10763608

266,00



Ceramic floor-standing toilet brush
Portascopino da terra in ceramica
Stojící keramický držák na WC štětka

10763623

117,00

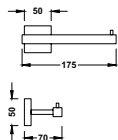

Paper holder
Portarotoli senza tappo
Držák na toaletní papír bez krytu

10723606

34,50

- 10723606NM **56,90**
- 10723606BM **56,90**
- 10723606AC **56,90**
- 10723606OR **68,95**
- 10723606OM **68,95**

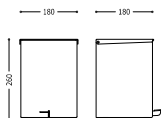

Bin
180x180x260 mm

Cestino
180x180x260 mm
Nášlapný odpadkový koš
 180x180x260 mm

10763627

155,00

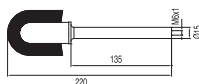

Toiletbrush
Scopetta
WC štětka
(per ref / for Nr / pro ref č: 18763623, 18763624, 1616365023, 1616365023, 1616366023, 1616366024, 16163623, 1616362353, 16163624, 5616362453, 12463604, 5246360451, 10763623)

918763690

12,40

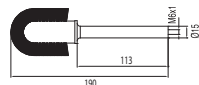

Toiletbrush
(for Nr: 20063610, 20263611, 20063611)
Scopetta
(per ref: 20063610, 20263611, 20063611)
WC štětka
(pro ref č: 20063610, 20263611, 20063611)

9120063690





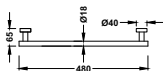

12,40

Towel Bar
480 mm.

Portasciugamani
480 mm.

Držák na ručníky
480 mm.



 16123601	60,85
 M 16123601NM	100,00
 M 16123601BM	100,00
 M 16123601AC	100,00
 24 16123601OR	122,00
 24 16123601OM	122,00

Towel Bar
580 mm.

Portasciugamani
580 mm.

Držák na ručníky
580 mm.

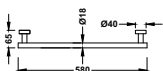

 16123602	65,75
 M 16123602NM	108,00
 M 16123602BM	108,00
 M 16123602AC	108,00
 24 16123602OR	132,00
 24 16123602OM	132,00

Towel Bar
400 mm.

Portasciugamani
400 mm.

Držák na ručníky
400 mm.

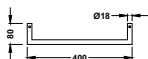





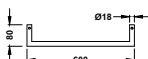

 11423601	56,65
 M 11423601NM	93,50
 M 11423601BM	93,50
 M 11423601AC	93,50
 24 11423601OR	113,00
 24 11423601OM	113,00

Towel Bar
600 mm.

Portasciugamani
600 mm.

Držák na ručníky
600 mm.



 11423602	64,90
 M 11423602NM	107,00
 M 11423602BM	107,00
 M 11423602AC	107,00
 24 11423602OR	130,00
 24 11423602OM	130,00

Double towel bar
350 mm.

Portasciugamani asta doppia
350 mm.

Držák na ručníky
s dvojitou tyčí 350 mm

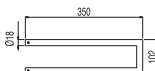

 11463610	60,80
--	--------------

Paper holder without cover
Portarotoli senza tappo

Držák na toaletní papír bez kryty

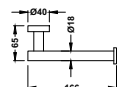



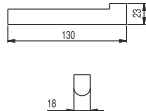



 16123606	37,10
 M 16123606NM	61,20
 M 16123606BM	61,20
 M 16123606AC	61,20
 24 16123606OR	74,20
 24 16123606OM	74,20



Paper holder without cover

Portarotoli senza tappo

Držák na toaletní papír bez krytu

	11463609	37,10
	M 11463609NM	61,20
	M 11463609BM	61,20
	M 11463609AC	61,20
	24 11463609OR	74,20
	24 11463609OM	74,20

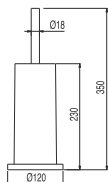

Ceramic floor-standing toilet brush

Portascopino da terra in ceramica

Stojící keramický držák na WC štětku

	16163623	95,80
---	----------	--------------

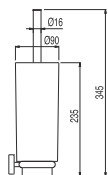

Ceramic wall-mounted toilet brush

Portascopino da parete in ceramica

Nástěnný keramický držák na WC štětku

	16163624	111,00
---	----------	---------------

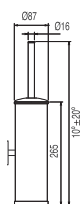

Wall-mounted toilet brush

Portascopino da parete

Nástěnný držák na WC štětku

	13463624	57,70
---	----------	--------------

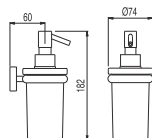

Ceramic wall-mounted soap dispenser

Spandisapone da parete in ceramica

Nástěnný keramický dávkovač mýdla

	16163618	68,00
---	----------	--------------

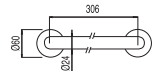

**Bathtub holder
306 mm.**

**Maniglia vasca
306 mm.**

*Vanová rukojet'
306 mm.*

	134184	25,75
---	--------	--------------

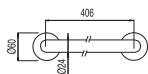

Bathtub holder

406 mm.

Maniglia vasca

406 mm.

Vanová rukojeť

406 mm.

13418440

30,90

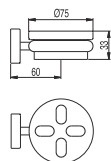

Ceramic wall-mounted toothbrush holder

Portaspazzolini da parete in ceramica

Nástěnný keramický držák na kartáč

16163616

45,35

5616361653

53,60

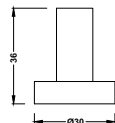

Fixed Holder

Pendino

Háček

16123620

13,40

M 16123620NM

22,10

M 16123620BM

22,10

16123620AC

22,10

24 16123620OR

26,80

24 16123620OM

26,80

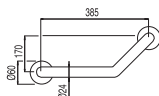

**Angular grip
with changeable soap dish**

Maniglione angolare
con portasapone intercambiabile

Zahnuté madlo
s vyměnitelnou mýdelkou

134183

61,80

LOFT-TRES

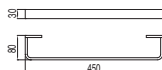

Towel Bar

450 mm.

Portasciugamani

450 mm.

Držák na ručníky

450 mm.

20023604

144,00

M 20023604NM

238,00

M 20023604BM

238,00

20023604AC

238,00

24 20023604OR

288,00

24 20023604OM

288,00



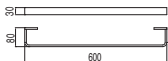





**Towel Bar
600 mm.**

Portasciugamani
600 mm.

Držák na ručníky
600 mm.



	20023605	175,00
	M 20023605NM	289,00
	M 20023605BM	289,00
	M 20023605AC	289,00
	24 20023605OR	350,00
	24 20023605OM	350,00

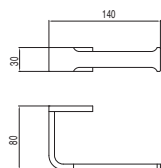







Paper holder

Portarotoli senza tappo

Držák na toaletní papír bez krytu



	20023612	52,90
	M 20023612NM	87,30
	M 20023612BM	87,30
	M 20023612AC	87,30
	24 20023612OR	106,00
	24 20023612OM	106,00

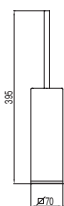

Ceramic floor-standing toilet brush

Portascopino da terra in ceramica

Stojící keramický držák na WC štetku

	20063611	128,00
---	----------	---------------

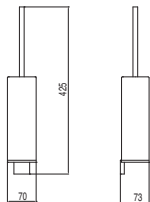

Ceramic wall-mounted toilet brush

Portascopino da parete in ceramica

Nástěnný keramický držák na WC štetku

	20063610	175,00
---	----------	---------------

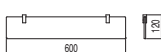

**Wall bracket
600 mm.**

Mensola cristallo trasparente
600 mm.

Průsvitná skleněná polička
600 mm.

	20063606	103,00
---	----------	---------------

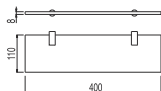

**Wall bracket
400 mm.**

Mensola cristallo trasparente
400 mm.

Průsvitná skleněná polička
400 mm.

	16163615	78,30
---	----------	--------------

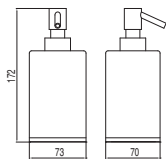

Ceramic countertop soap dispenser
 Spandisapone da appoggio in ceramica
 Stolní keramický dávkovač mýdla

20063608

101,00

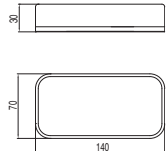

Ceramic countertop soap dish
 Portasapone da appoggio in ceramica
 Stolní keramická mýdelnka

20063607

66,95

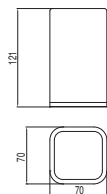

Ceramic tumbler
 Bicchieri da appoggio in ceramica
 Stolní keramický kelímek

20063609

58,75

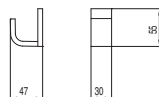

Fixed Holder
 Appendino
 Háček

20023613

30,90

M 20023613NM

51,00

M 20023613BM

51,00

20023613AC

51,00

24 20023613OR

61,80

24 20023613OM

61,80



TRES-CLASIC

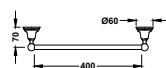

Towel Bar
 400 mm.
 Portasciugamani
 400 mm.

Držák na ručníky
 400 mm.

12423601

61,80

12423601AC

102,00

24 12423601OR

124,00

12423601LV

86,55

12423601LM

86,55



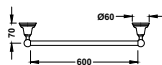

Towel Bar
600 mm.

Portasciugamani
600 mm.

Držák na ručníky
600 mm.



	12423603	64,90
	12423603AC	107,00
	24 12423603OR	130,00
	12423603LV	90,85
	12423603LM	90,85

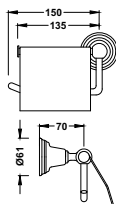

Paper holder with cover
Portarotoli con tappo

Držák na toaletní papír s krytem



	12423605	61,80
	12423605AC	102,00
	24 12423605OR	124,00
	12423605LV	86,55
	12423605LM	86,55

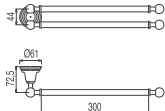

Double towel bar

Portasciugamani asta doppia

Držák na ručníky, s dvojitou tyčí

	12463608	72,10
	02463608AC	120,00
	24 02463608OR	144,00
	5246360851	99,95
	02463608LM	101,00

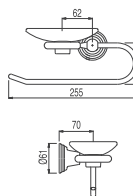

Combo open ring Holder with soapdish

Portasciugamani ad anello aperta a sinistra con portasapone

Držák na ručník zleva otevřený s mýdlenkou

	12463611	87,55
	02463611AC	145,00
	24 02463611OR	175,00
	5246361151	112,00
	02463611LM	123,00

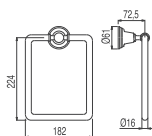

Square Towel Holder

Portasciugamani ad anello quadrato

Čtverhranný držák na ručník

	12463609	58,75
	02463609AC	96,90
	24 02463609OR	117,00
	5246360951	79,35
	02463609LM	82,20

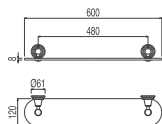

Wall bracket

Mensola cristallo trasparente

Průsvitná skleněná polička

	12463615	99,95
	02463615AC	166,00
	24 02463615OR	200,00
	5246361551	120,00
	02463615LM	140,00

Paper holder without cover

Portarotoli senza tappo

Držák na toaletní papír bez krytu

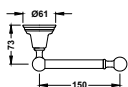

■ 12423606 **44,30**

■ 12423606AC **73,10**

■ 24 12423606OR **88,60**

■ 12423606LV **62,05**

■ M 12423606LM **62,05**



Ceramic wall-mounted tumbler holder

Portabicchiere da parete in ceramica

Nástěnný keramický držák na kelímek

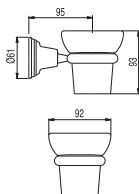

■ 12463612 **56,65**

■ 02463612AC **93,50**

■ 24 02463612OR **113,00**

■ 5246361251 **66,95**

■ M 02463612LM **79,35**

Ceramic countertop tumbler holder-soap dish

Portabicchiere-Portasapone da appoggio in ceramica

Stolní keramický držák na kelímek a mýdlo

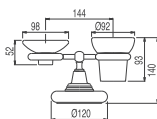

■ 12463613 **108,00**

■ 02463613AC **179,00**

■ 24 02463613OR **216,00**

■ 5246361351 **130,00**

■ M 02463613LM **151,00**

Ceramic floor-standing toilet brush

Portascopino da terra in ceramica

Stojící keramický držák na WC štětku

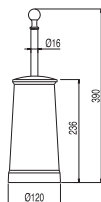

■ 12463604 **83,45**

■ 02463604AC **138,00**

■ 24 02463604OR **167,00**

■ 5246360451 **93,75**

■ M 02463604LM **117,00**

Ceramic wall-mounted soap dish

Portasapone da parete in ceramica

Nástěnná keramická mýdlenka

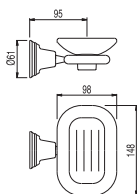

■ 12463610 **56,65**

■ 02463610AC **93,50**

■ 24 02463610OR **113,00**

■ 5246361051 **66,95**

■ M 02463610LM **79,35**

Fixed Holder

Appendino

Háček



■ 12423607 **10,30**

■ 12423607AC **17,00**

■ 24 12423607OR **20,60**

■ 12423607LV **14,45**

■ M 12423607LM **14,45**



164 / **Valve for basin** | Valvola lavabo | Umyvadlový ventil



165 / **Bath drain** | Scarico vasca | Vanový sifon



166 / **Siphon** | Sifone | Sifon



167 / **Spout** | Erogatore Vasca | Výtoková hubice



167 / **Other** | Altri | Ostatní



COMPLEMENTS
COMPLEMENTI
PŘÍSLUŠENSTVÍ



www.qtr.es/complements



Chrome
Cromato
Chrom



Matt Black
Nero Opaco
Černá mat



Matt White
Bianco Opaco
Bílá mat



Steel
Acciaio
Ocel



Metallic black
Nero metallizzato
Metalická černá barva



Brushed metallic black
Nero metallizzato spazzolato
Metalická černá barva kartáčovaná



Gold 24K
Oro 24K
Zlato 24K



Matt gold 24K
Oro 24K Opaco
Zlato 24K mat



Rose gold 24K
Oro rosa 24K
Růžové zlato 24K



Aged brass
Ottone invecchiato
Zestárilá mosaz



Matt Aged brass
Ottone invecchiato Opaco
Zestárilá mosaz mat



Amber
Ambra
Jantarová



Orange
Arancione
Oranžová



Red
Rosso
Červená



Purple
Viola
Fialová



Fuchsia
Fucsia
Fuchsiová



Green
Verde
Zelená



Black
Nero
Černá



White
Bianco
Bílá









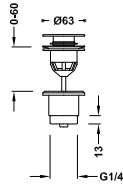









VALVE FOR BASIN | VALVOLA LAVABO | UMYVADLOVÝ VENTIL

Valve for basin
Ø 63 mm CLICK-CLACK

Valvola lavabo
Ø 63 mm CLICK-CLACK

Umyvadlový ventil
zátka Ø 63 mm CLICK-CLACK











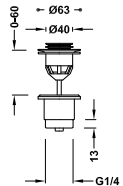



	24284001	37,95
	24284001NM	62,60
	24284001BM	62,60
	24284001AC	62,60
	24284001KM	62,60
	24284001KMB	62,60 N
	24284001OR	75,85
	24284001OM	75,85
	24284001OP	75,85 N
	24284001LV	53,10
	24284001LM	53,10
	24284001AM	62,60
	24284001NA	62,60
	24284001RO	62,60
	24284001VI	62,60
	24284001FU	62,60
	24284001VE	62,60
	24284001NE	62,60
	24284001BL	62,60

Valve for basin
Ø 40 mm CLICK-CLACK

Valvola lavabo
Ø 40 mm CLICK-CLACK

Umyvadlový ventil
zátka Ø 40 mm CLICK-CLACK



	24284002	35,30
	24284002NM	58,25
	24284002BM	58,25
	24284002AC	58,25
	24284002KM	58,25
	24284002OR	70,60
	24284002OM	70,60
	24284002LV	49,40
	24284002LM	49,40
	24284002NE	58,25
	24284002BL	58,25

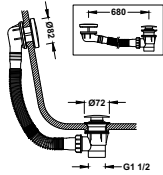

Bath drain with overflow and pop-up waste
Ø 72 mm CLICK-CLACK

Scarico vasca con troppio pieno e valvola
Ø 72 mm CLICK-CLACK

Vanový sifon s lankem pro řízení odtoku, ozdobné
metalové viditelné prvky
Ø 72 mm CLICK-CLACK

■	13453420	23,50
■	03453420AC	38,80
■ 24	03453420OR	47,00
■ 24	03453420OM	47,00
■	03453420LV	32,95
■ M	03453420LM	32,95

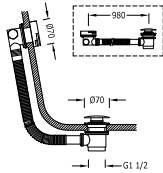

Bath drain and round CASCADE filling valve with overflow drain
Ø 70 mm CLICK-CLACK

Scarico vasca e valvola di riempimento rotonda A
CASCATA con troppio pieno
Ø 70 mm CLICK-CLACK

Odtoková a napouštěcí vanová kulatá souprava KASKÁDA
s přepadem
zátka Ø 70 mm CLICK-CLACK



Overflow drain
Troppio pieno
Přepad

Cascade
Cascata
Vodopád

■	13453430	53,80
■	03453430AC	88,75
■ 24	03453430OR	108,00
■ 24	03453430OM	108,00
■	03453430LV	75,30
■ M	03453430LM	75,30

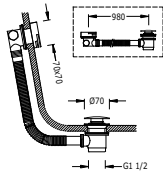

Bath drain and square CASCADE filling valve with overflow drain
Ø 70 mm CLICK-CLACK

Scarico vasca e valvola di riempimento quadrata A
CASCATA con troppio pieno
Ø 70 mm CLICK-CLACK

Odtoková a napouštěcí vanová hranatá souprava KASKÁDA
s přepadem
zátka Ø 70 mm CLICK-CLACK



Overflow drain
Troppio pieno
Přepad

Cascade
Cascata
Vodopád

■	13453440	71,80
■	03453440AC	120,00
■ 24	03453440OR	144,00
■ 24	03453440OM	144,00

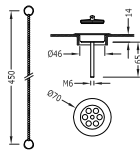

Bidet and sink accessories Ø 70 mm
Chain of 42 cm.

Set accessori per lavabo, bidé e lavello Ø 70 mm
catena da 42 cm.

Souprava příslušenství pro umyvadlo, bidetovou a
dřezovou baterii Ø 70 mm
řetěz 420 mm

■	03474601	24,75
■	03474601AC	40,80
■ 24	03474601OR	49,45
■ 24	03474601OM	49,45
■	9134746051	34,65
■ M	03474601LM	34,65

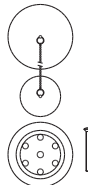

Accessories for bath Ø 70 mm
Chain of 42 cm.

Set accessori per vasca Ø 70 mm
catena da 42 cm.

Souprava příslušenství pro vanovou baterii Ø 70 mm
řetěz 420 mm

■	03474501	30,90
■	03474501AC	51,00
■ 24	03474501OR	61,80
■ 24	03474501OM	61,80
■	9134745051	43,30
■ M	03474501LM	43,30

Telescopic visible basin drain trap WITH SKIRT

Sifone telescopico a vista per lavabo CON PANNELLO

Umyvadlový viditelný sifon, čtverhranný, výsuvný, s krytem

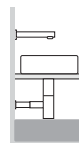
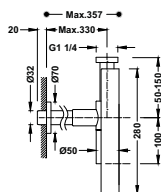









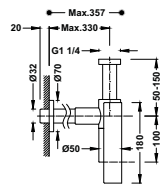

	10710342	181,00
	10710342NM	300,00
	10710342BM	300,00
	10710342AC	300,00
	10710342OR	363,00
	10710342OM	363,00

Telescopic visible basin drain trap WITH SKIRT

Sifone telescopico a vista per lavabo CON PANNELLO

Výsuvný umyvadlový viditelný sifon s krytem









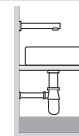
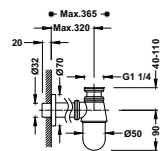

	16110342	156,00
	16110342NM	258,00
	16110342BM	258,00
	16110342AC	258,00
	16110342KM	258,00 N
	16110342KMB	258,00 N
	16110342OR	311,00
	16110342OM	311,00
	16110342OP	311,00 N
	561103451	224,00

Self-inspecting bottle-type drain trap for basin

Sifone a bottiglia facilmente ispezionabile per lavabo

Umyvadlový lahvový sifon, rozšroubovatelný



	13463430	22,95
	03463430NM	37,90
	03463430BM	37,90
	03463430AC	37,90
	03463430OR	45,85
	03463430OM	45,85
	03463430LV	32,10
	03463430LM	32,10

Curved, articulated drain trap for basin

Sifone curvo articolato per lavabo

Umyvadlový sifon s kloubovým zakřivením. S otvorem

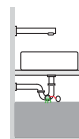
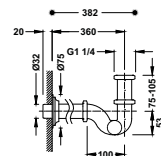

	13463820	24,70
	03463820AC	40,75
	03463820OR	49,35
	03463820OM	49,35
	03463820LV	34,60
	03463820LM	34,60

SPOUT | EROGATORE VASCA | VÝTOKOVÁ HUBICE

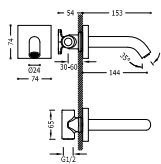

Wall spout
Canna parete
Nástěnné ramínko

	M 21018107NM	162,00
	M 21018107BM	162,00
	M 21018107AC	162,00
	M 21018107KM	162,00
	M 21018107KMB	162,00
	N 21018107OR	196,00
	N 21018107OM	196,00
	N 21018107OP	196,00

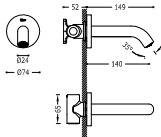

Wall spout
Canna parete
Nástěnné ramínko

	M 26218004NM	162,00
	M 26218004BM	162,00
	M 26218004AC	162,00
	M 26218004KM	162,00
	M 26218004KMB	162,00
	N 26218004OR	196,00
	N 26218004OM	196,00
	N 26218004OP	196,00

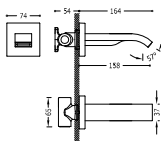

Cascade cast spout
Erogatore a cascata
Ramínko s vodopádem

	M 20718107NM	398,00
	M 20718107BM	398,00
	M 20718107AC	398,00
	N 20718107OR	482,00
	N 20718107OM	482,00

OTHER | ALTRI | OSTATNÍ

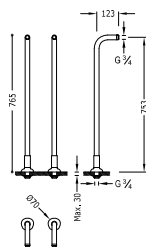

Water intake at floor of bath
2 units
Prese d'acqua a terra per vasca da bagno
2 unità
Vodovodní přípojky na okraj vany
2 kusy

	M 24219403	279,00
	M 24219403AC	461,00
	M 24219403LV	391,00
	M 24219403LM	391,00

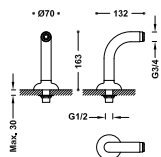

Shower-bath elbow adaptor
2 units with silencer
Gomito adattatore bagno-doccia
2 unità con silenziatore
Rohový ventil vana-sprcha
2 kusy s tlumičem

	M 24287101	120,00
	M 24287101AC	198,00
	N 24287101OR	239,00
	N 24287101LV	168,00
	N 24287101LM	168,00

170 / **Kitchen mixer taps** | Cucina monocomando | Dřezové baterie s jednopákovým mechanismem



176 / **Flexible kitchen tap** | Cucina con getto flessibile | Dřezová baterie s pružným ramenem



177 / **Removable kitchen tap** | Cucina con getto flessibile estraibile | Dřezová baterie s výsuvnou sprškou



179 / **Folding kitchen taps** | Cucina reclinabile | Dřezová baterie sklopná



180 / **Electronic kitchen taps** | Cucina elettronica | Dřezové elektronické baterie



181 / **Dual-control kitchen taps** | Cucina doppio comando | Dřezové baterie s dvoupákovým mechanismem



KITCHEN CUCINA KUCHYNĚ



www.qtr.es/kitchen



Chrome
Cromato
Chrom



Matt Black
Nero Opaco
Cerná mat



Matt White
Bianco Opaco
Bílá mat



Steel
Acciaio
Ocel



Gold 24K
Oro 24K
Zlato 24K



Matt gold 24K
Oro 24K Opaco
Zlato 24K mat



Aged brass
Ottone invecchiato
Zestárilá mosaz



Matt Aged brass
Ottone invecchiato Opaco
Zestárilá mosaz mat



Amber-Chrome
Ambra-Cromato
Jantarová-Chrom



Orange-Chrome
Arancione-Cromato
Oranžová-Chrom



Red-Chrome
Rosso-Cromato
Červená-Chrom



Purple-Chrome
Viola-Cromato
Fialová-Chrom



Fuchsia-Chrome
Fucsia-Cromato
Fuchsiová-Chrom



Green-Chrome
Verde-Cromato
Zelená-Chrom



Black-Chrome
Nero-Cromato
Cerná-Chrom



White-Chrome
Bianco-Cromato
Bílá-Chrom

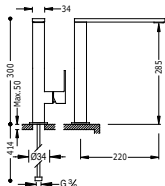

**Single lever single hole sink mixer
spout 34x10 mm**

Monocomando lavello verticale
canna 34x10 mm.

Jednopáková dřezová kuchyňská baterie
ramínko 34x10 mm

	106486	320,00
	006486NM	529,00
	006486BM	529,00
	50648603	529,00
	006486OM	641,00
	006486AM	529,00
	006486NA	529,00
	006486RO	529,00
	006486VI	529,00
	006486FU	529,00
	006486VE	529,00
	606486	529,00
	406486	529,00

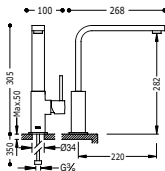

**Single lever single hole sink mixer
Tube spout 35x15 mm.**

Monocomando lavello verticale
Canna tubo 35x15 mm.

Jednopáková dřezová kuchyňská baterie
ramínko 35x15 mm

	130496	233,00
	030496NM	384,00
	030496BM	384,00
	53049603	384,00
	030496OM	466,00

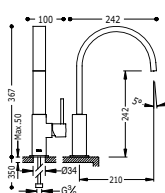

**Single lever single hole sink mixer
Tube spout 35x15 mm. Rectangular Aerator**

Monocomando lavello verticale
Canna tubo 35x15 mm. Aeratore rettangolare

Jednopáková dřezová kuchyňská baterie
ramínko 35x15 mm se skrytým obdélníkovým perlátorem

	130498	246,00
	030498NM	407,00
	030498BM	407,00
	53049803	407,00
	030498OM	492,00



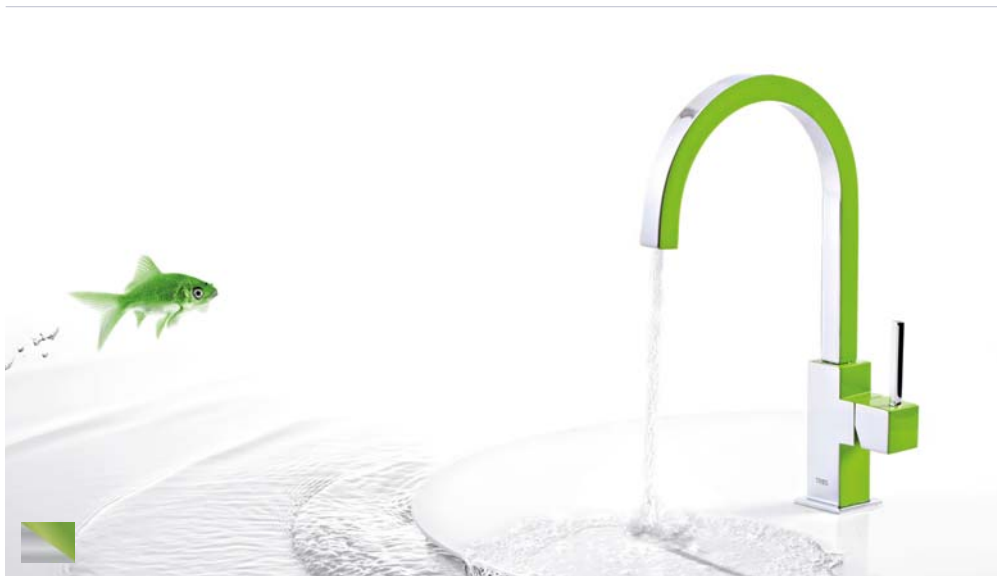

Single lever single hole sink mixer
Tube spout 22x22 mm.

Monocomando lavello verticale
Canna tubo 22x22 mm.

Jednopaková dřezová kuchyňská baterie
ramínko 22x22 mm

- 130497 250,00
- 030497NM 413,00
- 030497BM 413,00
- 53049703 413,00
- 0304970M 501,00
- 130497AM 413,00
- 130497NA 413,00
- 130497RO 413,00
- 130497VI 413,00
- 130497FU 413,00
- 130497VE 413,00
- 630497 413,00
- 430497 413,00

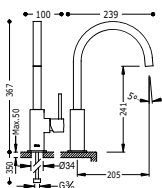

Single lever single hole sink mixer
Tube spout 35x15 mm.

Monocomando lavello verticale
Canna tubo 35x15 mm.

Jednopaková dřezová kuchyňská baterie
ramínko 35x15 mm

- 106440 275,00
- 50644003 454,00

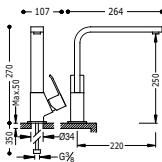

Single lever single hole sink mixer
Tube spout 35x15 mm.

Monocomando lavello verticale
Canna tubo 35x15 mm.

Jednopaková dřezová kuchyňská baterie
ramínko 35x15 mm

- 107440 275,00
- 50744003 454,00

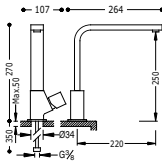

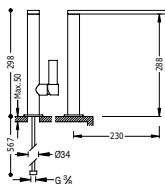

**Single lever single hole sink mixer
spout 34x9 mm.**

**Monocomando lavello verticale
canna 34x9 mm.**

*Jednopáková dřezová kuchyňská baterie
ramínko 34x9 mm*



- 20548601 **212,00**
- M 20548601NM **350,00**
- 20548601BM **350,00**
- 20548601AC **350,00**
- 20548601OM **424,00**

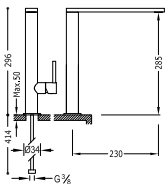

**Single lever single hole sink mixer
spout 34x9 mm.**

**Monocomando lavello verticale
canna 34x9 mm.**

*Jednopáková dřezová kuchyňská baterie
ramínko 34x9 mm*



- 06248801 **220,00**

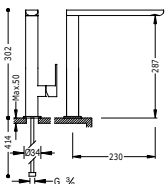

**Single lever single hole sink mixer
spout 34x15 mm.**

**Monocomando lavello verticale
canna 34x15 mm.**

*Jednopáková dřezová kuchyňská baterie
ramínko 34x15 mm*



- 20044001 **230,00**
- M 20044001NM **379,00**
- 20044001BM **379,00**
- 20044001AC **379,00**
- 20044001OM **459,00**
- 20044001AM **379,00**
- 20044001NA **379,00**
- 20044001RO **379,00**
- 20044001VI **379,00**
- 20044001FU **379,00**
- 20044001VE **379,00**
- 20044001NE **379,00**
- 20044001BL **379,00**



Single lever single hole sink mixer
Tube spout 35x15 mm.

Monocomando lavello verticale
Canna tubo 35x15 mm.

Jednopáková dřezová kuchyňská baterie
ramínko 35x15 mm

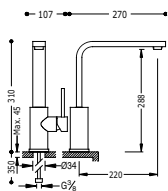

9134592

- 162435 **202,00**
- M 062435NM **334,00**
- M 062435BM **334,00**
- 062435AC **334,00**
- 24 062435OM **404,00**

Single lever single hole sink mixer

Monocomando lavello verticale

Jednopáková dřezová kuchyňská baterie

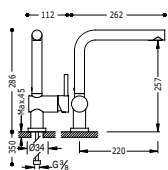

9134288

- 130336 **183,00**
- M 030336BM **303,00**
- 030336AC **303,00**

Single lever single hole sink mixer

Monocomando lavello verticale

Jednopáková dřezová kuchyňská baterie

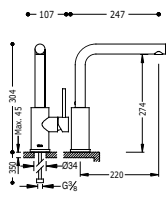

9134592

- 162436 **177,00**
- M 06243601NM **293,00**
- M 06243601BM **293,00**
- 06243601AC **293,00**
- 24 06243601OM **354,00**

Single lever single hole sink mixer

Monocomando lavello verticale

Jednopáková dřezová kuchyňská baterie

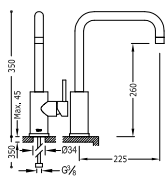

9134592

- 162541 **211,00**

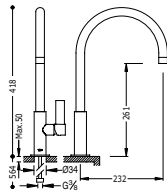

Single lever single hole sink mixer
Monocomandoavello verticale
Jednopáková dřezová kuchyňská baterie

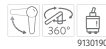

9130190

	20544001	166,00
	20544001NM	274,00
	20544001BM	274,00
	20544001AC	274,00
	20544001OM	332,00

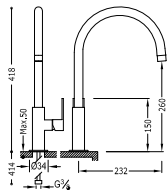

Single lever single hole sink mixer
Monocomandoavello verticale
Jednopáková dřezová kuchyňská baterie

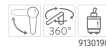

9130190

	20044002	180,00
	20044002NM	298,00
	20044002BM	298,00
	20044002AC	298,00
	20044002AM	298,00
	20044002NA	298,00
	20044002RO	298,00
	20044002VI	298,00
	20044002FU	298,00
	20044002VE	298,00
	20044002NE	298,00
	20044002BL	298,00

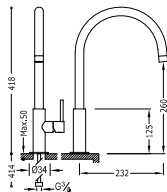

Single lever single hole sink mixer
Monocomandoavello verticale
Jednopáková dřezová kuchyňská baterie

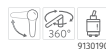

9130190

	06254201	173,00
	06254201NM	286,00
	06254201BM	286,00
	06254201AC	286,00
	06254201OM	346,00

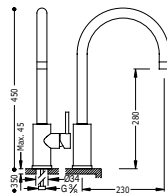

Single lever single hole sink mixer
Monocomandoavello verticale
Jednopáková dřezová kuchyňská baterie

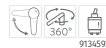

9134692

	162540	200,00
--	--------	--------

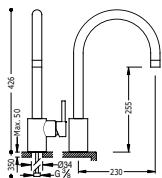

Single lever single hole sink mixer
Monocomandoavello verticale
Jednopáková dřezová kuchyňská baterie



■ 162440 151,00

■ 56244003 250,00

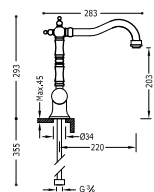

Single lever single hole sink mixer
Monocomandoavello verticale
Jednopáková dřezová kuchyňská baterie



■ 24234101 244,00

■ 24234101AC 404,00

■ 24234101OR 488,00

■ 24234101LV 342,00

■ 24234101LM 342,00

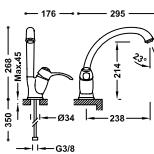

Single lever single hole sink mixer
Monocomandoavello verticale
Jednopáková dřezová kuchyňská baterie



■ 24244101 185,00

■ 24244101AC 306,00

■ 24244101OR 371,00

■ 24244101LV 260,00

■ 24244101LM 260,00

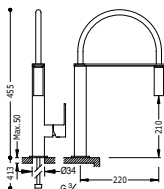

Single lever single hole sink mixer with removable spout

Monocomando lavello verticale estraibile

Jednopáková dřezová kuchyňská baterie s vyjímatelným kropítkem

00648701 372,00

M 00648701NM 614,00

M 00648701BM 614,00

00648701AC 614,00

00648701AM 614,00

00648701NA 614,00

00648701RO 614,00

00648701VI 614,00

00648701FU 614,00

00648701VE 614,00

00648701NE 614,00

00648701BL 614,00

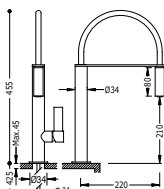

Single lever single hole sink mixer with removable spout

Monocomando lavello verticale estraibile

Jednopáková dřezová kuchyňská baterie s vyjímatelným kropítkem

20548702 333,00

M 20548702NM 614,00

M 20548702BM 614,00

20548702AC 614,00

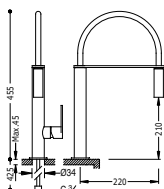

Single lever single hole sink mixer with removable spout

Monocomando lavello verticale estraibile

Jednopáková dřezová kuchyňská baterie s vyjímatelným kropítkem

03048701 333,00

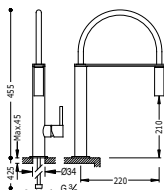

Single lever single hole sink mixer with removable spout

Monocomando lavello verticale estraibile

Jednopáková dřezová kuchyňská baterie s vyjímatelným kropítkem

06248702 333,00



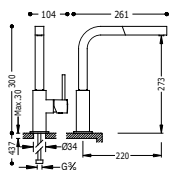

Single lever single hole sink mixer with removable spout

Monocomando livello verticale estraibile

Jednopáková dřezová kuchyňská baterie s vyjímatelným kropicítkem



106437 316,00

M 006437NM 522,00

M 006437BM 522,00

50643703 522,00

24 006437OM 632,00

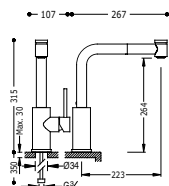

Single lever single hole sink mixer with removable spout (2 operations)

Monocomando livello verticale estraibile (2 funzioni)

Jednopáková dřezová kuchyňská baterie s vyjímatelnou sprškou (2 funkce)



162438 209,00

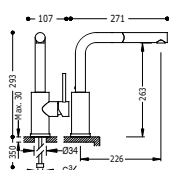

Single lever single hole sink mixer with removable spout

Monocomando livello verticale estraibile

Jednopáková dřezová kuchyňská baterie s vyjímatelným kropicítkem



162437 209,00

56243703 345,00

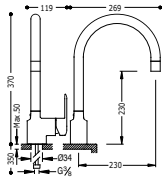

Single lever single hole sink mixer with removable spout

Monocomandoavello verticale estraibile

Jednopáková dřezová baterie svislá s vyjímatelným kropítkem



114444

241,00

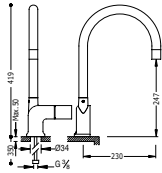

Single lever single hole sink mixer with removable spout

Monocomandoavello verticale estraibile

Jednopáková dřezová baterie svislá s vyjímatelným kropítkem



187444

268,00

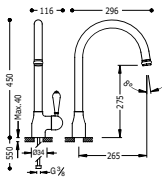

Single lever single hole sink mixer with removable spout

Monocomandoavello verticale estraibile

Jednopáková dřezová kuchyňská baterie s vyjímatelným kropítkem



130432

324,00



Single lever single hole sink mixer FOLDING
Monocomandoavello verticale ABBATTIBILE
Jednopáková dřezová kuchyňská baterie SKLOPNÁ

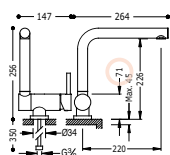

9134-38510

	130335	196,00
	030335NM	323,00
	030335BM	323,00
	030335AC	323,00
	030335OM	391,00

Single hole sink mixer FOLDING
Monocomandoavello verticale ABBATTIBILE
Jednopáková dřezová kuchyňská baterie SKLOPNÁ

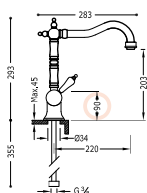

9134-5591

	24233401	310,00
	24233401AC	512,00
	24233401OR	620,00
	24233401LV	435,00
	24233401LM	435,00



161445
Only cold water
 Un'acqua
 Pro studenou vodu
 (nebo vstupně smíšenou)

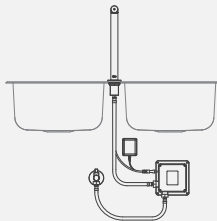

161446
Cold and warm water
 Miscelatore
 Se směšovačem

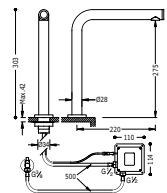
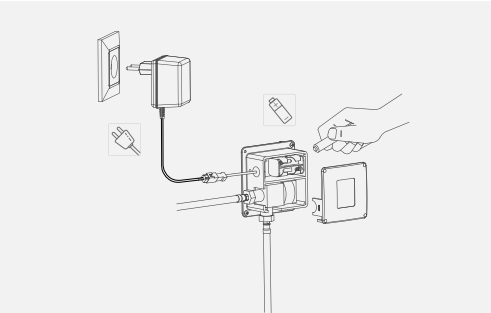
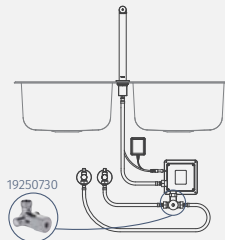

TOUCH-TRES 1 water electronic tap
 Sensitive system to the touch. No press.

Cucina elettronica 1 acqua TOUCH-TRES
 Sistema sensibile al tatto. Senza premere.

Elektronická dřezová kuchyňská baterie na 1 vodu TOUCH-TRES
 Dotyková. Pouze na dotek (NESMÍ se stisknout)



161445

246,00

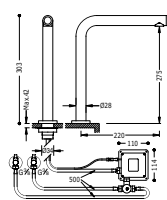

TOUCH-TRES electronic mixer tap

Sensitive system to the touch. No press. NOTE: Includes a hot and cold mixer tap with flexible pipes (for Nr.: 19250730).

Cucina elettronica miscelatore TOUCH-TRES
 Sistema sensibile al tatto. Senza premere. Nota: include un rubinetto miscelatore a due acque con tubi flessibili (per ref.: 19250730).

Elektronická dřezová kuchyňská baterie směsná TOUCH-TRES
 Dotyková. Pouze na dotek (NESMÍ se stisknout). POZNÁMKA: Obsahuje směsnou baterii pro teplou i studenou vodu s ohebnými hadicemi (Kód: 19250730).



161446

289,00

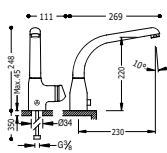

Electronic sink mixer
 Cold and warm water

Monocomando cucina elettronico
 Miscelatore

Jednopávková elektronická kuchyňská baterie
 Směšovací baterie



192445

507,00

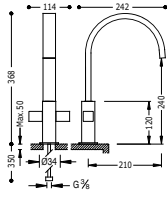

Single hole sink mixer
Tube spout 35x15 mm. Rectangular Areator
Monoblocco lavello verticale
Canna tubo 35x15 mm. Aeratore rettangolare
Dvoupáková dřezová kuchyňská baterie
ramínko 35x15 mm se skrytým obdélníkovým perlátorem



108498 243,00

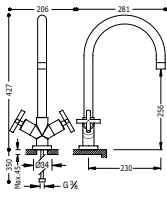

Single hole sink mixer
Monoblocco lavello verticale
Dvoupáková dřezová kuchyňská baterie



163333 230,00

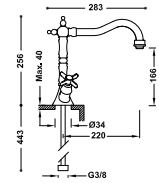

Single hole sink mixer
Monoblocco lavello verticale
Dvoupáková dřezová kuchyňská baterie



24234201 176,00

- 24234201AC 292,00
- 24234201OR 352,00
- 24234201LV 247,00
- 24234201LM 247,00

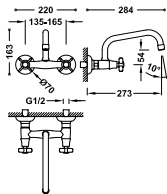

Wall sink mixer
Distance from wall 273 mm.
Monoblocco lavello parete
Distanza da parete di 273 mm.
Nástěnný dřezový celek
vzdálenost od zdi 273 mm



24221501 179,00

- 24221501AC 297,00
- 24221501LV 251,00
- 24221501LM 251,00
- 24221501OR 358,00

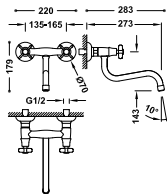

Wall sink mixer
Distance from wall 273 mm.
Monoblocco lavello parete
Distanza da parete di 273 mm.
Nástěnný dřezový celek
vzdálenost od zdi 273 mm



24231001 179,00

- 24231001AC 297,00
- 24231001LV 251,00
- 24231001LM 251,00
- 24231001OR 358,00

186 /



188 / 1 way | vie | cestná



206 / 3 ways | vie | cestná



230 /



232 / 1 way | vie | cestná



239 / 3 ways | vie | cestná



190 / 2 ways | vie | cestná



222 / 4 ways | vie | cestná



233 / 2 ways | vie | cestná



243 / 4 ways | vie | cestná



BLOCK SYSTEM



www.qrtr.es/block-system



Chrome
Cromato
Chrom



Matt Black
Nero Opaco
Černá mat



Matt White
Bianco Opaco
Bílá mat



Steel
Acciaio
Ocel



Metallic black
Nero metallizzato
Metalická černá barva



Brushed metallic black
Nero metallizzato spazzolato
Metalická černá barva kartáčovaná



Gold 24K
Oro 24K
Zlato 24K



Matt gold 24K
Oro 24K Opaco
Zlato 24K mat



Rose gold 24K
Oro rosa 24K
Růžové zlato 24K



Amber
Ambra
Jantarová



Orange
Arancione
Oranžová



Red
Rosso
Červená



Purple
Viola
Fialová



Fuchsia
Fucsia
Fuchsiová



Green
Verde
Zelená



Black
Nero
Černá



White
Bianco
Bílá



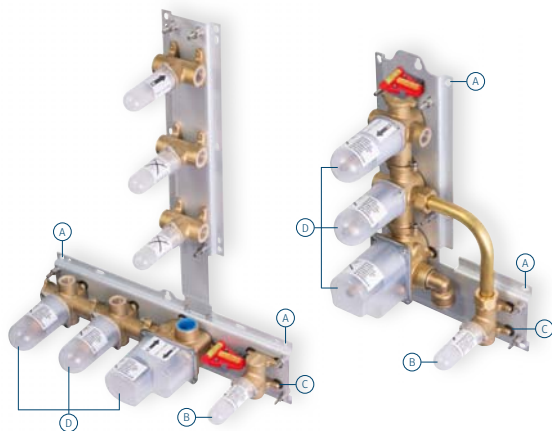

Easy to install
Facile da installare
Snadná instalace

- (A)** Wall-mounted or plasterboard installation profile with 3 levelling axes. / Profilo di installazione a parete o cartongesso con 3 assi di livellamento. / Profil pro upevnění na zedě či sádkokarton se 3 úrovněmi vyvážení.
- (B)** Base with built-in shower connection. / Supporto con attacco doccia integrato. / Nosník se sprchovým taliřem je součástí sestavy.
- (C)** Anti-vibration shock absorbers. / Ammortizzatori antivibrazioni. / Antivibrační tlumiče.
- (D)** Water-tight protectors. The wall is protected from moisture. / Protettori a tenuta. La parete rimane protetta dall'umidità. / Těsnící protektory stěna je dokonale chráněna proti vlhkosti.

BLOCK SYSTEM

The heart of the built-in tap

Il cuore dell'incasso

Zabudovaný instalační systém

Built-in Block System tapware is a solution that offers top quality and a high level of aesthetic achievement. With its compact features, it is available in both square and rounded patterns, creating trends in visual design and giving bathrooms greater space and visual breadth.

Il sistema di rubinetteria da incasso Block System è una proposta che offre grande qualità e alto livello estetico. Con un forma compatta, è disponibile in design squadrati o arrotondati che seguono le tendenze attuali e dotano il bagno di maggior spazio e ampiezza visiva.

Zabudovaný instalační systém baterii Block System je produkt vynikající kvality s vysokou estetickou úrovní. Má kompaktní fyziognomii a je dostupný v hranatých nebo zaoblených tvarech, jež určují současné trendy a koupelnám poskytují větší vizuální prostor.



A reliable cartridge

They have the patented Tres-Instant 57 system built in. This is a cartridge that provides a constant flow, despite pressure and temperature variations.

Una cartuccia affidabile

Includono il sistema brevettato Tres-Instant 57. Una cartuccia che fornisce una portata costante in caso di variazioni di pressione e di temperatura.

Spolehlivá kartuš

Obsahují patentovaný systém Tres-Instant 57. Jedná se o kartuš s konstantním průtokem vody, navzdory kolísání tlaku a teploty.



From 1 to 4 different water outlets

Built-in cartridges with 1-4 outlets. In models with 3 or more outlets, there is the option of using two outlets simultaneously.

1-4 uscite d'acqua distinte

Cartucce deviatrici integrate da 1 a 4 vie. A partire da 3 vie, possibilità di usare due vie simultaneamente.

1 až 4 různé výstupy pro vodu

Zabudované distribuční kartuše s 1 až 4 výstupy. U kartuši se 3 a více výstupy je možno použít dva výstupy současně.



Easy maintenance

The patented Easy-Clean technology ensures maximum cleaning made simple: the disassembly of the handle joined to the cartridge prevents having to recalibrate the system when it is reinstalled.

Facile manutenzione

La tecnologia brevettata Easy-Clean assicura la massima pulizia in modo semplice: lo smontaggio della manopola unita alla cartuccia evita di dover calibrarla nuovamente quando viene reinstallata.

Snadná údržba

Patentovaná technologie Easy-Clean snadným způsobem zaručuje maximální čistotu: demontáž ovládací hlavice včetně kartuše umožňuje zachovat nastavení i po jejím zpětném zasazení.

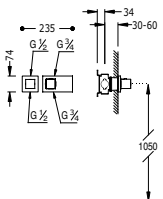
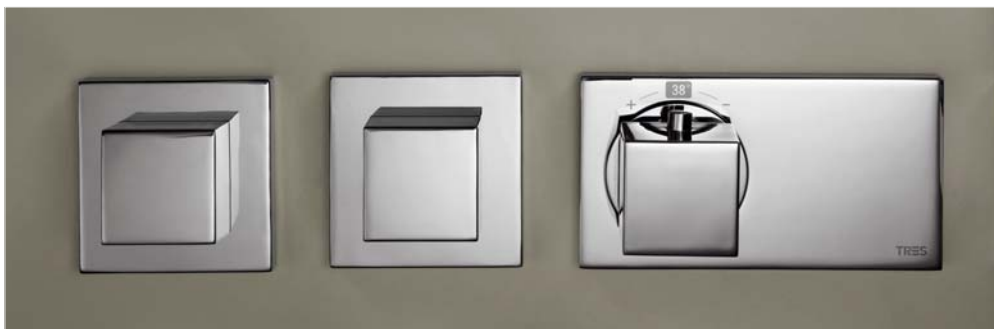

Concealed thermostatic mixer BLOCK SYSTEM

with water shut off and flow control (1 way).
 • Built-in thermostatic body included.

Termostatica ad incasso BLOCK SYSTEM
 Con chiusura e regolazione di portata (1 via).
 • Corpo incassato termostatico incluso.

Termostatická podomítková baterie BLOCK SYSTEM
 s uzávěrem a regulací průtoku (1-cestná).
 • Včetně podomítkového termostatického tělesa.



29925045	29925045AC	
29925045NM	29925045OR	
29925045BM	29925045OM	

20725199	536,00
20725199NM	884,00
20725199BM	884,00
20725199AC	884,00
24 20725199OR	1.071,00
24 20725199OM	1.071,00

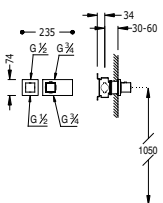

Concealed thermostatic mixer BLOCK SYSTEM

with water shut off and flow control (2 ways).
 • Built-in thermostatic body included.

Termostatica ad incasso BLOCK SYSTEM
 Con chiusura e regolazione di portata (2 vie).
 • Corpo incassato termostatico incluso.

Termostatická podomítková baterie BLOCK SYSTEM
 s uzávěrem a regulací průtoku (2-cestná).
 • Včetně podomítkového termostatického tělesa.



29925045	29925045AC	
29925045NM	29925045OR	
29925045BM	29925045OM	

20725299	536,00
20725299NM	884,00
20725299BM	884,00
20725299AC	884,00
24 20725299OR	1.071,00
24 20725299OM	1.071,00

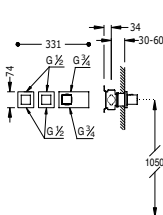

Concealed thermostatic mixer BLOCK SYSTEM

with water shut off and flow control (3 ways).
 • Built-in thermostatic body included.

Termostatica ad incasso BLOCK SYSTEM
 Con chiusura e regolazione di portata (3 vie).
 • Corpo incassato termostatico incluso.

Termostatická podomítková baterie BLOCK SYSTEM
 s uzávěrem a regulací průtoku (3-cestná).
 • Včetně podomítkového termostatického tělesa.



29925045	29925045AC	
29925045NM	29925045OR	
29925045BM	29925045OM	

20725399	706,00
20725399NM	1.165,00
20725399BM	1.165,00
20725399AC	1.165,00
24 20725399OR	1.411,00
24 20725399OM	1.411,00

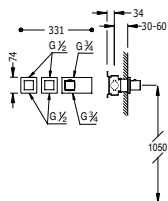

Concealed thermostatic mixer BLOCK SYSTEM with water shut off and flow control (4 ways).
 - Built-in thermostatic body included.

29925045	29925045AC	
29925045NM	29925045OR	
29925045BM	29925045OM	

Termostatica ad incasso BLOCK SYSTEM
 Con chiusura e regolazione di portata (4 vie).
 - Corpo incassato termostatico incluso.

20725499	706,00
----------	--------

Termostatická podomítková baterie BLOCK SYSTEM s uzávěrem a regulací průtoku (4-cestná).
 - Včetně podomítkového termostatického tělesa.

M 20725499NM	1.165,00
M 20725499BM	1.165,00
20725499AC	1.165,00
24 20725499OR	1.411,00
24 20725499OM	1.411,00

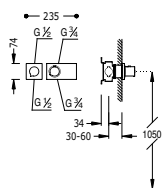

Concealed thermostatic mixer BLOCK SYSTEM with water shut off and flow control (1 way).
 - Built-in thermostatic body included.

29916401	29916401AC	
29916401NM	29916401OR	
29916401BM	29916401OM	

Termostatica ad incasso BLOCK SYSTEM
 Con chiusura e regolazione di portata (1 via).
 - Corpo incassato termostatico incluso.

20735199	525,00
----------	--------

Termostatická podomítková baterie BLOCK SYSTEM s uzávěrem a regulací průtoku (1-cestná).
 - Včetně podomítkového termostatického tělesa.

M 20735199NM	867,00
M 20735199BM	867,00
20735199AC	867,00
24 20735199OR	1.051,00
24 20735199OM	1.051,00

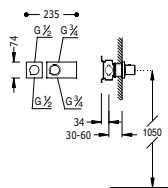

Concealed thermostatic mixer BLOCK SYSTEM with water shut off and flow control (2 ways).
 - Built-in thermostatic body included.

29916401	29916401AC	
29916401NM	29916401OR	
29916401BM	29916401OM	

Termostatica ad incasso BLOCK SYSTEM
 Con chiusura e regolazione di portata (2 vie).
 - Corpo incassato termostatico incluso.

20735299	525,00
----------	--------

Termostatická podomítková baterie BLOCK SYSTEM s uzávěrem a regulací průtoku (2-cestná).
 - Včetně podomítkového termostatického tělesa.

M 20735299NM	867,00
M 20735299BM	867,00
20735299AC	867,00
24 20735299OR	1.051,00
24 20735299OM	1.051,00

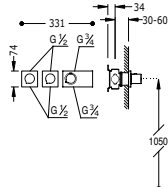

Concealed thermostatic mixer BLOCK SYSTEM with water shut off and flow control (3 ways).
 - Built-in thermostatic body included.

29916401	29916401AC	
29916401NM	29916401OR	
29916401BM	29916401OM	

Termostatica ad incasso BLOCK SYSTEM
 Con chiusura e regolazione di portata (3 vie).
 - Corpo incassato termostatico incluso.

20735399	695,00
----------	--------

Termostatická podomítková baterie BLOCK SYSTEM s uzávěrem a regulací průtoku (3-cestná).
 - Včetně podomítkového termostatického tělesa.

M 20735399NM	1.147,00
M 20735399BM	1.147,00
20735399AC	1.147,00
24 20735399OR	1.391,00
24 20735399OM	1.391,00

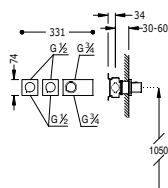

Concealed thermostatic mixer BLOCK SYSTEM with water shut off and flow control (4 ways).
 - Built-in thermostatic body included.

29916401	29916401AC	
29916401NM	29916401OR	
29916401BM	29916401OM	

Termostatica ad incasso BLOCK SYSTEM
 Con chiusura e regolazione di portata (4 vie).
 - Corpo incassato termostatico incluso.

20735499	695,00
----------	--------

Termostatická podomítková baterie BLOCK SYSTEM s uzávěrem a regulací průtoku (4-cestná).
 - Včetně podomítkového termostatického tělesa.

M 20735499NM	1.147,00
M 20735499BM	1.147,00
20735499AC	1.147,00
24 20735499OR	1.391,00
24 20735499OM	1.391,00

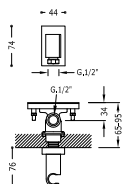

Shower holder BLOCK SYSTEM with adjustable depth wall water inlet fitting and anti-return valve. Built-in body included.

20718202	112,00
----------	--------

Supporto per doccia BLOCK SYSTEM
 con presa d'acqua a parete con profondità regolabile e valvola antiritorno. Corpo incassato incluso.

M 20718202NM	185,00
M 20718202BM	185,00
20718202AC	185,00
24 20718202OR	225,00
24 20718202OM	225,00

Úchyt ruční sprchy se stěnovou přípojkou vody BLOCK SYSTEM
 s nastavitelným výstupem pro vodu a zpětným ventilem. Včetně podomítkového tělesa.

Concealed thermostatic mixer BLOCK SYSTEM with water shut off and flow control (1 way).
 - Built-in thermostatic body included.
 - Anti-limescale hand shower.
 - Shower hose SATIN.

29925045	29925045AC	
29925045NM	29925045OR	
29925045BM	29925045GM	

Termostatica ad incasso BLOCK SYSTEM
 Con chiusura e regolazione di portata (1 via).
 - Corpo incassato termostatico incluso.
 - Doccetta anticalcare.
 - Flessibile satin.

Termostatická podomítková baterie BLOCK SYSTEM s uzavěrem a regulací průtoku (1-cestná).
 - Včetně podomítkového termostatického tělesa.
 - Ruční sprcha, proti usaz. vod. kamene.
 - Flexi hadice SATIN.

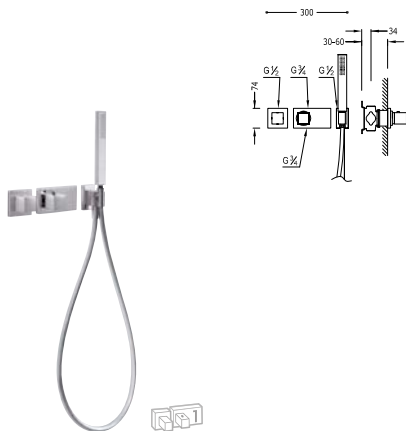

	20725191	666,00
	20725191NM	1.100,00
	20725191BM	1.100,00
	20725191AC	1.100,00
	20725191OR	1.333,00
	20725191GM	1.333,00



Concealed thermostatic mixer BLOCK SYSTEM with water shut off and flow control (1 way).
 - Built-in thermostatic body included.
 - Sliding bar with wall water intake. Length: 760 mm.
 - Anti-limescale hand shower.
 - Shower hose SATIN.

29925045	
----------	--

Termostatica ad incasso BLOCK SYSTEM
 Con chiusura e regolazione di portata (1 via).
 - Corpo incassato termostatico incluso.
 - Barra di scorrimento con presa d'acqua a parete. Lung. 760 mm.
 - Doccetta anticalcare.
 - Flessibile satin.

Termostatická podomítková baterie BLOCK SYSTEM s uzavěrem a regulací průtoku (1-cestná).
 - Včetně podomítkového termostatického tělesa.
 - Posuvná tyč s nástěnným přívodem vody. Délka 760 mm.
 - Ruční sprcha, proti usaz. vod. kamene.
 - Flexi hadice SATIN.



	20725192	796,00
--	----------	---------------



Concealed thermostatic mixer BLOCK SYSTEM

- with water shut off and flow control (1 way).
 • Built-in thermostatic body included.
 • Anti-limescale hand shower.
 • Shower hose SATIN.

29916401	29916401AC	
29916401NM	29916401OR	
29916401BM	29916401OM	

Termostatica ad incasso BLOCK SYSTEM

- Con chiusura e regolazione di portata (1 via).
 • Corpo incassato termostatico incluso.
 • Doccetta anticalcare.
 • Flessibile satin.

Termostatická podomítková baterie BLOCK SYSTEM

- s uzávěrem a regulací průtoku (1-cestná).
 • Včetně podomítkového termostatického tělesa.
 • Ruční sprcha, proti usaz. vod. kamene.
 • Flexi hadice SATIN.

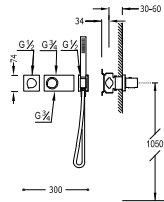

20735191 **679,00**

20735191NM **1.121,00**

20735191BM **1.121,00**

20735191AC **1.121,00**

20735191OR **1.358,00**

20735191OM **1.358,00**



Concealed thermostatic mixer BLOCK SYSTEM

- with water shut off and flow control (1 way).
 • Built-in thermostatic body included.
 • Sliding bar with wall water intake. Length: 760 mm.
 • Anti-limescale hand shower.
 • Shower hose SATIN.

29916401	
----------	--

Termostatica ad incasso BLOCK SYSTEM

- Con chiusura e regolazione di portata (1 via).
 • Corpo incassato termostatico incluso.
 • Barra di scorrimento con presa d'acqua a parete. Lung. 760 mm.
 • Doccetta anticalcare.
 • Flessibile satin.

Termostatická podomítková baterie BLOCK SYSTEM

- s uzávěrem a regulací průtoku (1-cestná).
 • Včetně podomítkového termostatického tělesa.
 • Posuvná tyč s nástěnným přívodem vody. Délka 760 mm.
 • Ruční sprcha, proti usaz. vod. kamene.
 • Flexi hadice SATIN.

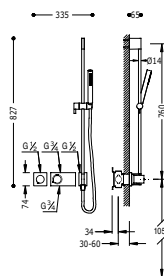

20735192 **785,00**



BLOCK SYSTEM

Concealed thermostatic mixer BLOCK SYSTEM

with water shut off and flow control (2 ways).

- Built-in thermostatic body included.
- Anti-limescale hand shower.
- Shower hose SATIN.

29925045	29925045AC	
29925045NM	29925045OR	
29925045BM	29925045GM	

Termostatica ad incasso BLOCK SYSTEM

Con chiusura e regolazione di portata (2 vie).

- Corpo incassato termostatico incluso.
- Doccetta anticalcare.
- Flessibile satin.

Termostatická podomítková baterie BLOCK SYSTEM

s uzávěrem a regulací průtoku (2-cestná).

- Včetně podomítkového termostatického tělesa.
- Ruční sprcha, proti usaz. vod. kamene.
- Flexi hadice SATIN.

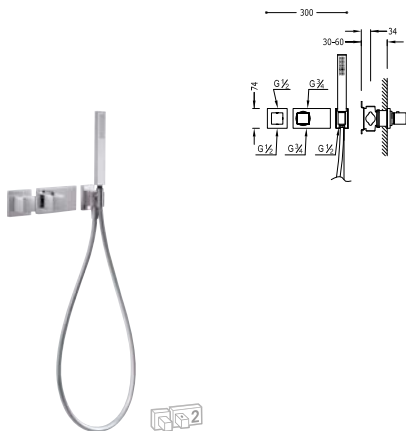

	20725291	666,00
	20725291NM	1.100,00
	20725291BM	1.100,00
	20725291AC	1.100,00
	20725291OR	1.333,00
	20725291GM	1.333,00



Concealed thermostatic mixer BLOCK SYSTEM

with water shut off and flow control (2 ways).

- Built-in thermostatic body included.
- Sliding bar with wall water intake. Length: 760 mm.
- Anti-limescale hand shower.
- Shower hose SATIN.

29925045	
----------	--

Termostatica ad incasso BLOCK SYSTEM

Con chiusura e regolazione di portata (2 vie).

- Corpo incassato termostatico incluso.
- Barra di scorrimento con presa d'acqua a parete. Lung. 760 mm.
- Doccetta anticalcare.
- Flessibile satin.

Termostatická podomítková baterie BLOCK SYSTEM

s uzávěrem a regulací průtoku (2-cestná).

- Včetně podomítkového termostatického tělesa.
- Posuvná tyč s nástěnným přívodem vody. Délka 760 mm.
- Ruční sprcha, proti usaz. vod. kamene.
- Flexi hadice SATIN.

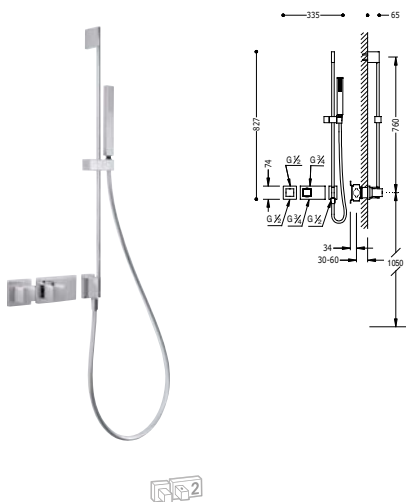

	20725292	796,00
--	----------	---------------



Concealed thermostatic mixer BLOCK SYSTEM

with water shut off and flow control (2 ways).

- Built-in thermostatic body included.
- Anti-limescale hand shower.
- Shower hose SATIN.* NOTE: A shower head, jet or bath spout must be added to the order, depending on installation type

Termostatica ad incasso BLOCK SYSTEM

Con chiusura e regolazione di portata (2 vie).

- Corpo incassato termostatico incluso.
- Doccetta anticalcare.
- Flessibile satin.

Termostatická podomítková baterie BLOCK SYSTEM

s uzávěrem a regulací průtoku (2-cestná).

- Včetně podomítkového termostatického tělesa.
- Ruční sprcha, proti usaz. vod. kamene.
- Flexi hadice SATIN.

29916401	29916401AC	
29916401NM	29916401OR	
29916401BM	29916401OM	

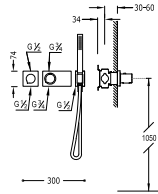

20735291 **679,00**

20735291NM **1.121,00**

20735291BM **1.121,00**

20735291AC **1.121,00**

20735291OR **1.358,00**

20735291OM **1.358,00**



Concealed thermostatic mixer BLOCK SYSTEM

with water shut off and flow control (2 ways).

- Built-in thermostatic body included.
- Sliding bar with wall water intake. Length: 760 mm.
- Anti-limescale hand shower.
- Shower hose SATIN.

Termostatica ad incasso BLOCK SYSTEM

Con chiusura e regolazione di portata (2 vie).

- Corpo incassato termostatico incluso.
- Barra di scorrimento con presa d'acqua a parete. Lung. 760 mm.
- Doccetta anticalcare.
- Flessibile satin.

Termostatická podomítková baterie BLOCK SYSTEM

s uzávěrem a regulací průtoku (2-cestná).

- Včetně podomítkového termostatického tělesa.
- Posuvná tyč s nástěnným přívodem vody. Délka 760 mm.
- Ruční sprcha, proti usaz. vod. kamene.
- Flexi hadice SATIN.

29916401	
----------	--

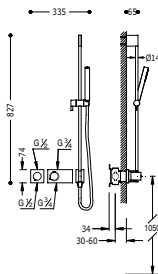

20735292 **785,00**





Concealed thermostatic shower kit BLOCK SYSTEM

- with water shut off and flow control (2 ways).
- Built-in thermostatic body included.
- Fixed shower head 250x250 mm. with ball joint.
- Anti-limescale hand shower.
- Shower hose SATIN.

Kit doccia termostatica ad incasso BLOCK SYSTEM

- Con chiusura e regolazione di portata (2 vie).
- Corpo incassato termostatico incluso.
- Doccia fissa 250x250 mm. con snodo.
- Doccetta anticalcare.
- Flessibile satin.

Termostatický podomítkový sprchový set BLOCK SYSTEM

- s uzávěrem a regulací průtoku (2-cestná).
- Včetně podomítkového termostatického tělesa.
- Pevná sprcha 250x250 mm. s kloubem.
- Ruční sprcha, proti usaz. vod. kamene.
- Flexi hadice SATIN.

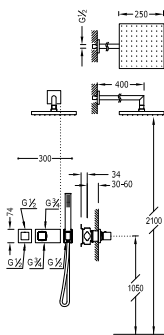

20725211

787,00

Concealed thermostatic shower kit BLOCK SYSTEM

- with water shut off and flow control (2 ways).
- Built-in thermostatic body included.
- Fixed shower head 300x300 mm. with ball joint. Brass.
- Anti-limescale hand shower.
- Shower hose SATIN.

29925045 
 29925045BM  29925045AC 
 29925045RM  29925045OR 
 29925045DM 

Kit doccia termostatica ad incasso BLOCK SYSTEM

- Con chiusura e regolazione di portata (2 vie).
- Corpo incassato termostatico incluso.
- Doccia fissa 300x300 mm. con snodo. Ottone.
- Doccetta anticalcare.
- Flessibile satin.

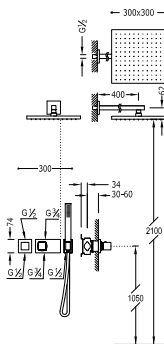

Termostatický podomítkový sprchový set BLOCK SYSTEM

- s uzávěrem a regulací průtoku (2-cestná).
- Včetně podomítkového termostatického tělesa.
- Pevná sprcha 300x300 mm. s kloubem. Materiál mosaz.
- Ruční sprcha, proti usaz. vod. kamene.
- Flexi hadice SATIN.



20725201

890,00

 20725201NM **1.469,00**
 20725201BM **1.469,00**
 20725201AC **1.469,00**
 20725201OR **1.780,00**
 20725201OM **1.780,00**

Concealed thermostatic shower kit BLOCK SYSTEM

with water shut off and flow control (2 ways).

- Built-in thermostatic body included.
- Stainless steel wall shower 210x550 mm.
- Anti-limescale hand shower.
- Shower hose SATIN.

29925045	29925045OR	
29925045NM	29925045OM	
29925045BM	29925045NE	
29925045AC	29925045BL	



Kit doccia termostatica ad incasso BLOCK SYSTEM

Con chiusura e regolazione di portata (2 vie).







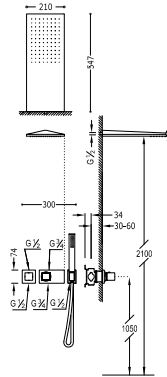

- Corpo incassato termostatico incluso.
- Doccia acciaio inossidabile da parete 210x550 mm.
- Doccetta anticalcare.
- Flessibile satin.

Termostatický podomítkový sprchový set BLOCK SYSTEM

s uzávěrem a regulací průtoku (2-cestná).

- Včetně podomítkového termostatického tělesa.
- Nástěnné sprchové křepítko z nerez. oceli 210x550 mm.
- Ruční sprcha, proti usaz. vod. kamene.
- Flexi hadice SATIN.



	20725202	1.015,00
	20725202NM	1.675,00
	20725202BM	1.675,00
	20725202AC	1.675,00
	20725202OR	2.029,00
	20725202OM	2.029,00
	20725202NE	1.675,00
	20725202BL	1.675,00



Concealed thermostatic shower kit BLOCK SYSTEM

with water shut off and flow control (2 ways).

- Built-in thermostatic body included.
- Stainless steel wall shower 210x550 mm.
- Sliding bar with wall water intake. Length: 760 mm.
- Anti-limescale hand shower.
- Shower hose SATIN.

29925045	
29925045NM	
29925045BM	
29925045AC	



Kit doccia termostatica ad incasso BLOCK SYSTEM

Con chiusura e regolazione di portata (2 vie).





- Corpo incassato termostatico incluso.
- Doccia acciaio inossidabile da parete 210x550 mm.
- Barra di scorrimento con presa d'acqua a parete. Lung. 760 mm.
- Doccetta anticalcare.
- Flessibile satin.

Termostatický podomítkový sprchový set BLOCK SYSTEM

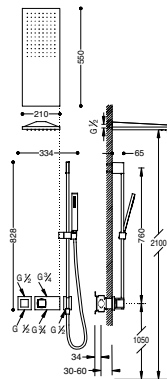
s uzávěrem a regulací průtoku (2-cestná).

- Včetně podomítkového termostatického tělesa.
- Nástěnné sprchové křepítko z nerez. oceli 210x550 mm.
- Posuvná tyč s nástěnným přívodem vody. Délka 760 mm.
- Ruční sprcha, proti usaz. vod. kamene.
- Flexi hadice SATIN.



	20725210	1.121,00
	20725210NM	1.850,00
	20725210BM	1.850,00
	20725210AC	1.850,00



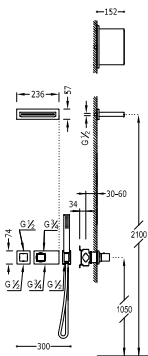

Concealed thermostatic shower kit BLOCK SYSTEM

- with water shut off and flow control (2 ways).
- Built-in thermostatic body included.
- Steel cascade cast spout.
- Anti-limescale hand shower.
- Shower hose SATIN.

29925045 

Kit doccia termostatica ad incasso BLOCK SYSTEM

- Con chiusura e regolazione di portata (2 vie).
- Corpo incassato termostatico incluso.
- Tubo cascata vasca acciaio inossidabile.
- Doccetta anticalcare.
- Flessibile satin.

Termostatický podomítkový sprchový set BLOCK SYSTEM

- s uzávěrem a regulací průtoku (2-cestná).
- Včetně podomítkového termostatického tělesa.
- Ramínko s kaskádou z nerez. oceli.
- Ruční sprcha, proti usaz. vod. kamene.
- Flexi hadice SATIN.



 20725203

951,00

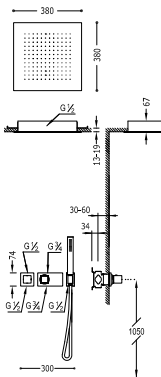

Concealed thermostatic shower kit BLOCK SYSTEM

- with water shut off and flow control (2 ways).
- Built-in thermostatic body included.
- Stainless steel ceiling shower 380x380 mm.
- Anti-limescale hand shower.
- Shower hose SATIN.

29925045 
 29925045MM  29925045OR 
 29925045BM  29925045OM 

Kit doccia termostatica ad incasso BLOCK SYSTEM

- Con chiusura e regolazione di portata (2 vie).
- Corpo incassato termostatico incluso.
- Soffione doccia acciaio inossidabile 380x380 mm.
- Doccetta anticalcare.
- Flessibile satin.

Termostatický podomítkový sprchový set BLOCK SYSTEM

- s uzávěrem a regulací průtoku (2-cestná).
- Včetně podomítkového termostatického tělesa.
- Sprchové kroupitko z nerez. oceli 380x380 mm.
- Ruční sprcha, proti usaz. vod. kamene.
- Flexi hadice SATIN.

 20725204

1.211,00

 20725204NM **1.999,00**

 20725204BM **1.999,00**

 20725204AC **1.999,00**

 20725204OR **2.423,00**

 20725204OM **2.423,00**



29925045 

Concealed thermostatic shower kit BLOCK SYSTEM

- with water shut off and flow control (2 ways).
- Built-in thermostatic body included.
- Stainless steel ceiling shower 500x500 mm.
- Anti-limescale hand shower.
- Shower hose SATIN.

Kit doccia termostatica ad incasso BLOCK SYSTEM

- Con chiusura e regolazione di portata (2 vie).
- Corpo incassato termostatico incluso.
- Soffione doccia acciaio inossidabile 500x500 mm.
- Doccetta anticalcare.
- Flessibile satin.

Termostatický podomítkový sprchový set BLOCK SYSTEM

- s uzávěrem a regulací průtoku (2-cestná).
- Včetně podomítkového termostatického tělesa.
- Sprchové křepítko z nerez. oceli 500x500 mm.
- Ruční sprcha, proti usaz. vod. kamene.
- Flexi hadice SATIN.

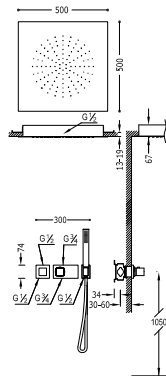

 20725208

1.420,00

29925045 

Concealed thermostatic shower kit BLOCK SYSTEM

- with water shut off and flow control (2 ways).
- Built-in thermostatic body included.
- Stainless steel ceiling shower 500x500 mm.
- Sliding bar with wall water intake. Length: 760 mm.
- Anti-limescale hand shower.
- Shower hose SATIN.

Kit doccia termostatica ad incasso BLOCK SYSTEM

- Con chiusura e regolazione di portata (2 vie).
- Corpo incassato termostatico incluso.
- Soffione doccia acciaio inossidabile 500x500 mm.
- Barra di scorrimento con presa d'acqua a parete. Lung. 760 mm.
- Doccetta anticalcare.
- Flessibile satin.

Termostatický podomítkový sprchový set BLOCK SYSTEM

- s uzávěrem a regulací průtoku (2-cestná).
- Včetně podomítkového termostatického tělesa.
- Sprchové křepítko z nerez. oceli 500x500 mm.
- Posuvná tyč s nástěnným přívodem vody. Délka 760 mm.
- Ruční sprcha, proti usaz. vod. kamene.
- Flexi hadice SATIN.

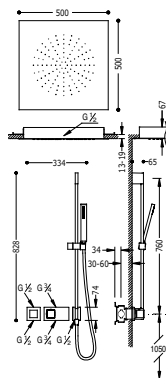

 20725209

1.527,00



Concealed thermostatic shower kit BLOCK SYSTEM CHROMOTHERAPY

- with water shut off and flow control (2 ways).
- Built-in thermostatic body included.
- Stainless steel ceiling shower 500x500 mm.
- Anti-limescale hand shower.
- Shower hose SATIN.

Kit doccia termostatica ad incasso BLOCK SYSTEM CHROMOTHERAPY

- Con chiusura e regolazione di portata (2 vie).
- Corpo incassato termostatico incluso.
- Soffione doccia acciaio inossidabile 500x500 mm.
- Doccetta anticalcare.
- Flessibile satin.

Termostatický podomítkový sprchový set BLOCK SYSTEM CHROMOTHERAPY

- s uzávěrem a regulací průtoku (2-cestně).
- Včetně podomítkového termostatického tělesa.
- Sprchové kropitko z nerez. oceli 500x500 mm.
- Ruční sprcha, proti usaz. vod. kamene.
- Flexi hadice SATIN.

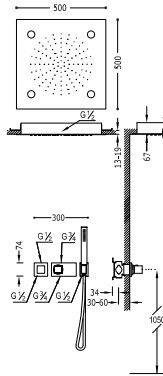

20725205

1.861,00



Concealed thermostatic bath kit BLOCK SYSTEM

with water shut off and flow control (2 ways).

- Built-in thermostatic body included.
- Steel cascade cast spout.
- Anti-limescale hand shower.
- Shower hose SATIN.

Kit termostatico vasca ad incasso BLOCK SYSTEM

Con chiusura e regolazione di portata (2 vie).

- Corpo incassato termostatico incluso.
- Tubo cascata vasca acciaio inossidabile.
- Doccetta anticalcare.
- Flessibile satin.

Termostatický podomítkový vanový set BLOCK SYSTEM

s uzávěrem a regulací průtoku (2-cestná).

- Včetně podomítkového termostatického tělesa.
- Vanové ramínko s kaskádou z nerez. oceli.
- Ruční sprcha proti usaz. vod. kamene.
- Flexi hadice SATIN.

29925045	29925045AC	
29925045NM	29925045OR	
29925045BM	29925045OM	

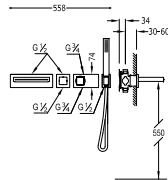

(1)	20719201	951,00
-----	----------	---------------

(1)	M 20719201NM	1.569,00
-----	--------------	-----------------

(1)	M 20719201BM	1.569,00
-----	--------------	-----------------

(1)	20719201AC	1.569,00
-----	------------	-----------------

	24 20719201OR	1.901,00
--	---------------	-----------------

	24 20719201OM	1.901,00
--	---------------	-----------------



Concealed thermostatic bath kit BLOCK SYSTEM

with water shut off and flow control (2 ways).

- Built-in thermostatic body included.
- Bath drain and square CASCADE filling valve with overflow drain.
- Bath PVC drain trap.
- Anti-limescale hand shower.
- Shower hose SATIN.

Kit termostatico vasca ad incasso BLOCK SYSTEM

Con chiusura e regolazione di portata (2 vie).

- Corpo incassato termostatico incluso.
- Scarico vasca e valvola di riempimento quadrata A CASCATA con troppopieno.
- Sifone PVC vasca.
- Doccetta anticalcare.
- Flessibile satin.

Termostatický podomítkový vanový set BLOCK SYSTEM

s uzávěrem a regulací průtoku (2-cestná).

- Včetně podomítkového termostatického tělesa.
- Odtoková a napouštěcí vanová hranatá KASKÁDA s přepladem.
- Vanový sifon z PVC.
- Ruční sprcha, proti usaz. vod. kamene.
- Flexi hadice SATIN.

29925045	
----------	--

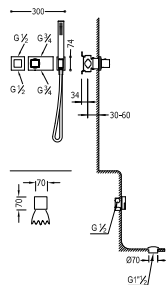

20725206

732,00





**Concealed thermostatic shower kit
BLOCK SYSTEM**

with water shut off and flow control (2 ways).

- Built-in thermostatic body included.
- Fixed shower head Ø 300 mm. with ball joint.
- Brass.
- Anti-limescale hand shower.
- Shower hose SATIN.

29916401	29916401TAM
29916401NM	29916401TNA
29916401BM	29916401TRO
29916401AC	29916401TVI
29916401KM	29916401TFU
29916401KMB	29916401TVE
29916401OR	29916401TNE
29916401OM	29916401TBL
29916401OP	

Kit doccia termostatica ad incasso BLOCK SYSTEM

Con chiusura e regolazione di portata (2 vie).

- Corpo incassato termostatico incluso.
- Doccia fissa Ø 300 mm. con snodo. Ottone.
- Doccetta anticalcare.
- Flessibile satin.

Termostatický podomítkový sprchový set BLOCK SYSTEM

s uzávěrem a regulací průtoku (2-cestná).

- Včetně podomítkového termostatického tělesa.
- Pevná sprcha Ø 300 mm. s kloubem. Materiál Mosaz.
- Ruční sprcha, proti usaz. vod. kamene.
- Flexi hadice SATIN.

(1)	20735201	854,00
-----	----------	--------

(1)	M	20735201NM	1.409,00
(1)	M	20735201BM	1.409,00
(1)		20735201AC	1.409,00
(1)		20735201KM	1.409,00
(1)		20735201KMB	1.409,00
(1)	24	20735201OR	1.708,00
(1)	24	20735201OM	1.708,00
(1)		20735201OP	1.708,00
(1)		20735201TAM	1.409,00
(1)		20735201TNA	1.409,00
(1)		20735201TRO	1.409,00
(1)		20735201TVI	1.409,00
(1)		20735201TFU	1.409,00
(1)		20735201TVE	1.409,00
(1)		20735201TNE	1.409,00
(1)		20735201TBL	1.409,00

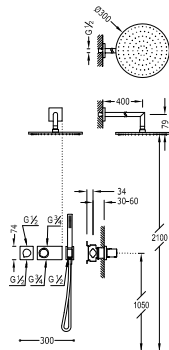

**Concealed thermostatic shower kit
BLOCK SYSTEM**

with water shut off and flow control (2 ways).

- Built-in thermostatic body included.
- Stainless steel wall shower 210x550 mm.
- Anti-limescale hand shower.
- Shower hose SATIN.

29916401	29916401TAM
29916401NM	29916401TNA
29916401BM	29916401TRO
29916401AC	29916401TVI
29916401KM	29916401TFU
29916401KMB	29916401TVE
29916401OR	29916401TNE
29916401OM	29916401TBL
29916401OP	

Kit doccia termostatica ad incasso BLOCK SYSTEM

Con chiusura e regolazione di portata (2 vie).

- Corpo incassato termostatico incluso.
- Doccia acciaio inossidabile da parete 210x550 mm.
- Doccetta anticalcare.
- Flessibile satin.

Termostatický podomítkový sprchový set BLOCK SYSTEM

s uzávěrem a regulací průtoku (2-cestná).

- Včetně podomítkového termostatického tělesa.
- Nástěnné sprchové křepitko z nerez. oceli 210x550 mm.
- Ruční sprcha, proti usaz. vod. kamene.
- Flexi hadice SATIN.

(1)	20735202	1.084,00
-----	----------	----------

(1)	M	20735202NM	1.788,00
(1)	M	20735202BM	1.788,00
(1)		20735202AC	1.788,00
(1)	24	20735202OR	2.167,00
(1)	24	20735202OM	2.167,00
(1)		20735202OP	2.167,00
(1)		20735202AM	1.788,00
(1)		20735202ANA	1.788,00
(1)		20735202RO	1.788,00
(1)		20735202VI	1.788,00
(1)		20735202FU	1.788,00
(1)		20735202VE	1.788,00
(1)		20735202NE	1.788,00
(1)		20735202BL	1.788,00

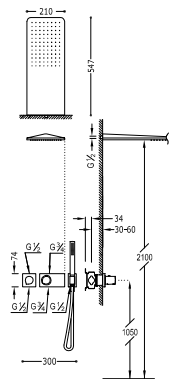

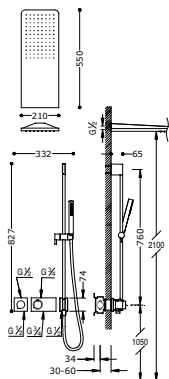

Concealed thermostatic shower kit BLOCK SYSTEM

with water shut off and flow control (2 ways).

- Built-in thermostatic body included.
- Stainless steel wall shower 210x550 mm.
- Sliding bar with wall water intake. Length: 760 mm.
- Anti-limescale hand shower.
- Shower hose SATIN.

29916401
29916401NM
29916401BM
29916401AC



Kit doccia termostatica ad incasso BLOCK SYSTEM

Con chiusura e regolazione di portata (2 vie).

- Corpo incassato termostatico incluso.
- Doccia acciaio inossidabile da parete 210x550 mm.
- Barra di scorrimento con presa d'acqua a parete. Lung. 760 mm
- Doccetta anticalcare.
- Flessibile satin.

Termostatický podomítkový sprchový set BLOCK SYSTEM

s uzávěrem a regulací průtoku (2-cestná).

- Včetně podomítkového termostatického tělesa.
- Nástěnné sprchové křepítko z nerez. oceli 210x550 mm.
- Posuvná tyč s nástěnným přívodem vody. Délka 760 mm.
- Ruční sprcha, proti usaz. vod. kamene.
- Flexi hadice SATIN.

20735210 1.182,00

20735210NM 1.952,00

20735210BM 1.952,00

20735210AC 1.952,00



Concealed thermostatic shower kit BLOCK SYSTEM

with water shut off and flow control (2 ways).

- Built-in thermostatic body included.
- Steel cascade cast spout.
- Anti-limescale hand shower.
- Shower hose SATIN.

29916401

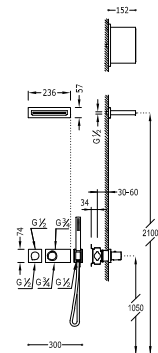

Kit doccia termostatica ad incasso BLOCK SYSTEM

Con chiusura e regolazione di portata (2 vie).

- Corpo incassato termostatico incluso.
- Tubo cascata vasca acciaio inossidabile.
- Doccetta anticalcare.
- Flessibile satin.

Termostatický podomítkový sprchový set BLOCK SYSTEM

s uzávěrem a regulací průtoku (2-cestná).

- Včetně podomítkového termostatického tělesa.
- Ramínko s kaskádou z nerez. oceli.
- Ruční sprcha, proti usaz. vod. kamene.
- Flexi hadice SATIN.

20735203

941,00



Concealed thermostatic shower kit BLOCK SYSTEM

with water shut off and flow control (2 ways).

- Built-in thermostatic body included.
- Stainless steel ceiling shower \varnothing 380 mm.
- Anti-limescale hand shower.
- Shower hose SATIN.

29916401	29916401AC	
29916401NM	29916401OR	
29916401BM	29916401OM	

Kit doccia termostatica ad incasso BLOCK SYSTEM

Con chiusura e regolazione di portata (2 vie).

- Corpo incassato termostatico incluso.
- Soffione doccia acciaio inossidabile \varnothing 380 mm.
- Doccetta anticalcare.
- Flessibile satin.

Termostatický podomítkový sprchový set BLOCK SYSTEM

s uzávěrem a regulací průtoku (2-cestná).

- Včetně podomítkového termostatického tělesa.
- Sprchové křepítko z nerez. oceli \varnothing 380 mm.
- Ruční sprcha, proti usaz. vod. kamene.
- Flexi hadice SATIN.

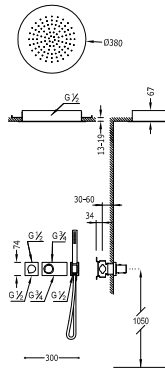

20735204 **1.257,00**

20735204NM **2.073,00**

20735204BM **2.073,00**

20735204AC **2.073,00**

20735204OR **2.513,00**

20735204OM **2.513,00**



Concealed thermostatic shower kit BLOCK SYSTEM

with water shut off and flow control (2 ways).

- Built-in thermostatic body included.
- Stainless steel ceiling shower \varnothing 500 mm.
- Anti-limescale hand shower.
- Shower hose SATIN.

29916401	
----------	--

Kit doccia termostatica ad incasso BLOCK SYSTEM

Con chiusura e regolazione di portata (2 vie).

- Corpo incassato termostatico incluso.
- Soffione doccia acciaio inossidabile \varnothing 500 mm.
- Doccetta anticalcare.
- Flessibile satin.

Termostatický podomítkový sprchový set BLOCK SYSTEM

s uzávěrem a regulací průtoku (2-cestná).

- Včetně podomítkového termostatického tělesa.
- Sprchové křepítko z nerez. oceli \varnothing 500 mm.
- Ruční sprcha, proti usaz. vod. kamene.
- Flexi hadice SATIN.

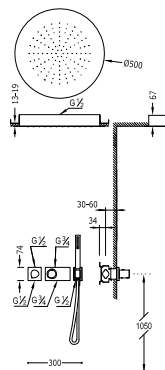

20735211 **1.411,00**



**Concealed thermostatic bath kit
BLOCK SYSTEM**
with water shut off and flow control (2 ways).
- Built-in thermostatic body included.
- Steel cascade cast spout.
- Anti-limescale hand shower.
- Shower hose SATIN.

Kit termostatico vasca ad incasso BLOCK SYSTEM
Con chiusura e regolazione di portata (2 vie).
- Corpo incassato termostatico incluso.
- Tubo cascata vasca acciaio inossidabile.
- Doccetta anticalcare.
- Flessibile satin.

Termostatický podomítkový vanový set BLOCK SYSTEM
s uzávěrem a regulací průtoku (2-cestná).
- Včetně podomítkového termostatického tělesa.
- Vanové ramínko s hšhádkou z nerez. oceli.
- Ruční sprcha, proti usaz. vod. kamene.
- Flexi hadice SATIN.

29916401 29916401AC
29916401NM 29916401OR
29916401BM 29916401OM

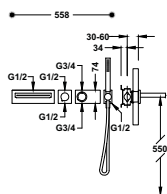

20739201 941,00

M 20739201NM 1.554,00

M 20739201BM 1.554,00

20739201AC 1.554,00

2 20739201OR 1.883,00

24 20739201OM 1.883,00



Concealed thermostatic bath kit BLOCK SYSTEM

with water shut off and flow control (2 ways).

- Built-in thermostatic body included.
- Bath spout.
- Anti-limescale hand shower.
- Shower hose SATIN.

Kit termostatico vasca ad incasso BLOCK SYSTEM

Con chiusura e regolazione di portata (2 vie).

- Corpo incassato termostatico incluso.
- Canna per vasca da bagno.
- Doccetta anticalcare.
- Flessibile satin.

Termostatický podomítkový vanový set BLOCK SYSTEM

s uzávěrem a regulací průtoku (2-cestná).

- Včetně podomítkového termostatického tělesa.
- Kohoutek pro vanu.
- Ruční sprcha, proti usaz. vod. kamene.
- Flexi hadice SATIN.

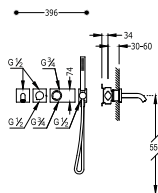

 20735209

732,00

Concealed thermostatic bath kit BLOCK SYSTEM

with water shut off and flow control (2 ways).

- Built-in thermostatic body included.
- Bath spout.
- Anti-limescale hand shower.
- Shower hose SATIN.

Kit termostatico vasca ad incasso BLOCK SYSTEM

Con chiusura e regolazione di portata (2 vie).

- Corpo incassato termostatico incluso.
- Canna per vasca da bagno.
- Doccetta anticalcare.
- Flessibile satin.

Termostatický podomítkový vanový set BLOCK SYSTEM

s uzávěrem a regulací průtoku (2-cestná).

- Včetně podomítkového termostatického tělesa.
- Kohoutek pro vanu.
- Ruční sprcha, proti usaz. vod. kamene.
- Flexi hadice SATIN.

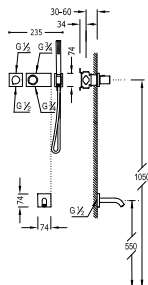



 20735208

798,00

 20735208NM **1.317,00**

 20735208BM **1.317,00**

 20735208AC **1.317,00**

 24 20735208OR **1.597,00**

 24 20735208OM **1.597,00**



29916401 

Concealed thermostatic bath kit BLOCK SYSTEM

with water shut off and flow control (2 ways).

- Built-in thermostatic body included.
- Bath drain and round CASCADE filling valve with overflow drain.
- Bath PVC drain trap.
- Anti-limescale hand shower.
- Shower hose SATIN.

Kit termostatico vasca ad incasso BLOCK SYSTEM

Con chiusura e regolazione di portata (2 vie).

- Corpo incassato termostatico incluso.
- Scarico vasca e valvola di riempimento rotonda A CASCATA con troppopieno.
- Sifone PVC vasca.
- Doccetta anticalcare.
- Flessibile satin.

Termostatický podomítkový vanový set BLOCK SYSTEM

s uzávěrem a regulací průtoku (2-cestná).

- Včetně podomítkového termostatického tělesa.
- Odtoková a napouštěcí vanová kulatá KASKÁDA s přepladem.
- Vanový sifon z PVC.
- Ruční sprcha, proti usaz. vod. kamene.
- Flexi hadice SATIN.

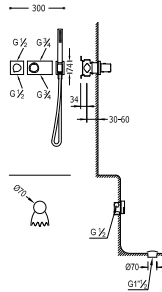

 20735206

721,00

Concealed thermostatic bath kit BLOCK SYSTEM

with water shut off and flow control (2 ways).

- Built-in thermostatic body included.
- Bath drain and round CASCADE filling valve with overflow drain.
- Bath PVC drain trap.
- Massage shower, 5 positions.
- Double interlocked shower hose.

Kit termostatico vasca ad incasso BLOCK SYSTEM

Con chiusura e regolazione di portata (2 vie).

- Corpo incassato termostatico incluso.
- Scarico vasca e valvola di riempimento rotonda A CASCATA con troppopieno.
- Sifone PVC vasca.
- Doccetta massaggio, 5 posizioni.
- Flessibile doppia graffatura.

Termostatický podomítkový vanový set BLOCK SYSTEM

s uzávěrem a regulací průtoku (2-cestná).

- Včetně podomítkového termostatického tělesa.
- Odtoková a napouštěcí vanová kulatá KASKÁDA s přepladem.
- Vanový sifon z PVC.
- Masážní sprcha, 5 funkcí.
- Flexi hadice s dvojitým opletem.

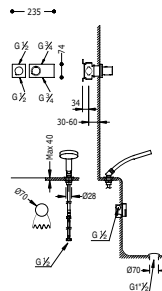

 20735207

743,00



Concealed thermostatic mixer BLOCK SYSTEM with water shut off and flow control (3 ways).
 · Built-in thermostatic body included.
 · Anti-limescale hand shower.
 · Shower hose SATIN.

29925045	29925045AC	
29925045NM	29925045OR	
29925045BM	29925045CM	

Termostatica ad incasso BLOCK SYSTEM
 Con chiusura e regolazione di portata (3 vie).
 · Corpo incassato termostatico incluso.
 · Doccetta anticalcare.
 · Flessibile satin.

Termostatická podomítková baterie BLOCK SYSTEM s uzávěrem a regulací průtoku (3-cestná).
 · Včetně podomítkového termostatického tělesa.
 · Ruční sprcha, proti usaz. vod. kamene.
 · Flexi hadice SATIN.



	20725391	859,00
	20725391NM	1.418,00
	20725391BM	1.418,00
	20725391AC	1.418,00
	20725391OR	1.718,00
	20725391CM	1.718,00



Concealed thermostatic mixer BLOCK SYSTEM with water shut off and flow control (3 ways).
 · Built-in thermostatic body included.
 · Sliding bar with wall water intake. Length: 760 mm.
 · Anti-limescale hand shower.
 · Shower hose SATIN.

29925045	
----------	--

Termostatica ad incasso BLOCK SYSTEM
 Con chiusura e regolazione di portata (3 vie).
 · Corpo incassato termostatico incluso.
 · Barra di scorrimento con presa d'acqua a parete. Lung. 760 mm.
 · Doccetta anticalcare.
 · Flessibile satin.

Termostatická podomítková baterie BLOCK SYSTEM s uzávěrem a regulací průtoku (3-cestná).
 · Včetně podomítkového termostatického tělesa.
 · Posuvná tyč s nástěnným přívodem vody. Délka 760 mm.
 · Ruční sprcha, proti usaz. vod. kamene.
 · Flexi hadice SATIN.

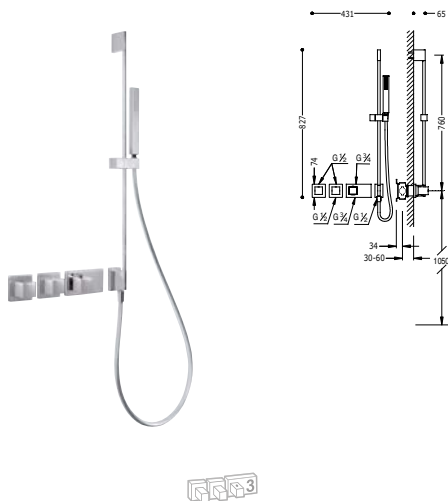

	20725392	965,00
--	----------	---------------



Concealed thermostatic mixer BLOCK SYSTEM

- with water shut off and flow control (3 ways).**
- Built-in thermostatic body included.
 - Anti-limescale hand shower.
 - Shower hose SATIN.

Termostatica ad incasso BLOCK SYSTEM

- Con chiusura e regolazione di portata (3 vie).
- Corpo incassato termostatico incluso.
 - Doccetta anticalcare.
 - Flessibile satin.

Termostatická podomítková baterie BLOCK SYSTEM

- s uzávěrem a regulací průtoku (3-cestná).
- Včetně podomítkového termostatického tělesa.
 - Ruční sprcha, proti usaz. vod. kamene.
 - Flexi hadice SATIN.

29916401	29916401AC	
29916401NM	29916401OR	
29916401BM	29916401OM	

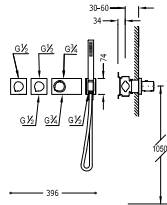

	20735391	849,00
	20735391NM	1.401,00
	20735391BM	1.401,00
	20735391AC	1.401,00
	20735391OR	1.697,00
	20735391OM	1.697,00



Concealed thermostatic mixer BLOCK SYSTEM with water shut off and flow control (3 ways).

- Built-in thermostatic body included.
- Sliding bar with wall water intake. Length: 760 mm.
- Anti-limescale hand shower.
- Shower hose SATIN.

Termostatica ad incasso BLOCK SYSTEM

- Con chiusura e regolazione di portata (3 vie).
- Corpo incassato termostatico incluso.
 - Barra di scorrimento con presa d'acqua a parete. Lung. 760 mm.
 - Doccetta anticalcare.
 - Flessibile satin.

Termostatická podomítková baterie BLOCK SYSTEM

- s uzávěrem a regulací průtoku (3-cestná).
- Včetně podomítkového termostatického tělesa.
 - Posuvná tyč s nástěnným přívodem vody. Délka 760 mm.
 - Ruční sprcha, proti usaz. vod. kamene.
 - Flexi hadice SATIN.

29916401	
----------	--

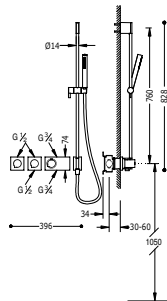

	20735392	955,00
--	----------	---------------



BLOCK SYSTEM

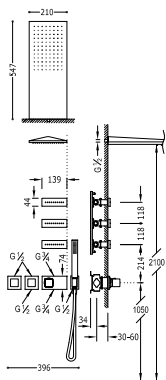

Concealed thermostatic shower kit BLOCK SYSTEM

- with water shut off and flow control (3 ways).
- Built-in thermostatic body included.
- Stainless steel wall shower 210x550 mm.
- 3 Anti-limescale jets. Brass.
- Anti-limescale hand shower.
- Shower hose SATIN.

IMPORTANT: Assemble a drain of >50 l/min.

Kit doccia termostatica ad incasso BLOCK SYSTEM

Con chiusura e regolazione di portata (3 vie).

- Corpo incassato termostatico incluso.
- Doccia acciaio inossidabile da parete 210x550 mm.
- 3 jets anticalcare. Ottone.
- Doccetta anticalcare.
- Flessibile satin.

IMPORTANTE: Montare uno scarico di >50 l/min.

Termostatický podomítkový sprchový set BLOCK SYSTEM

s uzávěrem a regulací průtoku (3-cestná).

- Včetně podomítkového termostatického tělesa.
- Nástěnné sprchové křepítko z nerez. oceli 210x550 mm.
- 3 natáčecí trysky, proti usaz. vod. kamene. Materiál Mosaz.
- Ruční sprcha, proti usaz. vod. kamene.
- Flexi hadice SATIN.

DŮLEŽITÉ: Použijte odtokovou trubici pro průtok >50 l/min.

29925045



20725301

1.634,00

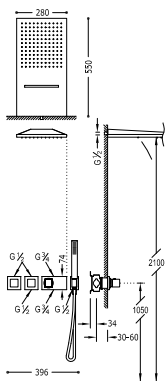

Concealed thermostatic shower kit BLOCK SYSTEM

with water shut off and flow control (3 ways).

- Built-in thermostatic body included.
- Stainless steel wall shower with 2 jet types 280x550 mm.
- Anti-limescale hand shower.
- Shower hose SATIN.

IMPORTANT: Assemble a drain of >50 l/min.

Kit doccia termostatica ad incasso BLOCK SYSTEM

Con chiusura e regolazione di portata (3 vie).

- Corpo incassato termostatico incluso.
- Doccia acciaio inossidabile da parete con 2 tipi di getto 280x550 mm.
- Doccetta anticalcare.
- Flessibile satin.

IMPORTANTE: Montare uno scarico di >50 l/min.

Termostatický podomítkový sprchový set BLOCK SYSTEM

s uzávěrem a regulací průtoku (3-cestná).

- Včetně podomítkového termostatického tělesa.
- Nástěnné sprchové křepítko z nerez. oceli s 2 typů proudění vody 280x550 mm.
- Ruční sprcha, proti usaz. vod. kamene.
- Flexi hadice SATIN.

DŮLEŽITÉ: Použijte odtokovou trubici pro průtok >50 l/min.

29925045
29925045BM
29925045BM
29925045AC

20725302

1.473,00

M 20725302NM

2.431,00

M 20725302BM

2.431,00

M 20725302AC

2.431,00





Concealed thermostatic shower kit BLOCK SYSTEM

with water shut off and flow control (3 ways).

- Built-in thermostatic body included.
- Stainless steel wall shower with 2 jet types 280x550 mm.
- Sliding bar with wall water intake. Length: 760 mm.
- Anti-limescale hand shower.
- Shower hose SATIN.

IMPORTANT: Assemble a drain of >50 l/min.

Kit doccia termostatica ad incasso BLOCK SYSTEM

Con chiusura e regolazione di portata (3 vie).

- Corpo incassato termostatico incluso.
- Doccia acciaio inossidabile da parete con 2 tipi di getto 280x550 mm.
- Barra di scorrimento con presa d'acqua a parete. Lung. 760 mm.
- Doccetta anticalcare.
- Flessibile satin.

IMPORTANTE: Montare uno scarico di >50 l/min.

Termostatický podomítkový sprchový set BLOCK SYSTEM

s uzavěrem a regulací průtoku (3-cestná).

- Včetně podomítkového termostatického tělesa.
- Nástěnné sprchové kropičko z nerez. oceli s 2 typů proudění vody 280x550 mm.
- Posuvná tyč s nástěnným přívodem vody. Délka 760 mm.
- Ruční sprcha, proti usaz. vod. kamene.
- Flexi hadice SATIN.

DŮLEŽITÉ: Použijte odtokovou trubici pro průtok >50 l/min.

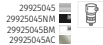
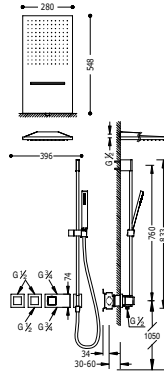

20725309 1.568,00

20725309NM 2.587,00

20725309BM 2.587,00

20725309AC 2.587,00



Concealed thermostatic shower kit BLOCK SYSTEM

with water shut off and flow control (3 ways).

- Built-in thermostatic body included.
- Stainless steel ceiling shower with 2 jet types 500x500 mm.
- Anti-limescale hand shower.
- Shower hose SATIN.

IMPORTANT: Assemble a drain of >50 l/min.

Kit doccia termostatica ad incasso BLOCK SYSTEM

Con chiusura e regolazione di portata (3 vie).

- Corpo incassato termostatico incluso.
- Soffione doccia acciaio inossidabile con 2 tipi di getto 500x500 mm.
- Doccetta anticalcare.
- Flessibile satin.

IMPORTANTE: Montare uno scarico di >50 l/min.

Termostatický podomítkový sprchový set BLOCK SYSTEM

s uzavěrem a regulací průtoku (3-cestná).

- Včetně podomítkového termostatického tělesa.
- Stropní sprchové kropičko z nerez. oceli s 2 typů proudění vody 500x500 mm.
- Ruční sprcha, proti usaz. vod. kamene.
- Flexi hadice SATIN.

DŮLEŽITÉ: Použijte odtokovou trubici pro průtok >50 l/min.

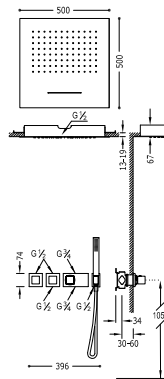

20725303 1.634,00

20725303NM 2.696,00

20725303BM 2.696,00

20725303AC 2.696,00



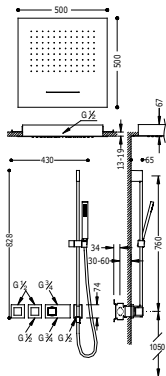

Concealed thermostatic shower kit BLOCK SYSTEM

- with water shut off and flow control (3 ways).
- Built-in thermostatic body included.
- Stainless steel ceiling shower with 2 jet types 500x500 mm.
- Sliding bar with wall water intake. Length: 760 mm.
- Anti-limescale hand shower.
- Shower hose SATIN.

IMPORTANT: Assemble a drain of >50 l/min.

Kit doccia termostatica ad incasso BLOCK SYSTEM

- Con chiusura e regolazione di portata (3 vie).
- Corpo incassato termostatico incluso.
- Soffione doccia acciaio inossidabile con 2 tipi di getto 500x500 mm.
- Barra di scorrimento con presa d'acqua a parete. Lung. 760 mm
- Doccetta anticalcare.
- Flessibile satin.

IMPORTANTE: Montare uno scarico di >50 l/min.

Termostatický podomítkový sprchový set BLOCK SYSTEM s uzávěrem a regulací průtoku (3-cestná).

- Včetně podomítkového termostatického tělesa.
- Stropní sprchové křepítko z nerez. oceli s 2 typů proudění vody 500x500 mm.
- Posuvná tyč s nástěnným přívodem vody. Délka 760 mm.
- Ruční sprcha, proti usaz. vod. kamene.
- Flexi hadice SATIN.

DŮLEŽITÉ: Použijte odtokovou trubici pro průtok >50 l/min.

29925045
29925045NM
29925045BM
29925045AC

20725311 1.729,00

20725311NM 2.854,00

20725311BM 2.854,00

20725311AC 2.854,00



Recommended installation Installazione consigliata Doporučená instalace

This is the installation scheme recommended to enjoy the tap functions to the full.

Questo è uno schema dell'installazione consigliata per ottimizzare le funzioni del rubinetto.

Zde je doporučené schéma pro instalaci, pro zajištění maximálního využití funkcí baterie.

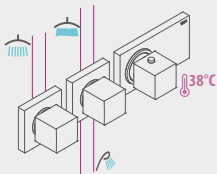

20725311 / 20725311AC / 20725311NM / 20725311BM





Concealed thermostatic shower kit BLOCK SYSTEM

- with water shut off and flow control (3 ways).
- Built-in thermostatic body included.
- Stainless steel ceiling shower with 2 jet types 500x500 mm.
- Anti-limescale hand shower.
- Shower hose SATIN.

IMPORTANT: Assemble a drain of >50 l/min.

Kit doccia termostatica ad incasso BLOCK SYSTEM

Con chiusura e regolazione di portata (3 vie).

- Corpo incassato termostatico incluso.
- Soffione doccia acciaio inossidabile con 2 tipi di getto 500x500 mm.
- Doccetta anticalcare.
- Flessibile satin.

IMPORTANTE: Montare uno scarico di >50 l/min.

Termostatický podomítkový sprchový set BLOCK SYSTEM

s uzávěrem a regulací průtoku (3-cestná).

- Včetně podomítkového termostatického tělesa.
- Stropní sprchové křepítko z nerez. oceli s 2 typů proudění vody 500x500 mm.
- Ruční sprcha, proti usaz. vod. kamene.
- Flexi hadice SATIN.

DŮLEŽITÉ: Použijte odtokovou trubici pro průtok >50 l/min.

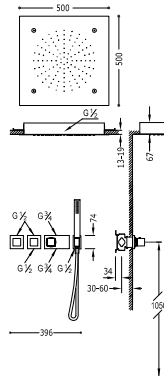

20725312

1.737,00



Concealed thermostatic shower kit BLOCK SYSTEM

- with water shut off and flow control (3 ways).
- Built-in thermostatic body included.
- Stainless steel ceiling shower with 2 jet types 500x500 mm.
- Sliding bar with wall water intake. Length: 760 mm.
- Anti-limescale hand shower.
- Shower hose SATIN.

IMPORTANT: Assemble a drain of >50 l/min.

Kit doccia termostatica ad incasso BLOCK SYSTEM

Con chiusura e regolazione di portata (3 vie).

- Corpo incassato termostatico incluso.
- Soffione doccia acciaio inossidabile con 2 tipi di getto 500x500 mm.
- Barra di scorrimento con presa d'acqua a parete. Lung. 760 mm.
- Doccetta anticalcare.
- Flessibile satin.

IMPORTANTE: Montare uno scarico di >50 l/min.

Termostatický podomítkový sprchový set BLOCK SYSTEM

s uzávěrem a regulací průtoku (3-cestná).

- Včetně podomítkového termostatického tělesa.
- Stropní sprchové křepítko z nerez. oceli s 2 typů proudění vody 500x500 mm.
- Posuvná tyč s nástěnným přívodem vody. Délka 760 mm.
- Ruční sprcha, proti usaz. vod. kamene.
- Flexi hadice SATIN.

DŮLEŽITÉ: Použijte odtokovou trubici pro průtok >50 l/min.

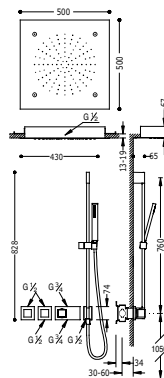

20725313

1.832,00

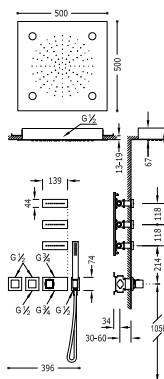

Concealed thermostatic shower kit BLOCK SYSTEM CHROMOTHERAPY

with water shut off and flow control (3 ways).

- Built-in thermostatic body included.
- Stainless steel ceiling shower 500x500 mm.
- 3 Anti-limescale jets. Brass.
- Anti-limescale hand shower.
- Shower hose SATIN.

IMPORTANT: Assemble a drain of >50 l/min.

Kit doccia termostatica ad incasso BLOCK SYSTEM CHROMOTHERAPY

Con chiusura e regolazione di portata (3 vie).

- Corpo incassato termostatico incluso.
- Soffione doccia acciaio inossidabile 500x500 mm.
- 3 jets anticalcare. Ottone.
- Doccetta anticalcare.
- Flessibile satin.

IMPORTANTE: Montare uno scarico di >50 l/min.

Termostatický podomítkový sprchový set BLOCK SYSTEM CHROMOTHERAPY

s uzávěrem a regulací průtoku (3-cestná).

- Včetně podomítkového termostatického tělesa.
- Stropní sprchové křížko z nerez. oceli 500x500 mm.
- 3 natáčecí trysky, proti usaz. vod. kamene. Materiál Mosaz.
- Ruční sprcha, proti usaz. vod. kamene.
- Flexi hadice SATIN.

DŮLEŽITÉ: Použijte odtokovou trubici pro průtok >50 l/min.



20725304

2.478,00





Concealed thermostatic bath kit BLOCK SYSTEM

- with water shut off and flow control (3 ways).
- Built-in thermostatic body included.
- Stainless steel wall shower 210x550 mm.
- Steel cascade cast spout.
- Anti-limescale hand shower.
- Shower hose SATIN.

IMPORTANT: Assemble a drain of >50 l/min.

Kit termostatico vasca ad incasso BLOCK SYSTEM

Con chiusura e regolazione di portata (3 vie).

- Corpo incassato termostatico incluso.
- Doccia acciaio inossidabile da parete 210x550 mm.
- Tubo cascata vasca acciaio inossidabile.
- Doccetta anticalcare.
- Flessibile satin.

IMPORTANTE: Montare uno scarico di >50 l/min.

Termostatický podomítkový vanový set BLOCK SYSTEM

s uzávěrem a regulací průtoku (3-cestná).

- Včetně podomítkového termostatického tělesa.
- Nástěnné sprchové křepítko z nerez. oceli 210x550 mm.
- Vanové ramínko s haskádou z nerez. oceli.
- Ruční sprcha, proti usaz. vod. kamene.
- Flexi hadice SATIN.

DŮLEŽITÉ: Použijte odtokovou trubici pro průtok >50 l/min.

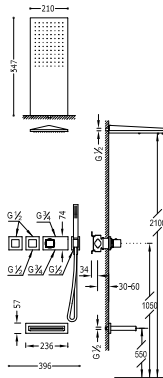

20725305 1.499,00

20725305AC 2.473,00



Concealed thermostatic bath kit BLOCK SYSTEM

- with water shut off and flow control (3 ways).
- Built-in thermostatic body included.
- Stainless steel ceiling shower 380x380 mm.
- Steel cascade cast spout.
- Anti-limescale hand shower.
- Shower hose SATIN.

IMPORTANT: Assemble a drain of >50 l/min.

Kit termostatico vasca ad incasso BLOCK SYSTEM

Con chiusura e regolazione di portata (3 vie).

- Corpo incassato termostatico incluso.
- Soffione doccia acciaio inossidabile 380x380 mm.
- Tubo cascata vasca acciaio inossidabile.
- Doccetta anticalcare.
- Flessibile satin.

IMPORTANTE: Montare uno scarico di >50 l/min.

Termostatický podomítkový vanový set BLOCK SYSTEM

s uzávěrem a regulací průtoku (3-cestná).

- Včetně podomítkového termostatického tělesa.
- Stropní sprchové křepítko z nerez. oceli 380x380 mm.
- Vanové ramínko s haskádou z nerez. oceli.
- Ruční sprcha, proti usaz. vod. kamene.
- Flexi hadice SATIN.

DŮLEŽITÉ: Použijte odtokovou trubici pro průtok >50 l/min.

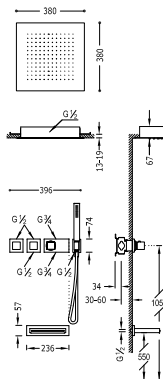

20725306 1.702,00



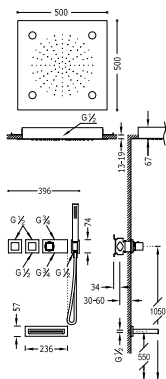

Concealed thermostatic bath kit BLOCK SYSTEM CHROMOTHERAPY

- with water shut off and flow control (3 ways).
- Built-in thermostatic body included.
- Ceiling shower Anti-limescale 500x500 mm.
- Steel cascade cast spout.
- Anti-limescale hand shower.
- Shower hose SATIN.

IMPORTANT: Assemble a drain of >50 l/min.

Kit termostatico vasca ad incasso BLOCK SYSTEM CHROMOTHERAPY

- Con chiusura e regolazione di portata (3 vie).
- Corpo incassato termostatico incluso.
- Soffione doccia anticalcare 500x500 mm.
- Tubo cascata vasca acciaio inossidabile.
- Doccetta anticalcare.
- Flessibile satin.

IMPORTANTE: Montare uno scarico di >50 l/min.

Termostatický podomítkový vanový set BLOCK SYSTEM CHROMOTHERAPY

- s uzávěrem a regulací průtoku (3-cestná).
- Včetně podomítkového termostatického tělesa.
- Stropní sprchové kropičko z nerez. oceli 500x500 mm.
- Vanové ramínko s kaskádou z nerez. oceli.
- Ruční sprcha, proti usaz. vod. kamene.
- Flexi hadice SATIN.

DŮLEŽITÉ: Použijte odtokovou trubici pro průtok >50 l/min.



20725307

2.343,00

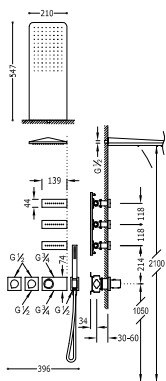

Concealed thermostatic shower kit BLOCK SYSTEM

- with water shut off and flow control (3 ways).
- Built-in thermostatic body included.
- Stainless steel wall shower 210x550 mm.
- 3 Anti-limescale jets. Brass.
- Anti-limescale hand shower.
- Shower hose SATIN.

IMPORTANT: Assemble a drain of >50 l/min.

Kit doccia termostatica ad incasso BLOCK SYSTEM

- Con chiusura e regolazione di portata (3 vie).
- Corpo incassato termostatico incluso.
- Doccia acciaio inossidabile da parete 210x550 mm.
- 3 jets anticalcare. Ottone.
- Doccetta anticalcare.
- Flessibile satin.

IMPORTANTE: Montare uno scarico di >50 l/min.

Termostatický podomítkový sprchový set BLOCK SYSTEM

- s uzávěrem a regulací průtoku (3-cestná).
- Včetně podomítkového termostatického tělesa.
- Nástěnné sprchové kropičko z nerez. oceli 210x550 mm.
- 3 natáčecí trysky, proti usaz. vod. kamene. Materiál Mosaz.
- Ruční sprcha, proti usaz. vod. kamene.
- Flexi hadice SATIN.

DŮLEŽITÉ: Použijte odtokovou trubici pro průtok >50 l/min.



20735301

1.705,00

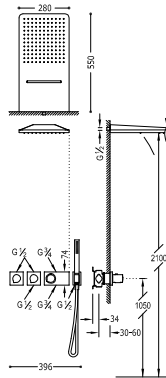

Concealed thermostatic shower kit BLOCK SYSTEM
with water shut off and flow control (3 ways).
• Built-in thermostatic body included.
• Stainless steel wall shower with 2 jet types 280x550 mm.
• Anti-limescale hand shower.
• Shower hose SATIN.
IMPORTANT: Assemble a drain of >50 l/min.

Kit doccia termostatica ad incasso BLOCK SYSTEM
Con chiusura e regolazione di portata (3 vie).
• Corpo incassato termostatico incluso.

• Doccia acciaio inossidabile da parete con 2 tipi di getto 280x550 mm.
• Doccetta anticalcare.
• Flessibile satin.

IMPORTANTE: Montare uno scarico di >50 l/min.

Termostatický podomítkový sprchový set BLOCK SYSTEM

s uzavěrem a regulací průtoku (3-cestná).
• Včetně podomítkového termostatického tělesa.
• Nástěnné sprchové křepítko z nerez. oceli s 2 typů proudění vody 280x550 mm.

• Ruční sprcha, proti usaz. vod. kamene.

• Flexi hadice SATIN.

DŮLEŽITÉ: Použijte odtokovou trubici pro průtok >50 l/min.

29916401
29916401NM
29916401BM
29916401AC

20735302 1.523,00

20735302NM 2.514,00

20735302BM 2.514,00

20735302AC 2.514,00

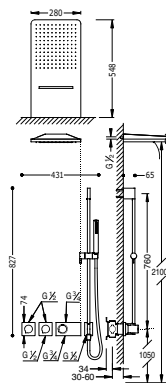

Concealed thermostatic shower kit BLOCK SYSTEM
with water shut off and flow control (3 ways).
• Built-in thermostatic body included.
• Stainless steel wall shower with 2 jet types 280x550 mm.
• Sliding bar with wall water intake. Length: 760 mm.
• Anti-limescale hand shower.
• Shower hose SATIN.
IMPORTANT: Assemble a drain of >50 l/min.

Kit doccia termostatica ad incasso BLOCK SYSTEM
Con chiusura e regolazione di portata (3 vie).
• Corpo incassato termostatico incluso.

• Doccia acciaio inossidabile da parete con 2 tipi di getto 280x550 mm.
• Barra di scorrimento con presa d'acqua a parete. Lung. 760 mm
• Doccetta anticalcare.
• Flessibile satin.

IMPORTANTE: Montare uno scarico di >50 l/min.

Termostatický podomítkový sprchový set BLOCK SYSTEM

s uzavěrem a regulací průtoku (3-cestná).
• Včetně podomítkového termostatického tělesa.
• Nástěnné sprchové křepítko z nerez. oceli s 2 typů proudění vody 280x550 mm.

• Posuvný tyč s nástěnným přívodem vody. Délka 760 mm.

• Ruční sprcha, proti usaz. vod. kamene.

• Flexi hadice SATIN.

DŮLEŽITÉ: Použijte odtokovou trubici pro průtok >50 l/min.

29916401
29916401NM
29916401BM
29916401AC

20735309 1.619,00

20735309NM 2.672,00

20735309BM 2.672,00

20735309AC 2.672,00



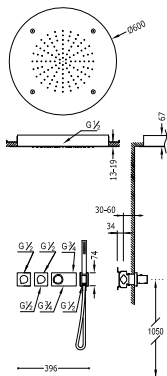

Concealed thermostatic shower kit BLOCK SYSTEM

- with water shut off and flow control (3 ways).
- Built-in thermostatic body included.
- Stainless steel ceiling shower with 2 jet types Ø 600 mm.
- Anti-limescale hand shower.
- Shower hose SATIN.

IMPORTANT: Assemble a drain of >50 l/min.

Kit doccia termostatica ad incasso BLOCK SYSTEM

- Con chiusura e regolazione di portata (3 vie).
- Corpo incassato termostatico incluso.
- Soffione doccia acciaio inossidabile con 2 tipi di getto Ø 600 mm.
- Doccetta anticalcare.
- Flessibile satin.

IMPORTANTE: Montare uno scarico di >50 l/min.

Termostatický podomítkový sprchový set BLOCK SYSTEM

- s uzávěrem a regulací průtoku (3-cestná).
- Včetně podomítkového termostatického tělesa.
- Stropní sprchové křepítko z nerez. oceli s 2 typů proudění vody Ø 600 mm.
- Ruční sprcha, proti usaz. vod. kamene.
- Flexi hadice SATIN.

DŮLEŽITÉ: Použijte odtokovou trubici pro průtok >50 l/min.

29916401



20735310

1.895,00

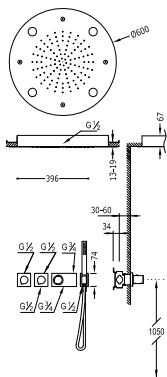

Concealed thermostatic shower kit BLOCK SYSTEM

CHROMOTHERAPY

- with water shut off and flow control (3 ways).
- Built-in thermostatic body included.
- Stainless steel ceiling shower with 2 jet types Ø 600 mm.
- Anti-limescale hand shower.
- Shower hose SATIN.

IMPORTANT: Assemble a drain of >50 l/min.

Kit doccia termostatica ad incasso BLOCK SYSTEM

- CHROMOTHERAPY
- Con chiusura e regolazione di portata (3 vie).
- Corpo incassato termostatico incluso.
- Soffione doccia acciaio inossidabile con 2 tipi di getto Ø 600 mm.
- Doccetta anticalcare.
- Flessibile satin.

IMPORTANTE: Montare uno scarico di >50 l/min.

Termostatický podomítkový sprchový set BLOCK SYSTEM

- CHROMOTHERAPY
- s uzávěrem a regulací průtoku (3-cestná).
- Včetně podomítkového termostatického tělesa.
- Stropní sprchové křepítko z nerez. oceli s 2 typů proudění vody Ø 600 mm.
- Ruční sprcha, proti usaz. vod. kamene.
- Flexi hadice SATIN.

DŮLEŽITÉ: Použijte odtokovou trubici pro průtok >50 l/min.

29916401



20735312

2.583,00



Concealed thermostatic shower kit BLOCK SYSTEM

- with water shut off and flow control (3 ways).
- Built-in thermostatic body included.
- Stainless steel ceiling shower with 2 jet types Ø 600 mm.
- Sliding bar with wall water intake. Length: 760 mm.
- Anti-limescale hand shower.
- Shower hose SATIN.

IMPORTANT: Assemble a drain of >50 l/min.

Kit doccia termostatica ad incasso BLOCK SYSTEM

- Con chiusura e regolazione di portata (3 vie).
- Corpo incassato termostatico incluso.
- Soffione doccia acciaio inossidabile con 2 tipi di getto Ø 600 mm.
- Barra di scorrimento con presa d'acqua a parete. Lung. 760 mm
- Doccetta anticalcare.
- Flessibile satin.

IMPORTANTE: Montare uno scarico di >50 l/min.

Termostatický podomítkový sprchový set BLOCK SYSTEM

- s uzávěrem a regulací průtoku (3-cestná).
- Včetně podomítkového termostatického tělesa.
- Stropní sprchové křepítka z nerez. oceli s 2 typů proudění vody Ø 600 mm.
- Posuvná tyč s nástěnným přívodem vody. Délka 760 mm.
- Ruční sprcha, proti usaz. vod. kamene.
- Flexi hadice SATIN.

DŮLEŽITÉ: Použijte odtokovou trubici pro průtok >50 l/min.

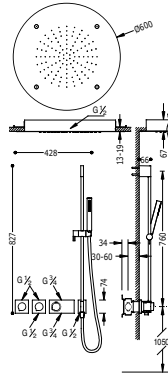

29916401



20735311

1.990,00



Concealed thermostatic shower kit BLOCK SYSTEM

- with water shut off and flow control (3 ways).
- Built-in thermostatic body included.
- Stainless steel ceiling shower with 2 jet types 500x500 mm.
- Anti-limescale hand shower.
- Shower hose SATIN.

IMPORTANT: Assemble a drain of >50 l/min.

Kit doccia termostatica ad incasso BLOCK SYSTEM

- Con chiusura e regolazione di portata (3 vie).
- Corpo incassato termostatico incluso.
- Soffione doccia acciaio inossidabile con 2 tipi di getto 500x500 mm.
- Doccetta anticalcare.
- Flessibile satin.

IMPORTANTE: Montare uno scarico di >50 l/min.

Termostatický podomítkový sprchový set BLOCK SYSTEM

- s uzávěrem a regulací průtoku (3-cestná).
- Včetně podomítkového termostatického tělesa.
- Stropní sprchové křepítka z nerez. oceli s 2 typů proudění vody 500x500 mm.
- Ruční sprcha, proti usaz. vod. kamene.
- Flexi hadice SATIN.

DŮLEŽITÉ: Použijte odtokovou trubici pro průtok >50 l/min.

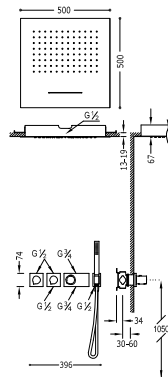

29916401



20735303

1.624,00



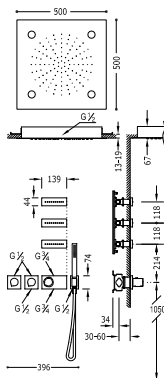

Concealed thermostatic shower kit BLOCK SYSTEM CHROMOTHERAPY

with water shut off and flow control (3 ways).

- Built-in thermostatic body included.
- Stainless steel ceiling shower 500x500 mm.
- 3 Anti-limescale jets. Brass.
- Anti-limescale hand shower.
- Shower hose SATIN.

IMPORTANT: Assemble a drain of >50 l/min.

Kit doccia termostatica ad incasso BLOCK SYSTEM CHROMOTHERAPY

Con chiusura e regolazione di portata (3 vie).

- Corpo incassato termostatico incluso.
- Soffione doccia acciaio inossidabile 500x500 mm.
- 3 jets anticalcare. Ottone.
- Doccetta anticalcare.
- Flessibile satin.

IMPORTANTE: Montare uno scarico di >50 l/min.

Termostatický podomítkový sprchový set BLOCK SYSTEM CHROMOTHERAPY

s uzávěrem a regulací průtoku (3-cestná).

- Včetně podomítkového termostatického tělesa.
- Stropní sprchové křepítko z nerez. oceli 500x500 mm.
- 3 natáčecí trysky, proti usaz. vod. kamene. Materiál Mosaz.
- Ruční sprcha, proti usaz. vod. kamene.
- Flexi hadice SATIN.

DŮLEŽITÉ: Použijte odtokovou trubici pro průtok >50 l/min.



20735304

2.469,00

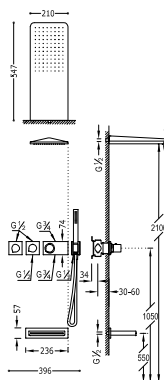

Concealed thermostatic bath kit BLOCK SYSTEM

with water shut off and flow control (3 ways).

- Built-in thermostatic body included.
- Stainless steel wall shower 210x550 mm.
- Steel cascade cast spout.
- Anti-limescale hand shower.
- Shower hose SATIN.

IMPORTANT: Assemble a drain of >50 l/min.

Kit termostatico vasca ad incasso BLOCK SYSTEM

Con chiusura e regolazione di portata (3 vie).

- Corpo incassato termostatico incluso.
- Doccia acciaio inossidabile da parete 210x550 mm.
- Tubo cascata vasca acciaio inossidabile.
- Doccetta anticalcare.
- Flessibile satin.

IMPORTANTE: Montare uno scarico di >50 l/min.

Termostatický podomítkový vanový set BLOCK SYSTEM

s uzávěrem a regulací průtoku (3-cestná).

- Včetně podomítkového termostatického tělesa.
- Nástěnné sprchové křepítko z nerez. oceli 210x550 mm.
- Vanové ramínko s kaskádou z nerez. oceli.
- Ruční sprcha, proti usaz. vod. kamene.
- Flexi hadice SATIN.

DŮLEŽITÉ: Použijte odtokovou trubici pro průtok >50 l/min.



20735305

1.570,00

Concealed thermostatic bath kit BLOCK SYSTEM

- with water shut off and flow control (3 ways).
- Built-in thermostatic body included.
- Fixed shower head Ø 300 mm. with ball joint. Brass.
- Steel cascade cast spout.
- Anti-limescale hand shower.
- Shower hose SATIN.

IMPORTANT: Assemble a drain of >50 l/min.

Kit termostatico vasca ad incasso BLOCK SYSTEM

Con chiusura e regolazione di portata (3 vie).

- Corpo incassato termostatico incluso.
- Doccia fissa Ø 300 mm. con snodo. Ottone.
- Tubo cascata vasca acciaio inossidabile.
- Doccetta anticalcare.
- Flessibile satin.

IMPORTANTE: Montare uno scarico di >50 l/min.

Termostatický podomítkový vanový set BLOCK SYSTEM

s uzávěrem a regulací průtoku (3-cestná).

- Včetně podomítkového termostatického tělesa.
- Pevná sprcha Ø 300 mm. s kloubem. Materiál Mosaz.
- Vanové ramínko s haskádaou z nerez. Oceli.
- Ruční sprcha, proti usaz. vod. kamene.
- Flexi hadice SATIN.

DŮLEŽITÉ: Použijte odtokovou trubici pro průtok >50 l/min.

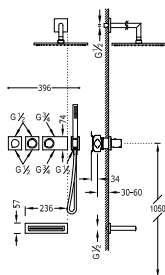

■ 20735308 1.334,00

■ 20735308AC 2.201,00





Concealed thermostatic bath kit BLOCK SYSTEM CHROMOTHERAPY

with water shut off and flow control (3 ways).

- Built-in thermostatic body included.
- Stainless steel ceiling shower 500x500 mm.
- Steel cascade cast spout.
- Anti-limescale hand shower.
- Shower hose SATIN.

IMPORTANT: Assemble a drain of >50 l/min.

Kit termostatico vasca ad incasso BLOCK SYSTEM CHROMOTHERAPY

Con chiusura e regolazione di portata (3 vie).

- Corpo incassato termostatico incluso.
- Soffione doccia acciaio inossidabile 500x500 mm.
- Tubo cascata vasca acciaio inossidabile.
- Doccetta anticalcare.
- Flessibile satin.

IMPORTANTE: Montare uno scarico di >50 l/min.

Termostatický podomítkový vanový set BLOCK SYSTEM CHROMOTHERAPY

s uzávěrem a regulací průtoku (3-cestná).

- Včetně podomítkového termostatického tělesa.
- Stropní sprchové křepítko z nerez. oceli 500x500 mm.
- Vanové ramínko s kaskádou z nerez. oceli.
- Ruční sprcha, proti usaz. vod. kamene.
- Flexi hadice SATIN.

DŮLEŽITÉ: Použijte odtokovou trubici pro průtok >50 l/min.

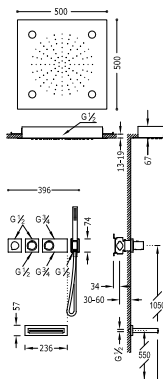

20735307

2.334,00

Recommended installation
Installazione consigliata
Doporučená instalace

This is the installation scheme recommended to enjoy the tap functions to the full.

Questo è uno schema dell'installazione consigliata per ottimizzare le funzioni del rubinetto.

Zde je doporučené schéma pro instalaci, pro zajištění maximálního využití funkcí baterie.

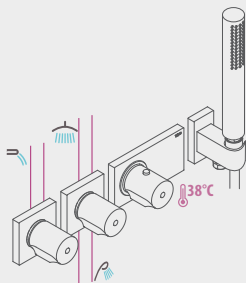

20735307



Concealed thermostatic bath kit BLOCK SYSTEM

- with water shut off and flow control (3 ways).
- Built-in thermostatic body included.
- Stainless steel ceiling shower Ø 380 mm.
- Steel cascade cast spout.
- Anti-limescale hand shower.
- Shower hose SATIN.

IMPORTANT: Assemble a drain of >50 l/min.

Kit termostatico vasca ad incasso BLOCK SYSTEM

Con chiusura e regolazione di portata (3 vie).

- Corpo incassato termostatico incluso.
- Soffione doccia acciaio inossidabile Ø 380 mm.
- Tubo cascata vasca acciaio inossidabile.
- Doccetta anticalcare.
- Flessibile satin.

IMPORTANTE: Montare uno scarico di >50 l/min.

Termostatický podomítkový vanový set BLOCK SYSTEM

s uzávěrem a regulací průtoku (3-cestná).

- Včetně podomítkového termostatického tělesa.
- Stropní sprchové hroptítko z nerez. oceli Ø 380 mm.
- Vanové ramínko s kaskádou z nerez. oceli.
- Ruční sprcha, proti usaz. vod. kamene.
- Flexi hadice SATIN.

DŮLEŽITÉ: Použijte odtokovou trubici pro průtok >50 l/min.

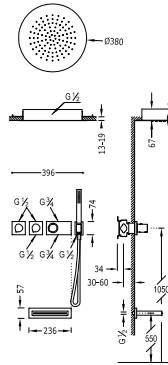

20735306

1.748,00



Concealed thermostatic mixer BLOCK SYSTEM

- with water shut off and flow control (4 ways).
- Built-in thermostatic body included.
- Anti-limescale hand shower.
- Shower hose SATIN.

299250A5	29925045AC	
29925045NM	29925045OR	
29925045BM	29925045GM	

Termostatica ad incasso BLOCK SYSTEM

- Con chiusura e regolazione di portata (4 vie).
- Corpo incassato termostatico incluso.
- Doccetta anticalcare.
- Flessibile satin.

Termostatická podomítková baterie BLOCK SYSTEM

- s uzávěrem a regulací průtoku (4-cestná).
- Včetně podomítkového termostatického tělesa.
- Ruční sprcha, proti usaz. vod. kamene.
- Flexi hadice SATIN.

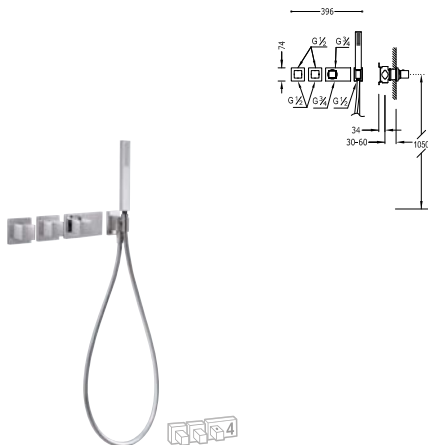

	20725491	859,00
	20725491NM	1.418,00
	20725491BM	1.418,00
	20725491AC	1.418,00
	20725491OR	1.718,00
	20725491GM	1.718,00



Concealed thermostatic mixer BLOCK SYSTEM

- with water shut off and flow control (4 ways).
- Built-in thermostatic body included.
- Sliding bar with wall water intake. Length: 760 mm.
- Anti-limescale hand shower.
- Shower hose SATIN.

299250A5	
----------	--

Termostatica ad incasso BLOCK SYSTEM

- Con chiusura e regolazione di portata (4 vie).
- Corpo incassato termostatico incluso.
- Barra di scorrimento con presa d'acqua a parete. Lung. 760 mm.
- Doccetta anticalcare.
- Flessibile satin.

Termostatická podomítková baterie BLOCK SYSTEM

- s uzávěrem a regulací průtoku (4-cestná).
- Včetně podomítkového termostatického tělesa.
- Posuvná tyč s nástěnným přívodem vody. Délka 760 mm.
- Ruční sprcha, proti usaz. vod. kamene.
- Flexi hadice SATIN.

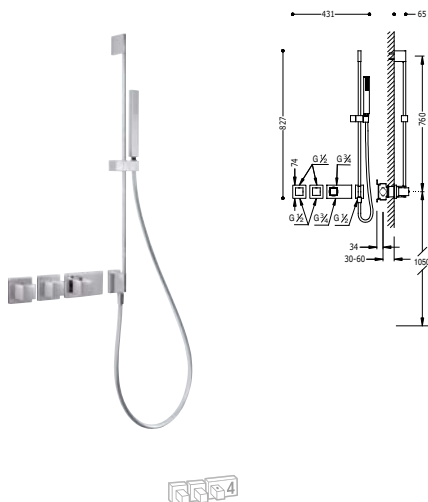

	20725492	965,00
--	----------	---------------



Concealed thermostatic mixer BLOCK SYSTEM

- with water shut off and flow control (4 ways).**
- Built-in thermostatic body included.
 - Anti-limescale hand shower.
 - Shower hose SATIN.

Termostatica ad incasso BLOCK SYSTEM

- Con chiusura e regolazione di portata (4 vie).
- Corpo incassato termostatico incluso.
 - Doccetta anticalcare.
 - Flessibile satin.

Termostatická podomítková baterie BLOCK SYSTEM

- s uzávěrem a regulací průtoku (4-cestná).
- Včetně podomítkového termostatického tělesa.
 - Ruční sprcha, proti usaz. vod. kamene.
 - Flexi hadice SATIN.

29916401	29916401AC	
29916401NM	29916401OR	
29916401BM	29916401OM	

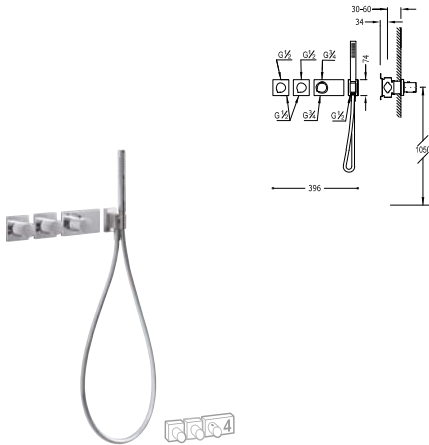

	20735491	849,00
	M 20735491NM	1.401,00
	M 20735491BM	1.401,00
	20735491C	1.401,00
	Z 20735491OR	1.697,00
	Z 20735491OM	1.697,00



Concealed thermostatic mixer BLOCK SYSTEM

- with water shut off and flow control (4 ways).**
- Built-in thermostatic body included.
 - Sliding bar with wall water intake. Length: 760 mm.
 - Anti-limescale hand shower.
 - Shower hose SATIN.

Termostatica ad incasso BLOCK SYSTEM

- Con chiusura e regolazione di portata (4 vie).
- Corpo incassato termostatico incluso.
 - Barra di scorrimento con presa d'acqua a parete. Lung. 760 mm.
 - Doccetta anticalcare.
 - Flessibile satin.

Termostatická podomítková baterie BLOCK SYSTEM

- s uzávěrem a regulací průtoku (4-cestná).
- Včetně podomítkového termostatického tělesa.
 - Posuvná tyč s nástěnným přívodem vody. Délka 760 mm.
 - Ruční sprcha, proti usaz. vod. kamene.
 - Flexi hadice SATIN.

29916401	
----------	--

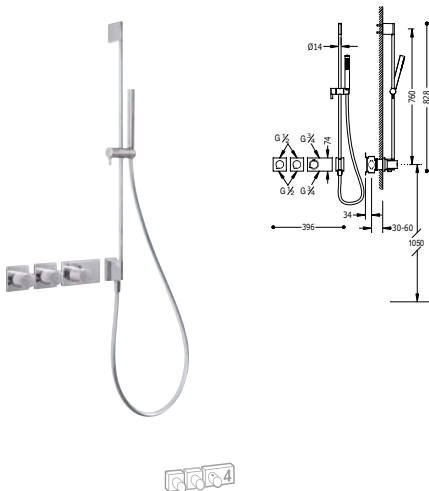

	20735492	955,00
--	----------	---------------



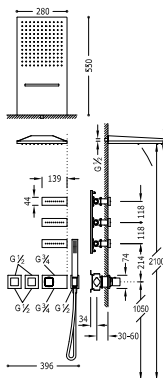

Concealed thermostatic shower kit BLOCK SYSTEM

- with water shut off and flow control (3 ways).
- Built-in thermostatic body included.
- Stainless steel wall shower with 2 jet types 280x550 mm.
- 3 Anti-limescale jets. Brass.
- Anti-limescale hand shower.
- Shower hose SATIN.

IMPORTANT: Assemble a drain of >50 l/min.

Kit doccia termostatica ad incasso BLOCK SYSTEM
Con chiusura e regolazione di portata (4 vie).

- Corpo incassato termostatico incluso.
- Doccia acciaio inossidabile da parete con 2 tipi di getto 280x550 mm.
- 3 jets anticalcare. Ottone.
- Doccetta anticalcare.
- Flessibile satin.

IMPORTANTE: Montare uno scarico di >50 l/min.

Termostatický podomítkový sprchový set BLOCK SYSTEM
s uzávěrem a regulací průtoku (4-cestná).

- Včetně podomítkového termostatického tělesa.
- Nástěnné sprchové křepitko z nerez. oceli s 2 typů proudění vody 280x550 mm.
- 3 natáčecí trysky, proti usaz. vod. kamene. Materiál Mosaz.
- Ruční sprcha, proti usaz. vod. kamene.
- Flexi hadice SATIN.

DŮLEŽITÉ: Použijte odtokovou trubici pro průtok >50 l/min.



20725401

1.937,00

Recommended installation Installazione consigliata Doporučená instalace

This is the installation scheme recommended to enjoy the tap functions to the full.

Questo è uno schema dell'installazione consigliata per ottimizzare le funzioni del rubinetto.

Zde je doporučené schéma pro instalaci, pro zajištění maximálního využití funkcí baterie.

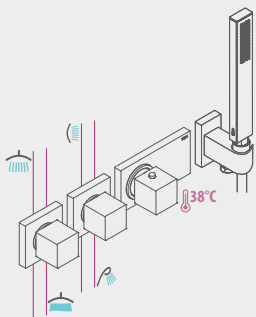

20725401



29925045 

Concealed thermostatic shower kit BLOCK SYSTEM

- with water shut off and flow control (4 ways).
- Built-in thermostatic body included.
- Stainless steel ceiling shower with 2 jet types 500x500 mm.
- 3 Anti-limescale jets. Brass.
- Anti-limescale hand shower.
- Shower hose SATIN.

IMPORTANT: Assemble a drain of >50 l/min.

Kit doccia termostatica ad incasso BLOCK SYSTEM

- Con chiusura e regolazione di portata (4 vie).
- Corpo incassato termostatico incluso.
- Soffione doccia acciaio inossidabile con 2 tipi di getto 500x500 mm.
- 3 Jets anticalcare. Ottone.
- Doccetta anticalcare.
- Flessibile satin.

IMPORTANTE: Montare uno scarico di >50 l/min.

Termostatický podomítkový sprchový set BLOCK SYSTEM

- s uzávěrem a regulací průtoku (4-cestná).
- Včetně podomítkového termostatického tělesa.
- Stropní sprchové křepítka z nerez. oceli s 2 typů proudění vody 500x500 mm.
- 3 natáčecí trysky, proti usaz. vod. kamene. Materiál Mosaz.
- Ruční sprcha, proti usaz. vod. kamene.
- Flexi hadice SATIN.

DŮLEŽITÉ: Použijte odtokovou trubici pro průtok >50 l/min.

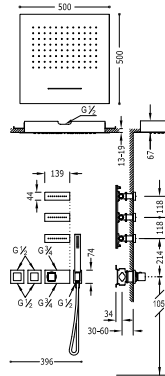

 20725402

2.099,00

Concealed thermostatic shower kit BLOCK SYSTEM

- with water shut off and flow control (4 ways).
- Built-in thermostatic body included.
- Stainless steel ceiling shower with 2 jet types 500x800 mm.
- Anti-limescale hand shower.
- Shower hose SATIN.

IMPORTANT: Assemble a drain of >50 l/min.

Kit doccia termostatica ad incasso BLOCK SYSTEM

- Con chiusura e regolazione di portata (4 vie).
- Corpo incassato termostatico incluso.
- Soffione doccia acciaio inossidabile con 2 tipi di getto 500x800 mm.
- Doccetta anticalcare.
- Flessibile satin.

IMPORTANTE: Montare uno scarico di >50 l/min.

Termostatický podomítkový sprchový set BLOCK SYSTEM

- s uzávěrem a regulací průtoku (4-cestná).
- Včetně podomítkového termostatického tělesa.
- Stropní sprchové křepítka z nerez. oceli s 2 typů proudění vody 500x800 mm.
- Ruční sprcha, proti usaz. vod. kamene.
- Flexi hadice SATIN.

DŮLEŽITÉ: Použijte odtokovou trubici pro průtok >50 l/min.

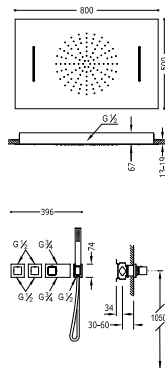

 20725403

2.219,00

BLOCK SYSTEM



Concealed thermostatic shower kit BLOCK SYSTEM CHROMOTHERAPY

29925045



- with water shut off and flow control (4 ways).
 - Built-in thermostatic body included.
 - Stainless steel ceiling shower with 2 jet types 500x800 mm.
 - Anti-limescale hand shower.
 - Shower hose SATIN.
- IMPORTANT:** Assemble a drain of >50 l/min.

Kit doccia termostatica ad incasso BLOCK SYSTEM CHROMOTHERAPY

- Con chiusura e regolazione di portata (4 vie).
- Corpo incassato termostatico incluso.
- Soffione doccia acciaio inossidabile con 2 tipi di getto 500x800 mm.
- Doccetta anticalcare.
- Flessibile satin.

IMPORTANTE: Montare uno scarico di >50 l/min.

Termostatický podomítkový sprchový set BLOCK SYSTEM CHROMOTHERAPY

- s uzávěrem a regulací průtoku (4-cestná).
 - Včetně podomítkového termostatického tělesa.
 - Stropní sprchové křepítko z nerez. oceli s 2 typů proudění vody 500x800 mm.
 - Ruční sprcha, proti usaz. vod. kamene.
 - Flexi hadice SATIN.
- DŮLEŽITÉ:** Použijte odtokovou trubici pro průtok >50 l/min.

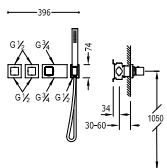
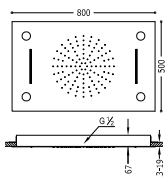

20725404

2.691,00



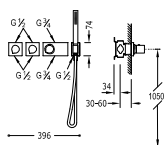
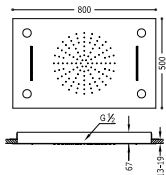

Concealed thermostatic shower kit BLOCK SYSTEM CHROMOTHERAPY

- with water shut off and flow control (4 ways).
- Built-in thermostatic body included.
- Stainless steel ceiling shower with 2 jet types 500x800 mm.
- Anti-limescale hand shower.
- Shower hose SATIN.

IMPORTANT: Assemble a drain of >50 l/min.

Kit doccia termostatica ad incasso BLOCK SYSTEM CHROMOTHERAPY

- Con chiusura e regolazione di portata (4 vie).
- Corpo incassato termostatico incluso.
- Soffione doccia acciaio inossidabile con 2 tipi di getto 500x800 mm.
- Doccetta anticalcare.
- Flessibile satin.

IMPORTANTE: Montare uno scarico di >50 l/min.

Termostatický podomítkový sprchový set BLOCK SYSTEM CHROMOTHERAPY

- s uzávěrem a regulací průtoku (4-cestná).
- Včetně podomítkového termostatického tělesa.
- Stropní sprchové křepítko z nerez. oceli s 2 typů proudění vody 500x800 mm.
- Ruční sprcha, proti usaz. vod. kamene.
- Flexi hadice SATIN.

DŮLEŽITÉ: Použijte odtokovou trubici pro průtok >50 l/min.

29916401



20735404

2.682,00

Recommended installation Installazione consigliata Doporučená instalace

This is the installation scheme recommended to enjoy the tap functions to the full.

Questo è uno schema dell'installazione consigliata per ottimizzare le funzioni del rubinetto.

Zde je doporučené schéma pro instalaci, pro zajištění maximálního využití funkcí baterie.

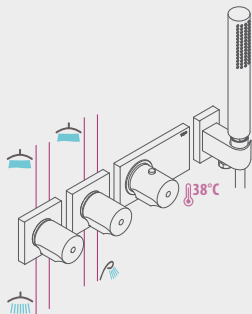

20735404





Concealed thermostatic shower kit BLOCK SYSTEM

- with water shut off and flow control (4 ways).
- Built-in thermostatic body included.
- Stainless steel ceiling shower with 2 jet types 500x500 mm.
- 3 Anti-limescale jets. Brass.
- Anti-limescale hand shower.
- Shower hose SATIN.

IMPORTANT: Assemble a drain of >50 l/min.

Kit doccia termostatica ad incasso BLOCK SYSTEM

- Con chiusura e regolazione di portata (4 vie).
- Corpo incassato termostatico incluso.
- Soffione doccia acciaio inossidabile con 2 tipi di getto 500x500 mm.
- 3 jets anticalcare. Ottone.
- Doccetta anticalcare.
- Flessibile satin.

IMPORTANTE: Montare uno scarico di >50 l/min.

Termostatický podomítkový sprchový set BLOCK SYSTEM

- s uzávěrem a regulací průtoku (4-cestná).
- Včetně podomítkového termostatického tělesa.
- Stropní sprchové kropítko z nerez. oceli s 2 typů proudění vody 500x500 mm.
- 3 natáčecí trysky, proti usaz. vod. kamene. Materiál Mosaz.
- Ruční sprcha, proti usaz. vod. kamene.
- Flexi hadice SATIN.

DŮLEŽITÉ: Použijte odtokovou trubici pro průtok >50 l/min.

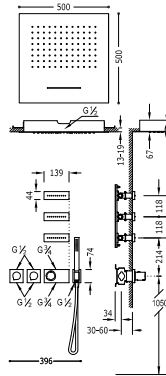

20735402

2.090,00



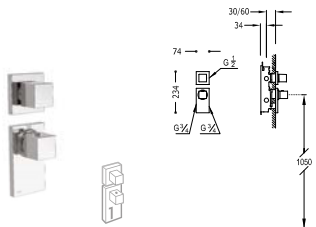

Concealed thermostatic mixer BLOCK SYSTEM
with water shut off and flow control (1 way).
• Built-in thermostatic body included.

Termostatica ad incasso BLOCK SYSTEM
Con chiusura e regolazione di portata (1 via).
• Corpo incassato termostatico incluso.

Termostatická podomítková baterie BLOCK SYSTEM
s uzávěrem a regulací průtoku (1-cestná).
• Včetně podomítkového termostatického tělesa.



29925045	29925045AC	
29925045NM	29925045OR	
29925045BM	29925045OM	

20625199	536,00
M 20625199NM	884,00
M 20625199BM	884,00
M 20625199AC	884,00
24 20625199OR	1.071,00
24 20625199OM	1.071,00

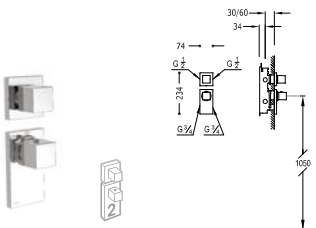

Concealed thermostatic mixer BLOCK SYSTEM
with water shut off and flow control (2 ways).
• Built-in thermostatic body included.

Termostatica ad incasso BLOCK SYSTEM
Con chiusura e regolazione di portata (2 vie).
• Corpo incassato termostatico incluso.

Termostatická podomítková baterie BLOCK SYSTEM
s uzávěrem a regulací průtoku (2-cestná).
• Včetně podomítkového termostatického tělesa.



29925045	29925045AC	
29925045NM	29925045OR	
29925045BM	29925045OM	

20625299	536,00
M 20625299NM	884,00
M 20625299BM	884,00
M 20625299AC	884,00
24 20625299OR	1.071,00
24 20625299OM	1.071,00

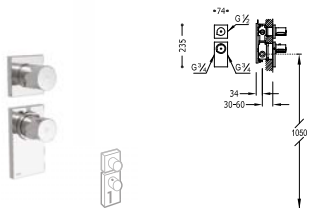

Concealed thermostatic mixer BLOCK SYSTEM
with water shut off and flow control (1 way).
• Built-in thermostatic body included.

Termostatica ad incasso BLOCK SYSTEM
Con chiusura e regolazione di portata (1 via).
• Corpo incassato termostatico incluso.

Termostatická podomítková baterie BLOCK SYSTEM
s uzávěrem a regulací průtoku (1-cestná).
• Včetně podomítkového termostatického tělesa.



29916401	29916401AC	
29916401NM	29916401OR	
29916401BM	29916401OM	

20635199	525,00
M 20635199NM	867,00
M 20635199BM	867,00
M 20635199AC	867,00
24 20635199OR	1.051,00
24 20635199OM	1.051,00

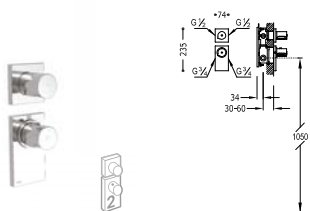

Concealed thermostatic mixer BLOCK SYSTEM
with water shut off and flow control (2 ways).
- Built-in thermostatic body included.

Termostatica ad incasso BLOCK SYSTEM
Con chiusura e regolazione di portata (2 vie).
- Corpo incassato termostatico incluso.

Termostatická podomítková baterie BLOCK SYSTEM
s uzávěrem a regulací průtoku (2-cestná).
- Včetně podomítkového termostatického tělesa.



29916401	29916401AC	
29916401NM	29916401OR	
29916401BM	29916401OM	

20635299 525,00

20635299NM 867,00

20635299BM 867,00

20635299AC 867,00

20635299OR 1.051,00

20635299OM 1.051,00

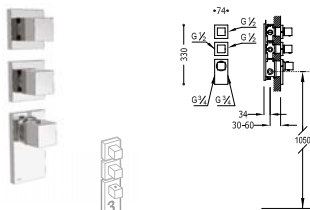

Concealed thermostatic mixer BLOCK SYSTEM
with water shut off and flow control (3 ways).
- Built-in thermostatic body included.

Termostatica ad incasso BLOCK SYSTEM
Con chiusura e regolazione di portata (3 vie).
- Corpo incassato termostatico incluso.

Termostatická podomítková baterie BLOCK SYSTEM
s uzávěrem a regulací průtoku (3-cestná).
- Včetně podomítkového termostatického tělesa.



29925045	29925045AC	
29925045NM	29925045OR	
29925045BM	29925045OM	

20625399 706,00

20625399NM 1.165,00

20625399BM 1.165,00

20625399AC 1.165,00

20625399OR 1.411,00

20625399OM 1.411,00

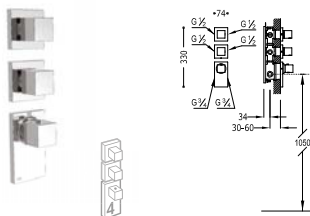

Concealed thermostatic mixer BLOCK SYSTEM
with water shut off and flow control (4 ways).
- Built-in thermostatic body included.

Termostatica ad incasso BLOCK SYSTEM
Con chiusura e regolazione di portata (4 vie).
- Corpo incassato termostatico incluso.

Termostatická podomítková baterie BLOCK SYSTEM
s uzávěrem a regulací průtoku (4-cestná).
- Včetně podomítkového termostatického tělesa.



29925045	29925045AC	
29925045NM	29925045OR	
29925045BM	29925045OM	

20625499 706,00

20625499NM 1.165,00

20625499BM 1.165,00

20625499AC 1.165,00

20625499OR 1.411,00

20625499OM 1.411,00

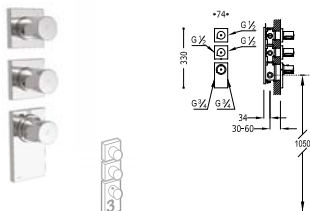

Concealed thermostatic mixer BLOCK SYSTEM
with water shut off and flow control (3 ways).
- Built-in thermostatic body included.

Termostatica ad incasso BLOCK SYSTEM
Con chiusura e regolazione di portata (3 vie).
- Corpo incassato termostatico incluso.

Termostatická podomítková baterie BLOCK SYSTEM
s uzávěrem a regulací průtoku (3-cestná).
- Včetně podomítkového termostatického tělesa.



29916401	29916401AC	
29916401NM	29916401OR	
29916401BM	29916401OM	

20635399 695,00

20635399NM 1.147,00

20635399BM 1.147,00

20635399AC 1.147,00

20635399OR 1.391,00

20635399OM 1.391,00

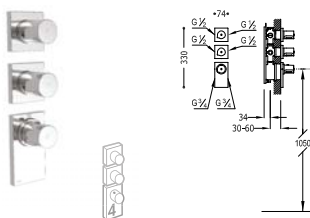

Concealed thermostatic mixer BLOCK SYSTEM
with water shut off and flow control (4 ways).
- Built-in thermostatic body included.

Termostatica ad incasso BLOCK SYSTEM
Con chiusura e regolazione di portata (4 vie).
- Corpo incassato termostatico incluso.

Termostatická podomítková baterie BLOCK SYSTEM
s uzávěrem a regulací průtoku (4-cestná).
- Včetně podomítkového termostatického tělesa.



29916401	29916401AC	
29916401NM	29916401OR	
29916401BM	29916401OM	

20635499 695,00

20635499NM 1.147,00

20635499BM 1.147,00

20635499AC 1.147,00

20635499OR 1.391,00

20635499OM 1.391,00

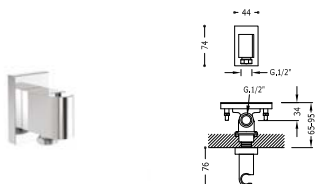

Shower holder BLOCK SYSTEM
with adjustable depth wall water inlet fitting and anti-return valve. Built-in body included.

Supporto per doccia BLOCK SYSTEM
con presa d'acqua a parete con profondità regolabile e valvola antiritorno. Corpo incassato incluso.

Úchyt ruční sprchy se stěnovou přípojkou vody BLOCK SYSTEM

s nastavitelným výstupem pro vodu a zpětným ventilem. Včetně podomítkového tělesa.

20718202 112,00

20718202NM 185,00

20718202BM 185,00

20718202AC 185,00

20718202OR 225,00

20718202OM 225,00

**Concealed thermostatic mixer
BLOCK SYSTEM**

with water shut off and flow control (1 way).

- Built-in thermostatic body included
- Anti-limescale hand shower.
- Shower hose SATIN.

29925045	29925045AC	
29925045NM	29925045OR	
29925045BM	29925045CM	

Termostatica ad incasso BLOCK SYSTEM

Con chiusura e regolazione di portata (1 via).

- Corpo incassato termostatico incluso
- Doccetta anticalcare.
- Flessibile satin.

Termostatická baterie podomítková BLOCK SYSTEM

s uzávěrem a regulací průtoku (1-cestně)

- Včetně podomítkového termostatického tělesa
- Ruční sprcha, proti usaz. vod. kamene.
- Flexi hadice SATIN.

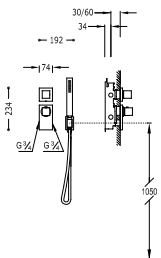

	20625191	666,00
	20625191NM	1.100,00
	20625191BM	1.100,00
	20625191AC	1.100,00
	20625191OR	1.333,00
	20625191CM	1.333,00



**Concealed thermostatic mixer
BLOCK SYSTEM**

with water shut off and flow control (1 way).

- Built-in thermostatic body included
- Anti-limescale hand shower.
- Shower hose SATIN.

29916401	29916401AC	
29916401NM	29916401OR	
29916401BM	29916401CM	

Termostatica ad incasso BLOCK SYSTEM

Con chiusura e regolazione di portata (1 via).

- Corpo incassato termostatico incluso
- Doccetta anticalcare.
- Flessibile satin.

Termostatická baterie podomítková BLOCK SYSTEM

s uzávěrem a regulací průtoku (1-cestně)

- Včetně podomítkového termostatického tělesa
- Ruční sprcha, proti usaz. vod. kamene.
- Flexi hadice SATIN.

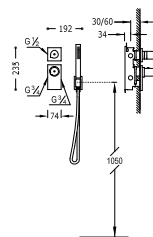

	20635191	679,00
	20635191NM	1.121,00
	20635191BM	1.121,00
	20635191AC	1.121,00
	20635191OR	1.358,00
	20635191CM	1.358,00



Concealed thermostatic mixer BLOCK SYSTEM

- with water shut off and flow control (2 ways).
 - Built-in thermostatic body included.
 - Anti-limescale hand shower.
 - Shower hose SATIN.

29925045	29925045AC	
29925045NM	29925045OR	
29925045BM	29925045OM	

Termostatica ad incasso BLOCK SYSTEM

- Con chiusura e regolazione di portata (2 vie).
 - Corpo incassato termostatico incluso.
 - Doccetta anticalcare.
 - Flessibile satin.

Termostatická podomítková baterie BLOCK SYSTEM

- s uzávěrem a regulací průtoku (2-cestná).
 - Včetně podomítkového termostatického tělesa.
 - Ruční sprcha, proti usaz. vod. kamene.
 - Flexi hadice SATIN.

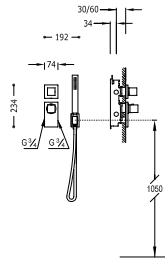

	20625291	666,00
	20625291NM	1.100,00
	20625291BM	1.100,00
	20625291AC	1.100,00
	20625291OR	1.333,00
	20625291OM	1.333,00



Concealed thermostatic mixer BLOCK SYSTEM

- with water shut off and flow control (2 ways).
 - Built-in thermostatic body included.
 - Anti-limescale hand shower.
 - Shower hose SATIN.

29916401	29916401AC	
29916401NM	29916401OR	
29916401BM	29916401OM	

Termostatica ad incasso BLOCK SYSTEM

- Con chiusura e regolazione di portata (2 vie).
 - Corpo incassato termostatico incluso.
 - Doccetta anticalcare.
 - Flessibile satin.

Termostatická podomítková baterie BLOCK SYSTEM

- s uzávěrem a regulací průtoku (2-cestná).
 - Včetně podomítkového termostatického tělesa.
 - Ruční sprcha, proti usaz. vod. kamene.
 - Flexi hadice SATIN.

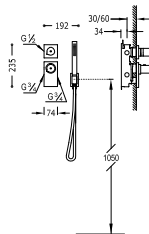

	20635291	679,00
	20635291NM	1.121,00
	20635291BM	1.121,00
	20635291AC	1.121,00
	20635291OR	1.358,00
	20635291OM	1.358,00



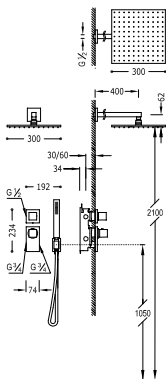

Concealed thermostatic shower kit BLOCK SYSTEM

- with water shut off and flow control (2 ways).
- Built-in thermostatic body included.
- Fixed shower head 300x300 mm. with ball joint. Brass.
- Anti-limescale hand shower.
- Shower hose SATIN.

Kit doccia termostatica ad incasso BLOCK SYSTEM

- Con chiusura e regolazione di portata (2 vie).
- Corpo incassato termostatico incluso.
- Doccia fissa 300x300 mm. con snodo. Ottone.
- Doccetta anticalcare.
- Flessibile satin.

Termostatický podomítkový sprchový set BLOCK SYSTEM

- s uzávěrem a regulací průtoku (2-cestná).
- Včetně podomítkového termostatického tělesa.
- Pevná sprcha 300x300 mm. s kloubem. Materiál mosaz.
- Ruční sprcha, proti usaz. vod. kamene.
- Flexi hadice SATIN.

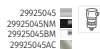

20625201 890,00

20625201NM 1.469,00

20625201BM 1.469,00

20625201AC 1.469,00

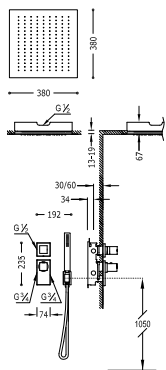

Concealed thermostatic shower kit BLOCK SYSTEM

- with water shut off and flow control (2 ways).
- Built-in thermostatic body included.
- Stainless steel ceiling shower 380x380 mm.
- Anti-limescale hand shower.
- Shower hose SATIN.

Kit doccia termostatica ad incasso BLOCK SYSTEM

- Con chiusura e regolazione di portata (2 vie).
- Corpo incassato termostatico incluso.
- soffione doccia acciaio inossidabile 380x380 mm.
- Doccetta anticalcare.
- Flessibile satin.

Termostatický podomítkový sprchový set BLOCK SYSTEM

- s uzávěrem a regulací průtoku (2-cestná).
- Včetně podomítkového termostatického tělesa.
- Stropní sprchové křepítko z nerez. oceli 380x380 mm.
- Ruční sprcha, proti usaz. vod. kamene.
- Flexi hadice SATIN.

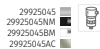

20625204 1.211,00

20625204NM 1.999,00

20625204BM 1.999,00

20625204AC 1.999,00



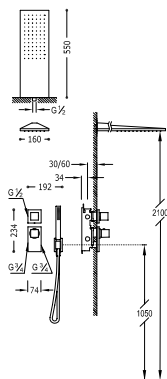

Concealed thermostatic shower kit BLOCK SYSTEM

with water shut off and flow control (2 ways).

- Built-in thermostatic body included.
- Stainless steel wall shower 160x550 mm.
- Anti-limescale hand shower.
- Shower hose SATIN.

Kit doccia termostatica ad incasso BLOCK SYSTEM

Con chiusura e regolazione di portata (2 vie).

- Corpo incassato termostatico incluso.
- Doccia acciaio inossidabile da parete 160x550 mm.
- Doccetta anticalcare.
- Flessibile satin.

Termostatický podomítkový sprchový set BLOCK SYSTEM

s uzávěrem a regulací průtoku (2-cestná).

- Včetně podomítkového termostatického tělesa.
- Nástěnné sprchové křepítka z nerez. oceli 160x550 mm.
- Ruční sprcha, proti usaz. vod. kamene.
- Flexi hadice SATIN.

29925045
29925045NM
29925045BM
29925045AC



20625202 976,00

20625202NM 1.612,00

20625202BM 1.612,00

20625202AC 1.612,00



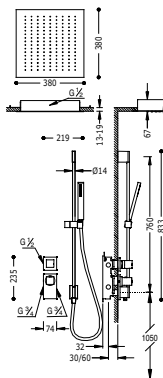

Concealed thermostatic shower kit BLOCK SYSTEM

with water shut off and flow control (2 ways).

- Built-in thermostatic body included.
- Stainless steel ceiling shower 380x380 mm.
- Sliding bar with wall water intake. Length: 760 mm.
- Anti-limescale hand shower.
- Shower hose SATIN.

29925045
29925045NM
29925045BM
29925045AC

Kit doccia termostatica ad incasso BLOCK SYSTEM

Con chiusura e regolazione di portata (2 vie).

- Corpo incassato termostatico incluso.
- Soffione doccia acciaio inossidabile 380x380 mm.
- Barra di scorrimento con presa d'acqua a parete. Lung. 760 mm.
- Doccetta anticalcare.
- Flessibile satin.

Termostatický podomítkový sprchový set BLOCK SYSTEM

s uzávěrem a regulací průtoku (2-cestná).

- Včetně podomítkového termostatického tělesa.
- Stropní sprchové křepitko z nerez. oceli 380x380 mm.
- Posuvná tyč s nástěnným přívodem vody. Délka 760 mm.
- Ruční sprcha, proti usaz. vod. kamene.
- Flexi hadice SATIN.

20625203 1.307,00

20625203NM 2.157,00

20625203BM 2.157,00

20625203AC 2.157,00

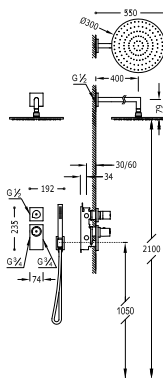

Concealed thermostatic shower kit BLOCK SYSTEM

with water shut off and flow control (2 ways).

- Built-in thermostatic body included.
- Fixed shower head Ø 300 mm. with ball joint. Brass.
- Anti-limescale hand shower.
- Shower hose SATIN.

29916401
29916401NM
29916401BM
29916401AC

Kit doccia termostatica ad incasso BLOCK SYSTEM

Con chiusura e regolazione di portata (2 vie).

- Corpo incassato termostatico incluso.
- Doccia fissa Ø 300 mm. con snodo. Ottone.
- Doccetta anticalcare.
- Flessibile satin.

Termostatický podomítkový sprchový set BLOCK SYSTEM

s uzávěrem a regulací průtoku (2-cestná).

- Včetně podomítkového termostatického tělesa.
- Pevná sprcha Ø 300 mm. s kloubem. Materiál Mosaz.
- Ruční sprcha, proti usaz. vod. kamene.
- Flexi hadice SATIN.

20635201 854,00

20635201NM 1.409,00

20635201BM 1.409,00

20635201AC 1.409,00

20635201KM 1.409,00





Concealed thermostatic shower kit BLOCK SYSTEM

- with water shut off and flow control (2 ways).
- Built-in thermostatic body included.
- Stainless steel wall shower 160x550 mm.
- Anti-limescale hand shower.
- Shower hose SATIN.



Kit doccia termostatica ad incasso BLOCK SYSTEM

- Con chiusura e regolazione di portata (2 vie).
- Corpo incassato termostatico incluso.
- Doccia acciaio inossidabile da parete 160x550 mm.
- Doccetta anticalcare.
- Flessibile satin.

Podomítkový termostatický sprchový set BLOCK SYSTEM

- s uzávěrem a regulací průtoku (2-cestná).
- Včetně podomítkového termostatického tělesa.
- Nástěnné sprchové křepitko z nerez. oceli 160x550 mm.
- Ruční sprcha, proti usaz. vod. kamene.
- Flexi hadice SATIN.

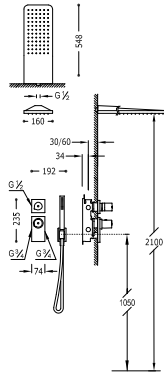

20635202 1.047,00

M 20635202NM 1.727,00

M 20635202BM 1.727,00

M 20635202AC 1.727,00



Concealed thermostatic shower kit BLOCK SYSTEM

- with water shut off and flow control (2 ways).
- Built-in thermostatic body included.
- Stainless steel ceiling shower Ø 380 mm.
- Anti-limescale hand shower.
- Shower hose SATIN.



Kit doccia termostatica ad incasso BLOCK SYSTEM

- Con chiusura e regolazione di portata (2 vie).
- Corpo incassato termostatico incluso.
- Soffione doccia acciaio inossidabile Ø 380 mm.
- Doccetta anticalcare.
- Flessibile satin.

Termostatický podomítkový sprchový set BLOCK SYSTEM

- s uzávěrem a regulací průtoku (2-cestná).
- Včetně podomítkového termostatického tělesa.
- Stropní sprchové křepitko z nerez. oceli Ø 380 mm.
- Ruční sprcha, proti usaz. vod. kamene.
- Flexi hadice SATIN.

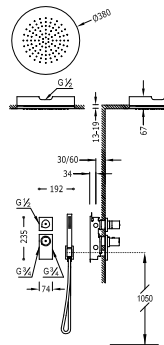

20635204 1.257,00

M 20635204NM 2.073,00

M 20635204BM 2.073,00

M 20635204AC 2.073,00



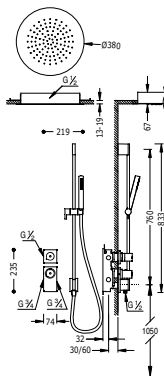

Concealed thermostatic shower kit BLOCK SYSTEM

with water shut off and flow control (2 ways).

- Built-in thermostatic body included.
- Stainless steel ceiling shower Ø 380 mm.
- Sliding bar with wall water intake. Length: 760 mm.
- Anti-limescale hand shower.
- Shower hose SATIN.

29916401
29916401NM
29916401BM
29916401AC

Kit doccia termostatica ad incasso BLOCK SYSTEM

Con chiusura e regolazione di portata (2 vie).

- Corpo incassato termostatico incluso.
- Soffione doccia acciaio inossidabile Ø 380 mm.
- Barra di scorrimento con presa d'acqua a parete. Lung. 760 mm.
- Doccetta anticalcare.
- Flessibile satin.

Termostatický podomítkový sprchový set BLOCK SYSTEM

s uzávěrem a regulací průtoku (2-cestná).

- Včetně podomítkového termostatického tělesa.
- Stropní sprchové křepitko z nerez. oceli Ø 380 mm.
- Posuvná tyč s nástěnným přívodem vody. Délka 760 mm.
- Ruční sprcha, proti usaz. vod. kamene.
- Flexi hadice SATIN.

20635203 1.351,00

20635203NM 2.230,00

20635203BM 2.230,00

20635203AC 2.230,00



Recommended installation Installazione consigliata Doporučená instalace

This is the installation scheme recommended to enjoy the tap functions to the full.

Questo è uno schema dell'installazione consigliata per ottimizzare le funzioni del rubinetto.

Zde je doporučené schéma pro instalaci, pro zajištění maximálního využití funkcí baterie.

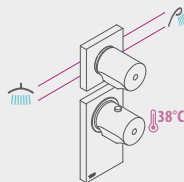

206.352.03 / 206.352.03.AC / 206.352.03.NM / 206.352.03.BM



Concealed thermostatic mixer BLOCK SYSTEM

- with water shut off and flow control (3 ways).**
- Built-in thermostatic body included
 - Anti-limescale hand shower.
 - Shower hose SATIN.

Termostatica ad incasso BLOCK SYSTEM

- Con chiusura e regolazione di portata (3 vie).
- Corpo incassato termostatico incluso
 - Doccetta anticalcare.
 - Flessibile satin.

Termostatická baterie podomítková BLOCK SYSTEM

- s uzávěrem a regulací průtoku (3-cestná)
- Včetně podomítkového termostatického tělesa
 - Ruční sprcha, proti usaz. vod. kamene.
 - Flexi hadice SATIN.

2992504S	29925045AC	
29925045NM	29925045OR	
29925045BM	29925045OM	

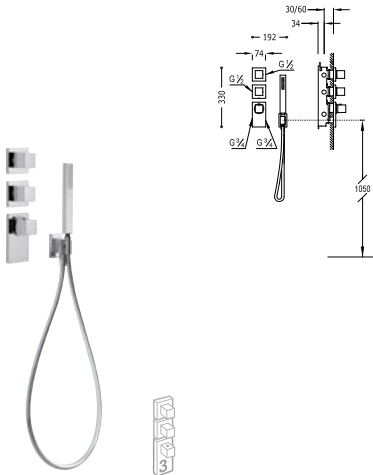

	20625391	859,00
	20625391NM	1.418,00
	20625391BM	1.418,00
	20625391AC	1.418,00
	20625391OR	1.718,00
	20625391OM	1.718,00



Concealed thermostatic mixer BLOCK SYSTEM

- with water shut off and flow control (3 ways).**
- Built-in thermostatic body included
 - Anti-limescale hand shower.
 - Shower hose SATIN.

Termostatica ad incasso BLOCK SYSTEM

- Con chiusura e regolazione di portata (3 vie).
- Corpo incassato termostatico incluso
 - Doccetta anticalcare.
 - Flessibile satin.

Termostatická baterie podomítková BLOCK SYSTEM

- s uzávěrem a regulací průtoku (3-cestná)
- Včetně podomítkového termostatického tělesa
 - Ruční sprcha, proti usaz. vod. kamene.
 - Flexi hadice SATIN.

29916401	29916401AC	
29916401NM	29916401OR	
29916401BM	29916401OM	

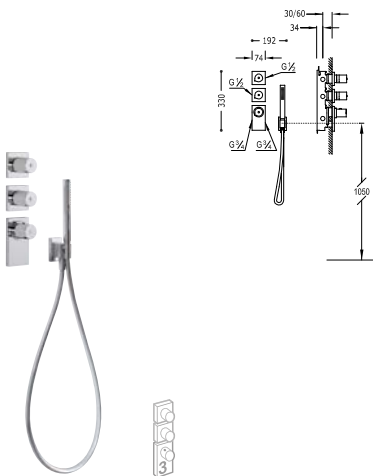

	20635391	849,00
	20635391NM	1.401,00
	20635391BM	1.401,00
	20635391AC	1.401,00
	20635391OR	1.697,00
	20635391OM	1.697,00



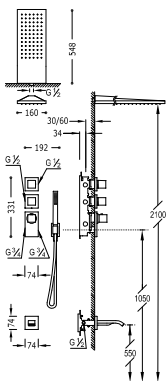

Concealed thermostatic bath kit BLOCK SYSTEM

with water shut off and flow control (3 ways).

- Built-in thermostatic body included.
- Stainless steel wall shower 160x550 mm.
- Cascade cast spout.
- Anti-limescale hand shower.
- Shower hose SATIN.

29925045
29925045NM
29925045BM
29925045AC



Kit termostatico vasca ad incasso BLOCK SYSTEM

Con chiusura e regolazione di portata (3 vie).

- Corpo incassato termostatico incluso.
- Doccia acciaio inossidabile da parete 160x550 mm.
- Tubo cascata vasca.
- Doccetta anticalcare.
- Flessibile satin.

Termostatický podomítkový vanový set BLOCK SYSTEM

s uzávěrem a regulací průtoku (3-cestná).

- Včetně podomítkového termostatického tělesa.
- Nástěnné sprchové křepítko z nerez. oceli 160x550 mm.
- Ramínko s kaskádou pro vanu.
- Ruční sprcha, proti usaz. vod. kamene.
- Flexi hadice SATIN.

20625301 1.268,00

20625301NM 2.093,00

20625301BM 2.093,00

20625301AC 2.093,00

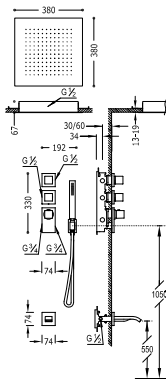

Concealed thermostatic bath kit BLOCK SYSTEM

with water shut off and flow control (3 ways).

- Built-in thermostatic body included.
- Stainless steel ceiling shower 380x380 mm.
- Cascade cast spout.
- Anti-limescale hand shower.
- Shower hose SATIN.

29925045



Kit termostatico vasca ad incasso BLOCK SYSTEM

Con chiusura e regolazione di portata (3 vie).

- Corpo incassato termostatico incluso.
- Soffione doccia acciaio inossidabile 380x380 mm.
- Tubo cascata vasca.
- Doccetta anticalcare.
- Flessibile satin.

Termostatický podomítkový vanový set BLOCK SYSTEM

s uzávěrem a regulací průtoku (3-cestná).

- Včetně podomítkového termostatického tělesa.
- Stropní sprchové křepítko z nerez. oceli 380x380 mm.
- Ramínko s kaskádou pro vanu.
- Ruční sprcha, proti usaz. vod. kamene.
- Flexi hadice SATIN.

20625302 1.504,00



Concealed thermostatic bath kit BLOCK SYSTEM

with water shut off and flow control (3 ways).

- Built-in thermostatic body included.
- Stainless steel wall shower 160x550 mm.
- Bath spout.
- Anti-limescale hand shower.
- Shower hose SATIN.

29916401
29916401NM
29916401BM
29916401AC



Kit termostatico vasca ad incasso BLOCK SYSTEM

Con chiusura e regolazione di portata (3 vie).

- Corpo incassato termostatico incluso.
- Doccia acciaio inossidabile da parete 160x550 mm.
- Canna per vasca da bagno.
- Doccetta anticalcare.
- Flessibile satin.

Termostatický podomítkový vanový set BLOCK SYSTEM

s uzávěrem a regulací průtoku (3-cestná).

- Včetně podomítkového termostatického tělesa.
- Nástěnné sprchové kropítko z nerez. oceli 160x550 mm.
- Kohoutek pro vanu.
- Ruční sprcha, proti usaz. vod. kamene.
- Flexi hadice SATIN.

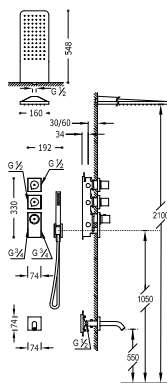

20635301 1.261,00

M 20635301NM 2.081,00

M 20635301BM 2.081,00

M 20635301AC 2.081,00



Recommended installation Installazione consigliata Doporučená instalace

This is the installation scheme recommended to enjoy the tap functions to the full.

Questo è uno schema dell'installazione consigliata per ottimizzare le funzioni del rubinetto.

Zde je doporučené schéma pro instalaci, pro zajištění maximálního využití funkcí baterie.

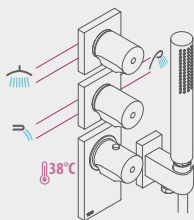

206.353.01 / 206.353.01.AC / 206.353.01.NM / 206.353.01.BM



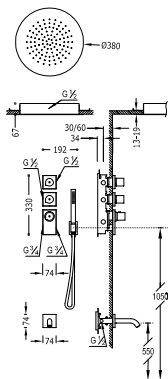

Concealed thermostatic bath kit BLOCK SYSTEM

- with water shut off and flow control (3 ways).
- Built-in thermostatic body included.
- Stainless steel ceiling shower Ø 380 mm.
- Bath spout.
- Anti-limescale hand shower.
- Shower hose SATIN.

29916401
29916401NM
29916401BM
29916401AC

Kit termostatico vasca ad incasso BLOCK SYSTEM

- Con chiusura e regolazione di portata (3 vie).
- Corpo incassato termostatico incluso.
- Soffione doccia acciaio inossidabile Ø 380 mm.
- Canna per vasca da bagno.
- Doccetta anticalcare.
- Flessibile satin.

Termostatický podomítkový vanový set BLOCK SYSTEM

- s uzávěrem a regulací průtoku (3-cestná).
- Včetně podomítkového termostatického tělesa.
- Stropní sprchové kropítko z nerez. oceli Ø 380 mm.
- Kohoutek pro vanu.
- Ruční sprcha, proti usaz. vod. kamene.
- Flexi hadice SATIN.

20635302 1.474,00

20635302NM 2.433,00

20635302BM 2.433,00

20635302AC 2.433,00



**Concealed thermostatic mixer
BLOCK SYSTEM**

with water shut off and flow control (4 ways).

- Built-in thermostatic body included
- Anti-limescale hand shower.
- Shower hose SATIN.

Termostatica ad incasso BLOCK SYSTEM

Con chiusura e regolazione di portata (4 vie).

- Corpo incassato termostatico incluso
- Doccetta anticalcare.
- Flessibile satin.

Termostatická baterie podomítková BLOCK SYSTEM

s uzávěrem a regulací průtoku (4-cestná)

- Včetně podomítkového termostatického tělesa
- Ruční sprcha, proti usaz. vod. kamene.
- Flexi hadice SATIN.

29925045	29925045AC	
29925045NM	29925045OR	
29925045BM	29925045OM	

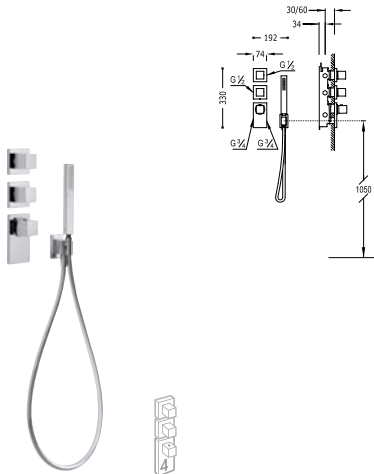

	20625491	859,00
--	----------	---------------

	20625491NM	1.418,00
--	------------	-----------------

	20625491BM	1.418,00
--	------------	-----------------

	20625491AC	1.418,00
--	------------	-----------------

	20625491OR	1.718,00
--	------------	-----------------

	20625491OM	1.718,00
--	------------	-----------------



**Concealed thermostatic mixer
BLOCK SYSTEM**

with water shut off and flow control (4 ways).

- Built-in thermostatic body included
- Anti-limescale hand shower.
- Shower hose SATIN.

Termostatica ad incasso BLOCK SYSTEM

Con chiusura e regolazione di portata (4 vie).

- Corpo incassato termostatico incluso
- Doccetta anticalcare.
- Flessibile satin.

Termostatická baterie podomítková BLOCK SYSTEM

s uzávěrem a regulací průtoku (4-cestná)

- Včetně podomítkového termostatického tělesa
- Ruční sprcha, proti usaz. vod. kamene.
- Flexi hadice SATIN.

29916401	29916401AC	
29916401NM	29916401OR	
29916401BM	29916401OM	

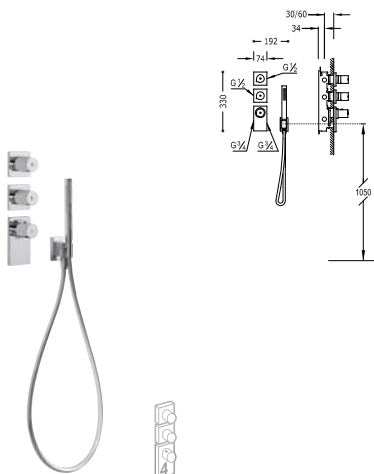

	20635491	849,00
--	----------	---------------

	20635491NM	1.401,00
--	------------	-----------------

	20635491BM	1.401,00
--	------------	-----------------

	20635491AC	1.401,00
--	------------	-----------------

	20635491OR	1.697,00
--	------------	-----------------

	20635491OM	1.697,00
--	------------	-----------------



BLOCK SYSTEM

248 /



250 / 2 ways | vie | cestná



264 / 3 ways | vie | cestná



276 / 4 ways | vie | cestná



SHOWER TECHNOLOGY



www.qtr.es/shower-technology



SHOWER
TECH.



Chrome
Cromato
Chrom



Matt Black
Nero Opaco
Cerná mat



Matt White
Bianco Opaco
Bílá mat



Steel
Acciaio
Ocel

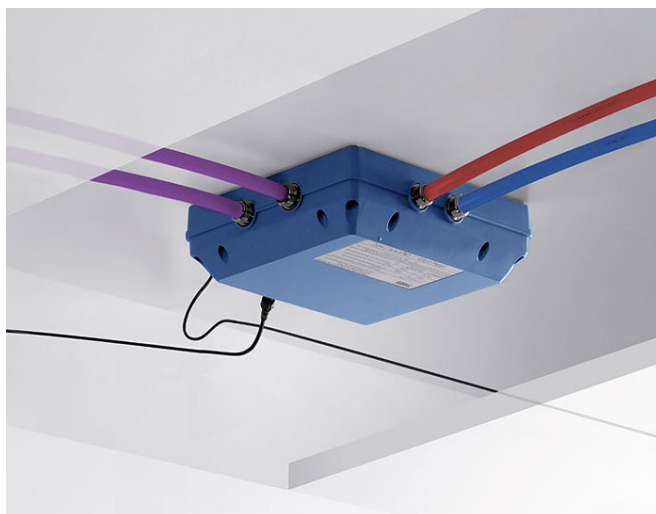

Prepare your shower so it is perfect when you get in

The tap stops when it reaches the programmed temperature and the shower is ready for you to enter whenever you like.

Prepara la doccia a tuo piacimento perché sia perfetta prima di entrare

Il rubinetto si chiude quando viene raggiunta la temperatura programmata e la doccia è pronta al tuo ingresso.

Připraví vám sprchu. Jakmile vstoupíte, je nastavena

S dosažením nastavené teploty se fáze přípravy zastaví. Od teď sprcha čeká jen na váš příchod.



SHOWER TECHNOLOGY BLUE EDITION

Electronic showers at the next level

La doccia elettronica a un livello superiore

Elektronická sprcha na nové úrovni

TRES has improved its electronic innovation for absolute control of the shower. On the outside, it's the same Shower Technology as ever. But on the inside, it's on a whole other level. The Blue Edition version features improved technology and new functions to increase safety, water saving and shower comfort when everything is ready.

TRES ha migliorato l'innovazione elettronica per avere un controllo assoluto della doccia. Esternamente è la Shower Technology di sempre. Internamente, siamo su un altro livello. La versione Blue Edition migliora la propria tecnologia e integra nuove caratteristiche, per aumentare sicurezza, risparmio di acqua e comodità, e fare la doccia quando tutto è pronto.

TRES vylepšila svou elektronickou inovaci pro absolutní kontrolu nad sprchou. Navenek se tváří jako dobře známá Shower Technology. Uvnitř však pracuje technologie nové generace. Verze Blue Edition přichází s přepracovanou technologií a novými schopnostmi. Pro vaši vyšší bezpečnost, větší úsporu vody a vyšší komfort při sprchování. Až do sprchy vstoupíte, bude vše připraveno.



It has the best anti-moisture seals
Totally waterproof and anti-humidity built-in system with Schlüter seals.

È dotato delle migliori giunture antiumidità
Sistema incassato, totalmente a tenuta stagna e anti-umidità con giunti Schlüter.

Součástí je nejlepší těsnění proti vlhkosti
Absolutně vodotěsný podomítkový systém s těsněním značky Schlüter chrání před průnikem vlhkosti.



More refreshing showers
You can set the temperature to "low" mode, allowing you to go below 25°C whilst maintaining comfort and safety.

Docce più rinfrescanti
Puoi regolare la temperatura fino alla modalità "low", che permette di scendere sotto i 25°C, mantenendo comfort e sicurezza.

Sprchování pro maximální osvěžení
Regulace teploty umožňuje nastavení až do režimu "low". I při ochlazení pod 25°C vám bude dál zajišťovat komfort a bezpečnost.



Enables legionella disinfection
Includes a program to prevent legionella (5 minutes at 60°), or to disinfect directly (10 minutes at 60°).

Permette la disinfezione dalla legionella
Dotato di un programma per prevenire la legionella (5 minuti a 60°) o direttamente per disinfettare (10 minuti a 60°).

Možnost odstranění legionelly dezinfekcí
Součástí je možnost prevence legionelly termickou dezinfekcí: s naprogramováním (5 minut při 60 °C) nebo ad hoc (10 minut při 60 °C).



SHOWER TECHNOLOGY BLUE EDITION built-in electronic thermostat control

- Electronic control included with Schlüter anti-moisture seals.
- Electronic thermostatic control box included (2 ways).
- Minimum available temperature lower than 25°C.
- Tuning system: Preparation of the desired temperature.
- With anti-legionella programs.

Controllo termostatico elettronico a incasso SHOWER TECHNOLOGY BLUE EDITION

- Controllo elettronico incluso con guarnizioni antiumidità Schlüter.
- Centralina termostatica elettronica inclusa (2 vie).
- Temperatura minima disponibile inferiore a 25°C.
- Sistema di messa a punto: Preparazione della temperatura desiderata.
- Con programma antilegionella.

Zapuštěné elektronické termostatické ovládní SHOWER TECHNOLOGY BLUE EDITION

- Součástí kontrolní skříňka s těsněním od firmy Schlüter.
- Zabudovaná termostatická elektronická kontrolní jednotka (2-cestná).
- Minimální dostupná teplota pod 25 °C.
- Systém seřizování: Příprava požadované teploty.
- Obsahuje programy proti legionelle.

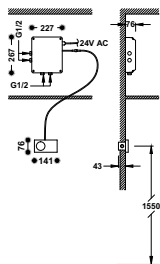

49286299
49288299

796,00
796,00

SHOWER TECHNOLOGY BLUE EDITION built-in electronic thermostat control

- Electronic control included with Schlüter anti-moisture seals.
- Electronic thermostatic control box included (3 ways).
- Minimum available temperature lower than 25°C.
- Tuning system: Preparation of the desired temperature.
- With anti-legionella programs.

Controllo termostatico elettronico a incasso SHOWER TECHNOLOGY BLUE EDITION

- Controllo elettronico incluso con guarnizioni antiumidità Schlüter.
- Centralina termostatica elettronica inclusa (3 vie).
- Temperatura minima disponibile inferiore a 25°C.
- Sistema di messa a punto: Preparazione della temperatura desiderata.
- Con programma antilegionella.

Zapuštěné elektronické termostatické ovládní SHOWER TECHNOLOGY BLUE EDITION

- Součástí kontrolní skříňka s těsněním od firmy Schlüter.
- Zabudovaná termostatická elektronická kontrolní jednotka (3-cestná).
- Minimální dostupná teplota pod 25 °C.
- Systém seřizování: Příprava požadované teploty.
- Obsahuje programy proti legionelle.

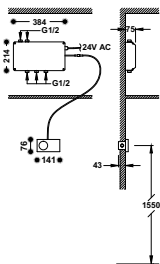

49286398
49288398

849,00
849,00

SHOWER TECHNOLOGY BLUE EDITION built-in electronic thermostat control

- Electronic control included with Schlüter anti-moisture seals.
- Electronic thermostatic control box included (3 ways).
- Minimum available temperature lower than 25°C.
- Tuning system: Preparation of the desired temperature.
- With anti-legionella programs.

Controllo termostatico elettronico a incasso SHOWER TECHNOLOGY BLUE EDITION

- Controllo elettronico incluso con guarnizioni anti-umidità Schlüter.
- Centralina termostatica elettronica inclusa (3 vie).
- Temperatura minima disponibile inferiore a 25°C.
- Sistema di messa a punto: Preparazione della temperatura desiderata.
- Con programma antilegionella.

Zapuštěné elektronické termostatické ovládání SHOWER TECHNOLOGY BLUE EDITION

- Součástí kontrolní skříňka s těsněním od firmy Schlüter.
- Zabudovaná termostatická elektronická kontrolní jednotka (3-cestná).
- Minimální dostupná teplota pod 25 °C.
- Systém seřizování: Příprava požadované teploty.
- Obsahuje programy proti legionelle.

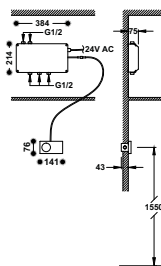

	49286399	849,00
	49288399	849,00

SHOWER TECHNOLOGY BLUE EDITION built-in electronic thermostat control

- Electronic control included with Schlüter anti-moisture seals.
- Electronic thermostatic control box included (4 ways).
- Minimum available temperature lower than 25°C.
- Tuning system: Preparation of the desired temperature.
- With anti-legionella programs.

Controllo termostatico elettronico a incasso SHOWER TECHNOLOGY BLUE EDITION

- Controllo elettronico incluso con guarnizioni anti-umidità Schlüter.
- Centralina termostatica elettronica inclusa (4 vie).
- Temperatura minima disponibile inferiore a 25°C.
- Sistema di messa a punto: Preparazione della temperatura desiderata.
- Con programma antilegionella.

Zapuštěné elektronické termostatické ovládání SHOWER TECHNOLOGY BLUE EDITION

- Součástí kontrolní skříňka s těsněním od firmy Schlüter.
- Zabudovaná termostatická elektronická kontrolní jednotka (4-cestná).
- Minimální dostupná teplota pod 25 °C.
- Systém seřizování: Příprava požadované teploty.
- Obsahuje programy proti legionelle.

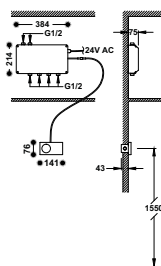

	49286499	902,00
	49288499	902,00

Shower holder with wall water outlet and check valve.

Supporto per doccia con presa d'acqua a parete e valvola antiritorno

Úchyt ruční sprchy se stěnovou přípojkou vody s nastavitelným výstupem pro vodu a zpětným ventilem.

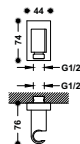

	20718201	56,25
	M 20718201NM	92,85
	M 20718201BM	92,85
	20718201AC	92,85
	20718201OR	113,00
	20718201OM	113,00

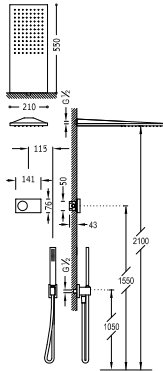

Built-in electronic thermostatic shower kit SHOWER TECHNOLOGY BLUE EDITION

- Electronic control included with Schlüter anti-moisture seals.
- Electronic thermostatic control box included (2 ways).
- Stainless steel wall shower 210x550 mm.
- Elbow wall.
- Antilime hand shower.
- Shower hose SATIN.

Kit elettronico per doccia termostatica da incasso SHOWER TECHNOLOGY BLUE EDITION

- Controllo elettronico incluso con guarnizioni anti-umidità Schlüter.
- Centralina termostatica elettronica inclusa (2 vie).
- Doccia acciaio inossidabile da parete 210x550 mm.
- Supporto per doccia.
- Doccetta anticalcare.
- Flessibile satin.

Termostatický podomítkový elektronický sprchový set SHOWER TECHNOLOGY BLUE EDITION

- Součástí kontrolní skříňka s těsněním od firmy Schlüter.
- Zabudovaná termostatická elektronická kontrolní jednotka (2-cestná).
- Nástěnné sprchové křepítko z nerez. oceli 210x550 mm.
- Držák s nástěnným přívodem vody.
- Ruční sprcha, proti usaz. vod. kamene.
- Flexi hadice SATIN.



09286551

1.045,00

M 09286551BM

1.491,00

09286551AC

1.491,00



09288551

1.045,00

09288551NM

1.491,00

09288551AC

1.491,00

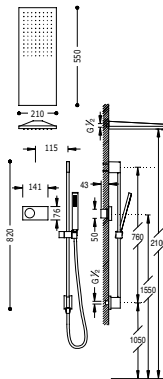

Built-in electronic thermostatic shower kit SHOWER TECHNOLOGY BLUE EDITION

- Electronic control included with Schlüter anti-moisture seals.
- Electronic thermostatic control box included (2 ways).
- Stainless steel wall shower 210x550 mm.
- Sliding bar with wall water intake. Length: 760 mm.
- Antilime hand shower.
- Shower hose SATIN.

Kit elettronico per doccia termostatica da incasso SHOWER TECHNOLOGY BLUE EDITION

- Controllo elettronico incluso con guarnizioni anti-umidità Schlüter.
- Centralina termostatica elettronica inclusa (2 vie).
- Doccia acciaio inossidabile da parete 210x550 mm.
- Barra di scorrimento con presa d'acqua a parete. Lung. 760 mm.
- Doccetta anticalcare.
- Flessibile satin.

Termostatický podomítkový elektronický sprchový set SHOWER TECHNOLOGY BLUE EDITION

- Součástí kontrolní skříňka s těsněním od firmy Schlüter.
- Zabudovaná termostatická elektronická kontrolní jednotka (2-cestná).
- Nástěnné sprchové křepítko z nerez. oceli 210x550 mm.
- Posuvná tyč s nástěnným přívodem vody. Délka 760 mm.
- Ruční sprcha, proti usaz. vod. kamene.
- Flexi hadice SATIN.



09286580

1.101,00



09288580

1.101,00





Built-in electronic thermostatic shower kit SHOWER TECHNOLOGY BLUE EDITION

- Electronic control included with Schlüter anti-moisture seals.
- Electronic thermostatic control box included (2 ways).
- Stainless steel ceiling shower 380x380 mm.
- Elbow wall.
- Antilime hand shower.
- Shower hose SATIN.

Kit elettronico per doccia termostatico da incasso SHOWER TECHNOLOGY BLUE EDITION

- Controllo elettronico incluso con guarnizioni antiumidità Schlüter.
- Centralina termostatica elettronica inclusa (2 vie).
- Soffione doccia acciaio inossidabile 380x380 mm.
- Supporto per doccia.
- Doccetta anticalcare.
- Flessibile satin.

Termostatický podomítkový elektronický sprchový set SHOWER TECHNOLOGY BLUE EDITION

- Součástí kontrolní skříňka s těsněním od firmy Schlüter.
- Zabudovaná termostatická elektronická kontrolní jednotka (2-cestná).
- Stropní sprchové křepitko z nerez. oceli 380x380 mm.
- Držák s nástěnným přívodem vody.
- Ruční sprcha, proti usaz. vod. kamene.
- Flexi hadice SATIN.

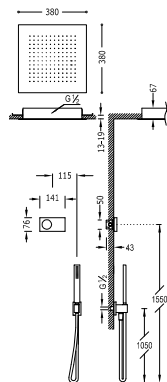

	09286552	1.246,00
	M 09286552BM	1.806,00
	09286552AC	1.806,00

	09288552	1.246,00
	M 09288552NM	1.806,00
	09288552AC	1.806,00



Built-in electronic thermostatic shower kit SHOWER TECHNOLOGY BLUE EDITION

- Electronic control included with Schlüter anti-moisture seals.
- Electronic thermostatic control box included (2 ways).
- Stainless steel ceiling shower 500x500 mm.
- Sliding bar with wall water intake. Length: 760 mm.
- Antilime hand shower.
- Shower hose SATIN.

Kit elettronico per doccia termostatico da incasso SHOWER TECHNOLOGY BLUE EDITION

- Controllo elettronico incluso con guarnizioni antiumidità Schlüter.
- Centralina termostatica elettronica inclusa (2 vie).
- Soffione doccia acciaio inossidabile 500x500 mm.
- Barra di scorrimento con presa d'acqua a parete. Lung. 760 mm.
- Doccetta anticalcare.
- Flessibile satin.

Termostatický podomítkový elektronický sprchový set SHOWER TECHNOLOGY BLUE EDITION

- Součástí kontrolní skříňka s těsněním od firmy Schlüter.
- Zabudovaná termostatická elektronická kontrolní jednotka (2-cestná).
- Stropní sprchové křepitko z nerez. oceli 500x500 mm.
- Posuvná tyč s nástěnným přívodem vody. Délka 760 mm.
- Ruční sprcha, proti usaz. vod. kamene.
- Flexi hadice SATIN.

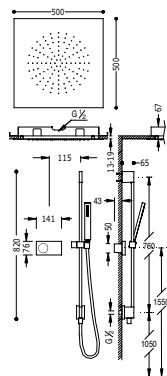

	09286581	1.503,00
--	----------	----------

	09288581	1.503,00
--	----------	----------



SHOWER TECH.

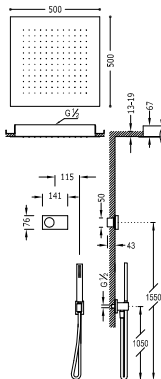

Built-in electronic thermostatic shower kit SHOWER TECHNOLOGY BLUE EDITION

- Electronic control included with Schlüter anti-moisture seals.
- Electronic thermostatic control box included (2 ways).
- Stainless steel ceiling shower 500x500 mm.
- Elbow wall.
- Antilime hand shower.
- Shower hose SATIN.

Kit elettronico per doccia termostatico da incasso SHOWER TECHNOLOGY BLUE EDITION

- Controllo elettronico incluso con guarnizioni anti-umidità Schlüter.
- Centralina termostatica elettronica inclusa (2 vie).
- Soffione doccia acciaio inossidabile 500x500 mm.
- Supporto per doccia.
- Doccetta anticalcare.
- Flessibile satin.

Termostatický podomítkový elektronický sprchový set SHOWER TECHNOLOGY BLUE EDITION

- Součástí kontrolní skříňka s těsněním od firmy Schlüter.
- Zabudovaná termostatická elektronická kontrolní jednotka (2-cestná).
- Sprchové křepítko z nerez. oceli 500x500 mm.
- Držák s nástěnným přívodem vody.
- Ruční sprcha, proti usaz. vod. kamene.
- Flexi hadice SATIN.



09286561

1.449,00

M 09286561BM

2.101,00

09286561AC

2.101,00



09288561

1.449,00

09288561NM

2.101,00

09288561AC

2.101,00

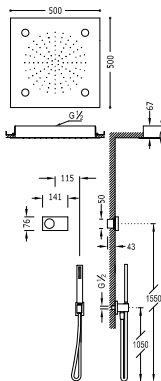

Built-in electronic thermostatic shower kit SHOWER TECHNOLOGY BLUE EDITION CHROMOTHERAPY

- Electronic control included with Schlüter anti-moisture seals.
- Electronic thermostatic control box included (2 ways).
- Stainless steel ceiling shower 500x500 mm.
- Elbow wall.
- Antilime hand shower.
- Shower hose SATIN.

Kit elettronico per doccia termostatico da incasso SHOWER TECHNOLOGY BLUE EDITION CHROMOTHERAPY

- Controllo elettronico incluso con guarnizioni anti-umidità Schlüter.
- Centralina termostatica elettronica inclusa (2 vie).
- Soffione doccia acciaio inossidabile 500x500 mm.
- Supporto per doccia.
- Doccetta anticalcare.
- Flessibile satin.

Termostatický podomítkový elektronický sprchový set SHOWER TECHNOLOGY BLUE EDITION CHROMOTHERAPY

- Součástí kontrolní skříňka s těsněním od firmy Schlüter.
- Zabudovaná termostatická elektronická kontrolní jednotka (2-cestná).
- Stropní sprchové křepítko z nerez. oceli 500x500 mm.
- Držák s nástěnným přívodem vody.
- Ruční sprcha, proti usaz. vod. kamene.
- Flexi hadice SATIN.



09286562

1.889,00



09286562

1.889,00



Built-in electronic thermostatic shower kit SHOWER TECHNOLOGY BLUE EDITION

- Electronic control included with Schlüter anti-moisture seals.
- Electronic thermostatic control box included (2 ways).
- Fixed shower head 300x300 mm. with ball joint. Brass.
- Elbow wall.
- Antilime hand shower.
- Shower hose SATIN.

Kit elettronico per doccia termostatica da incasso SHOWER TECHNOLOGY BLUE EDITION

- Controllo elettronico incluso con guarnizioni antimidità Schlüter.
- Centralina termostatica elettronica inclusa (2 vie).
- Doccia fissa 300x300 mm. con snodo. Ottone.
- Supporto per doccia.
- Doccetta anticalcare.
- Flessibile satin.

Termostatický podomítkový elektronický sprchový set SHOWER TECHNOLOGY BLUE EDITION

- Součástí kontrolní skříňka s těsněním od firmy Schlüter.
- Zabudovaná termostatická elektronická kontrolní jednotka (2-cestná).
- Pevná sprcha 300x300 mm. s kloubem. Materiál mosaz.
- Držák s nástěnným přívodem vody.
- Ruční sprcha, proti usaz. vod. kamene.
- Flexi hadice SATIN.

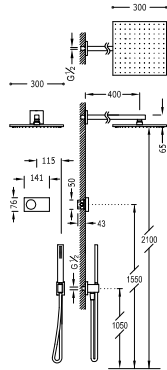

	09286563	927,00
	M 09286563BM	1.323,00
	09286563AC	1.323,00

	09288563	927,00
	M 09288563NM	1.323,00
	09288563AC	1.323,00



Built-in electronic thermostatic shower kit SHOWER TECHNOLOGY BLUE EDITION

- Electronic control included with Schlüter anti-moisture seals.
- Electronic thermostatic control box included (2 ways).
- Fixed shower head 300x300 mm. with ball joint. Brass.
- Elbow wall.
- Antilime hand shower.
- Shower hose SATIN.

Kit elettronico per doccia termostatica da incasso SHOWER TECHNOLOGY BLUE EDITION

- Controllo elettronico incluso con guarnizioni antimidità Schlüter.
- Centralina termostatica elettronica inclusa (2 vie).
- Doccia fissa 300x300 mm. con snodo. Ottone.
- Supporto per doccia.
- Doccetta anticalcare.
- Flessibile satin.

Termostatický podomítkový elektronický sprchový set SHOWER TECHNOLOGY BLUE EDITION

- Součástí kontrolní skříňka s těsněním od firmy Schlüter.
- Zabudovaná termostatická elektronická kontrolní jednotka (2-cestná).
- Pevná sprcha 300x300 mm. s kloubem. Materiál mosaz.
- Držák s nástěnným přívodem vody.
- Ruční sprcha, proti usaz. vod. kamene.
- Flexi hadice SATIN.

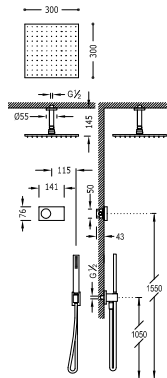

	09286564	897,00
	M 09286564BM	1.281,00
	09286564AC	1.281,00

	09288564	897,00
	M 09288564NM	1.281,00
	09288564AC	1.281,00



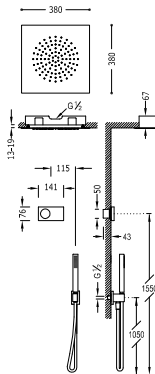

Built-in electronic thermostatic shower kit SHOWER TECHNOLOGY BLUE EDITION

- Electronic control included with Schlüter anti-moisture seals.
- Electronic thermostatic control box included (2 ways).
- Stainless steel ceiling shower 380x380 mm.
- Elbow wall.
- Antilime hand shower.
- Shower hose SATIN.

Kit elettronico per doccia termostatico da incasso SHOWER TECHNOLOGY BLUE EDITION

- Controllo elettronico incluso con guarnizioni anti-umidità Schlüter.
- Centralina termostatica elettronica inclusa (2 vie).
- Soffione doccia acciaio inossidabile 380x380 mm.
- Supporto per doccia.
- Doccetta anticalcare.
- Flessibile satin.

Termostatický podomítkový elektronický sprchový set SHOWER TECHNOLOGY BLUE EDITION

- Součásti kontrolní skříňka s těsněním od firmy Schlüter.
- Zabudovaná termostatická elektronická kontrolní jednotka (2-cestná).
- Stropní sprchové křepítko z nerez. oceli 380x380 mm.
- Držák s nástěnným přívodem vody.
- Ruční sprcha, proti usaz. vod. kamene.
- Flexi hadice SATIN.



09286584

1.246,00

M 09286584 BM

1.806,00

09286584 AC

1.806,00



09288584

1.246,00

09288584 NM

1.806,00

09288584 AC

1.806,00

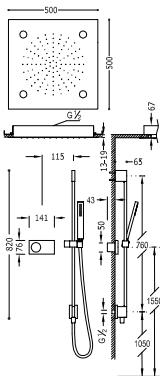

Built-in electronic thermostatic shower kit SHOWER TECHNOLOGY BLUE EDITION CHROMOTHERAPY

- Electronic control included with Schlüter anti-moisture seals.
- Electronic thermostatic control box included (2 ways).
- Stainless steel ceiling shower 500x500 mm.
- Sliding bar with wall water intake. Length: 760 mm.
- Antilime hand shower.
- Shower hose SATIN.

Kit elettronico per doccia termostatico da incasso SHOWER TECHNOLOGY BLUE EDITION CHROMOTHERAPY

- Controllo elettronico incluso con guarnizioni anti-umidità Schlüter.
- Centralina termostatica elettronica inclusa (2 vie).
- Soffione doccia acciaio inossidabile 500x500 mm.
- Barra di scorrimento con presa d'acqua a parete. Lung. 760 mm.
- Doccetta anticalcare.
- Flessibile satin.

Termostatický podomítkový elektronický sprchový set SHOWER TECHNOLOGY BLUE EDITION CHROMOTHERAPY

- Součásti kontrolní skříňka s těsněním od firmy Schlüter.
- Zabudovaná termostatická elektronická kontrolní jednotka (2-cestná).
- Stropní sprchové křepítko z nerez. oceli 500x500 mm.
- Posuvná tyč s nástěnným přívodem vody. Délka 760 mm.
- Ruční sprcha, proti usaz. vod. kamene.
- Flexi hadice SATIN.



09286585

1.942,00



09288585

1.942,00



Built-in electronic thermostatic bath kit SHOWER TECHNOLOGY BLUE EDITION

- Electronic control included with Schlüter anti-moisture seals.
- Electronic thermostatic control box included (2 ways).
- Steel cascade cast spout.
- Elbow wall.
- Antilime hand shower.
- Shower hose SATIN.

Kit elettronico per vasca da bagno termostatico da incasso SHOWER TECHNOLOGY BLUE EDITION

- Controllo elettronico incluso con guarnizioni antiumidità Schlüter.
- Centralina termostatica elettronica inclusa (2 vie).
- Tubo cascata vasca acciaio inossidabile.
- Supporto per doccia.
- Doccetta anticalcare.
- Flessibile satin.

Termostatický podomítkový elektronický vanový set SHOWER TECHNOLOGY BLUE EDITION

- Součástí kontrolní skříňka s těsněním od firmy Schlüter.
- Zabudovaná termostatická elektronická kontrolní jednotka (2-cestná).
- Vanový ramínko s kaskádou z nerez. oceli.
- Držák s nástěnným přívodem vody.
- Ruční sprcha, proti usaz. vod. kamene.
- Flexi hadice SATIN.

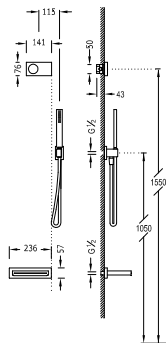

(1)	09286553	980,00
	M 09286553BM	1.413,00
	09286553AC	1.413,00
(1)	09288553	980,00
	M 09288553NM	1.413,00
	09288553AC	1.413,00

Built-in electronic thermostatic bath kit SHOWER TECHNOLOGY BLUE EDITION

- Electronic control included with Schlüter anti-moisture seals.
- Electronic thermostatic control box included (2 ways).
- Steel cascade cast spout.
- Antilime hand shower.
- Shower hose SATIN.

Kit elettronico per vasca da bagno termostatico da incasso SHOWER TECHNOLOGY BLUE EDITION

- Controllo elettronico incluso con guarnizioni antiumidità Schlüter.
- Centralina termostatica elettronica inclusa (2 vie).
- Tubo cascata vasca acciaio inossidabile.
- Doccetta anticalcare.
- Flessibile satin.

Termostatický podomítkový elektronický vanový set SHOWER TECHNOLOGY BLUE EDITION

- Součástí kontrolní skříňka s těsněním od firmy Schlüter.
- Zabudovaná termostatická elektronická kontrolní jednotka (2-cestná).
- Vanové ramínko s kaskádou z nerez. oceli.
- Ruční sprcha, proti usaz. vod. kamene.
- Flexi hadice SATIN.

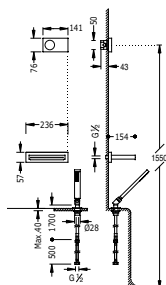

(1)	09286570	1.086,00
	M 09286570BM	1.520,00
	09286570AC	1.520,00
(1)	09288570	1.086,00
	M 09288570NM	1.520,00
	09288570AC	1.520,00

Built-in electronic thermostatic bath kit SHOWER TECHNOLOGY BLUE EDITION

- Electronic control included with Schlüter anti-moisture seals.
- Electronic thermostatic control box included (2 ways).
- Steel cascade cast spout.
- Antilime hand shower.
- Shower hose SATIN.

Kit elettronico per vasca da bagno termostatico da incasso SHOWER TECHNOLOGY BLUE EDITION

- Controllo elettronico incluso con guarnizioni antimidità Schlüter.
- Centralina termostatica elettronica inclusa (2 vie).
- Tubo cascata vasca acciaio inossidabile.
- Doccetta anticalcare.
- Flessibile satin.

Termostatický podomítkový elektronický vanový set SHOWER TECHNOLOGY BLUE EDITION

- Součástí kontrolní skříňka s těsněním od firmy Schlüter.
- Zabudovaná termostatická elektronická kontrolní jednotka (2-cestná).
- Vanové ramínko s kaskádou z nerez. oceli.
- Ruční sprcha, proti usaz. vod. kamene.
- Flexi hadice SATIN.

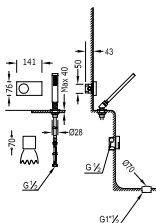

09286571

820,00



09288571

820,00

Built-in electronic thermostatic shower kit SHOWER TECHNOLOGY BLUE EDITION

- Electronic control included with Schlüter anti-moisture seals.
- Electronic thermostatic control box included (2 ways).
- Stainless steel wall shower 210x550 mm.
- Elbow wall.
- Antilime hand shower.
- Shower hose SATIN.

Kit elettronico per doccia termostatico da incasso SHOWER TECHNOLOGY BLUE EDITION

- Controllo elettronico incluso con guarnizioni antimidità Schlüter.
- Centralina termostatica elettronica inclusa (2 vie).
- Doccia acciaio inossidabile da parete 210x550 mm.
- Supporto per doccia.
- Doccetta anticalcare.
- Flessibile satin.

Termostatický podomítkový elektronický sprchový set SHOWER TECHNOLOGY BLUE EDITION

- Součástí kontrolní skříňka s těsněním od firmy Schlüter.
- Zabudovaná termostatická elektronická kontrolní jednotka (2-cestná).
- Nástěnné sprchové hroplíto z nerez. oceli 210x550 mm.
- Držák s nástěnným přívodem vody.
- Ruční sprcha, proti usaz. vod. kamene.
- Flexi hadice SATIN.

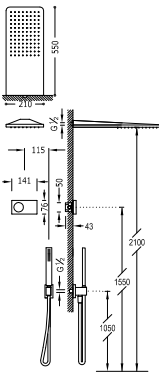

09286554

1.109,00

09286554BM

1.596,00

09286554AC

1.596,00



09288554

1.109,00

09288554NM

1.596,00

09288554AC

1.596,00



Built-in electronic thermostatic shower kit SHOWER TECHNOLOGY BLUE EDITION

- Electronic control included with Schlüter anti-moisture seals.
- Electronic thermostatic control box included (2 ways).
- Stainless steel wall shower 210x550 mm.
- Sliding bar with wall water intake. Length: 760 mm.
- Antilime hand shower.
- Shower hose SATIN.

Kit elettronico per doccia termostatico da incasso SHOWER TECHNOLOGY BLUE EDITION

- Controllo elettronico incluso con guarnizioni anti-umidità Schlüter.
- Centralina termostatica elettronica inclusa (2 vie).
- Doccia acciaio inossidabile da parete 210x550 mm.
- Barra di scorrimento con presa d'acqua a parete. Lung. 760 mm.
- Doccetta anticalcare.
- Flessibile satin.

Termostatický podomítkový elektronický sprchový set SHOWER TECHNOLOGY BLUE EDITION

- Součástí kontrolní skříňka s těsněním od firmy Schlüter.
- Zabudovaná termostatická elektronická kontrolní jednotka (2-cestná).
- Nástěnné sprchové křepítko z nerez. oceli 210x550 mm.
- Posuvná tyč s nástěnným přívodem vody. Délka 760 mm.
- Ruční sprcha, proti usaz. vod. kamene.
- Flexi hadice SATIN.

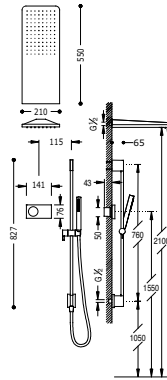

09286582

1.165,00



09288582

1.165,00



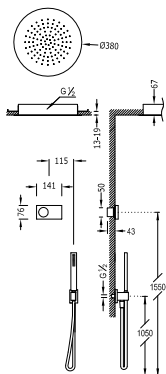

Built-in electronic thermostatic shower kit SHOWER TECHNOLOGY BLUE EDITION

- Electronic control included with Schlüter anti-moisture seals.
- Electronic thermostatic control box included (2 ways).
- Stainless steel ceiling shower Ø 380 mm.
- Elbow wall.
- Antilime hand shower.
- Shower hose SATIN.

Kit elettronico per doccia termostatico da incasso SHOWER TECHNOLOGY BLUE EDITION

- Controllo elettronico incluso con guarnizioni anti-umidità Schlüter.
- Centralina termostatica elettronica inclusa (2 vie).
- Soffione doccia acciaio inossidabile Ø 380 mm.
- Supporto per doccia.
- Doccetta anticalcare.
- Flessibile satin.

Termostatický podomítkový elektronický sprchový set SHOWER TECHNOLOGY BLUE EDITION

- Součásti kontrolní skříňka s těsněním od firmy Schlüter.
- Zabudovaná termostatická elektronická kontrolní jednotka (2-cestná).
- Stropní sprchové křepitko z nerez. oceli Ø 380 mm.
- Držák s nástěnným přívodem vody.
- Ruční sprcha, proti usaz. vod. kamene.
- Flexi hadice SATIN.



09286555

1.287,00

M 09286555BM

1.877,00

09286555AC

1.877,00



09288555

1.287,00

09288555NM

1.877,00

09288555AC

1.877,00

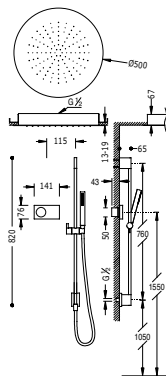

Built-in electronic thermostatic shower kit SHOWER TECHNOLOGY BLUE EDITION

- Electronic control included with Schlüter anti-moisture seals.
- Electronic thermostatic control box included (2 ways).
- Stainless steel ceiling shower Ø 500 mm.
- Sliding bar with wall water intake. Length: 760 mm.
- Antilime hand shower.
- Shower hose SATIN.

Kit elettronico per doccia termostatico da incasso SHOWER TECHNOLOGY BLUE EDITION

- Controllo elettronico incluso con guarnizioni anti-umidità Schlüter.
- Centralina termostatica elettronica inclusa (2 vie).
- Soffione doccia acciaio inossidabile Ø 500 mm.
- Barra di scorrimento con presa d'acqua a parete. Lung. 760 mm.
- Doccetta anticalcare.
- Flessibile satin.

Termostatický podomítkový elektronický sprchový set SHOWER TECHNOLOGY BLUE EDITION

- Součásti kontrolní skříňka s těsněním od firmy Schlüter.
- Zabudovaná termostatická elektronická kontrolní jednotka (2-cestná).
- Stropní sprchové křepitko z nerez. oceli Ø 500 mm.
- Posuvná tyč s nástěnným přívodem vody. Délka 760 mm.
- Ruční sprcha, proti usaz. vod. kamene.
- Flexi hadice SATIN.



09286583

1.485,00



09288583

1.485,00



Built-in electronic thermostatic shower kit SHOWER TECHNOLOGY BLUE EDITION

- Electronic control included with Schlüter anti-moisture seals.
- Electronic thermostatic control box included (2 ways).
- Stainless steel ceiling shower Ø 380 mm.
- Sliding bar with ceiling shower intake. Length: 1,040 mm.
- Antilime hand shower.
- Shower hose SATIN.

Kit elettronico per doccia termostatica da incasso SHOWER TECHNOLOGY BLUE EDITION

- Controllo elettronico incluso con guarnizioni antimidità Schlüter.
- Centralina termostatica elettronica inclusa (2 vie).
- Soffione doccia acciaio inossidabile Ø 380 mm.
- Barra di scorrimento con presa d'acqua a soffitto. Lung. 1.040 mm
- Doccetta anticalcare.
- Flessibile satin.

Termostatický podomítkový elektronický sprchový set SHOWER TECHNOLOGY BLUE EDITION

- Součástí kontrolní skříňka s těsněním od firmy Schlüter.
- Zabudovaná termostatická elektronická kontrolní jednotka (2-cestná).
- Stropní sprchové křepítko z nerez. oceli Ø 380 mm.
- Posuvná tyč se stropním přívodem vody. Délka 1040 mm.
- Ruční sprcha, proti usaz. vod. kamene.
- Flexi hadice SATIN.

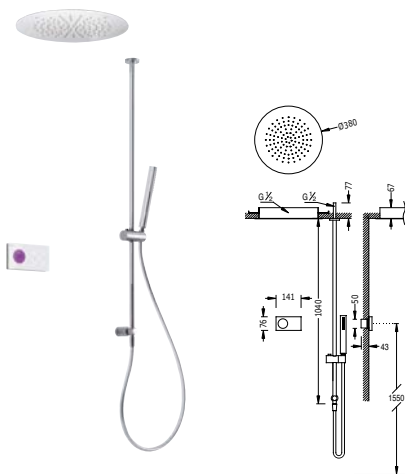

09286565

1.343,00



09288565

1.343,00



Built-in electronic thermostatic shower kit SHOWER TECHNOLOGY BLUE EDITION

- Electronic control included with Schlüter anti-moisture seals.
- Electronic thermostatic control box included (2 ways).
- Stainless steel ceiling shower Ø 500 mm.
- Elbow wall.
- Antilime hand shower.
- Shower hose SATIN.

Kit elettronico per doccia termostatica da incasso SHOWER TECHNOLOGY BLUE EDITION

- Controllo elettronico incluso con guarnizioni antimidità Schlüter.
- Centralina termostatica elettronica inclusa (2 vie).
- Soffione doccia acciaio inossidabile Ø 500 mm.
- Supporto per doccia.
- Doccetta anticalcare.
- Flessibile satin.

Termostatický podomítkový elektronický sprchový set SHOWER TECHNOLOGY BLUE EDITION

- Součástí kontrolní skříňka s těsněním od firmy Schlüter.
- Zabudovaná termostatická elektronická kontrolní jednotka (2-cestná).
- Stropní sprchové křepítko z nerez. oceli Ø 500 mm.
- Držák s nástěnným přívodem vody.
- Ruční sprcha, proti usaz. vod. kamene.
- Flexi hadice SATIN.

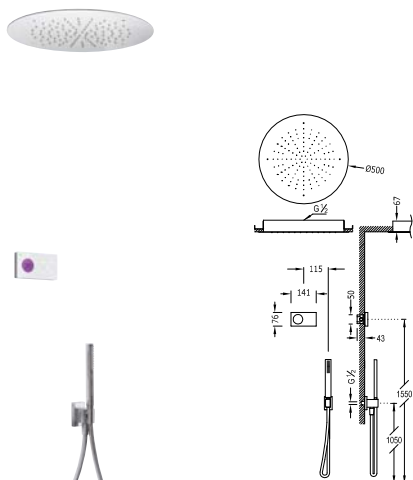

09286557

1.433,00

M 09286557BM

2.090,00

09286557AC

2.090,00



09288557

1.433,00

M 09288557NM

2.090,00

09288557AC

2.090,00



SHOWER TECH.



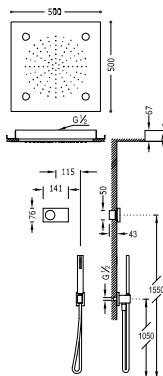

Built-in electronic thermostatic shower kit SHOWER TECHNOLOGY BLUE EDITION CHROMOTHERAPY

- Electronic control included with Schlüter anti-moisture seals.
- Electronic thermostatic control box included (2 ways).
- Ceiling shower antilime 500x500 mm.
- Elbow wall.
- Antilime hand shower.
- Shower hose SATIN.

Kit elettronico per doccia termostatico da incasso SHOWER TECHNOLOGY BLUE EDITION CHROMOTHERAPY

- Controllo elettronico incluso con guarnizioni anti-umidità Schlüter.
- Centralina termostatica elettronica inclusa (2 vie).
- Soffione doccia anticalcare 500x500 mm.
- Supporto per doccia.
- Doccetta anticalcare.
- Flessibile satin.

Termostatický podomítkový elektronický sprchový set SHOWER TECHNOLOGY BLUE EDITION CHROMOTHERAPY

- Součásti kontrolní skříňka s těsněním od firmy Schlüter.
- Zabudovaná termostatická elektronická kontrolní jednotka (2-cestná).
- Stropní sprchové křepitko z nerez. oceli 500x500 mm.
- Držák s nástěnným přívodem vody.
- Ruční sprcha, proti usaz. vod. kamene.
- Flexi hadice SATIN.



09286566

1.874,00



09288566

1.874,00

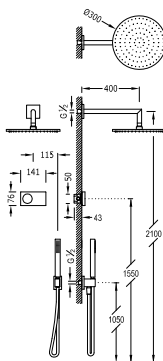

Built-in electronic thermostatic shower kit SHOWER TECHNOLOGY BLUE EDITION

- Electronic control included with Schlüter anti-moisture seals.
- Electronic thermostatic control box included (2 ways).
- Fixed shower head Ø 300 mm. with ball joint. Brass.
- Elbow wall.
- Antilime hand shower.
- Shower hose SATIN.

Kit elettronico per doccia termostatico da incasso SHOWER TECHNOLOGY BLUE EDITION

- Controllo elettronico incluso con guarnizioni anti-umidità Schlüter.
- Centralina termostatica elettronica inclusa (2 vie).
- Doccia fissa Ø 300 mm. con snodo. Ottone.
- Supporto per doccia.
- Doccetta anticalcare.
- Flessibile satin.

Termostatický podomítkový elektronický sprchový set SHOWER TECHNOLOGY BLUE EDITION

- Součásti kontrolní skříňka s těsněním od firmy Schlüter.
- Zabudovaná termostatická elektronická kontrolní jednotka (2-cestná).
- Pevná sprcha Ø 300 mm. s kloubem. Materiál Mosaz.
- Držák s nástěnným přívodem vody.
- Ruční sprcha, proti usaz. vod. kamene.
- Flexi hadice SATIN.



09286558

872,00

09286558BM

1.259,00

09286558AC

1.259,00



09288558

872,00

09288558NM

1.259,00

09288558AC

1.259,00



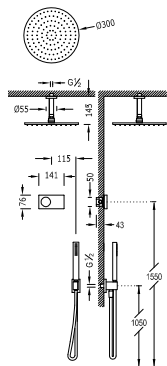

Built-in electronic thermostatic shower kit SHOWER TECHNOLOGY BLUE EDITION

- Electronic control included with Schlüter anti-moisture seals.
- Electronic thermostatic control box included (2 ways).
- Fixed shower head Ø 300 mm. with ball joint. Brass.
- Elbow wall.
- Antilime hand shower.
- Shower hose SATIN.

Kit elettronico per doccia termostatico da incasso SHOWER TECHNOLOGY BLUE EDITION

- Controllo elettronico incluso con guarnizioni anti-umidità Schlüter.
- Centralina termostatica elettronica inclusa (2 vie).
- Doccia fissa Ø 300 mm. con snodo. Ottone.
- Supporto per doccia.
- Doccetta anticalcare.
- Flessibile satin.

Termostatický podomítkový elektronický sprchový set SHOWER TECHNOLOGY BLUE EDITION

- Součástí kontrolní skříňka s těsněním od firmy Schlüter.
- Zabudovaná termostatická elektronická kontrolní jednotka (2-cestná).
- Pevná sprcha Ø 300 mm. s kloubem. Materiál Mosaz.
- Držák s nástěnným přívodem vody.
- Ruční sprcha, proti usaz. vod. kamene.
- Flexi hadice SATIN.



09286567 854,00

M 09286567BM 1.232,00

09286567AC 1.232,00



09288567 854,00

M 09288567NM 1.232,00

09288567AC 1.232,00



Built-in electronic thermostatic shower kit SHOWER TECHNOLOGY BLUE EDITION

- Electronic control included with Schlüter anti-moisture seals.
- Electronic thermostatic control box included (2 ways).
- Fixed shower head Ø 300 mm. with ball joint. Brass.
- Bar-shower antilime. long. 760 mm.
- Antilime hand shower.
- Shower hose SATIN.

Kit elettronico per doccia termostatico da incasso SHOWER TECHNOLOGY BLUE EDITION

- Controllo elettronico incluso con guarnizioni anti-umidità Schlüter.
- Centralina termostatica elettronica inclusa (2 vie).
- Doccia fissa Ø 300 mm. con snodo. Ottone.
- Asta anticivolo lunga 760 mm.
- Doccetta anticalcare.
- Flessibile satin.

Termostatický podomítkový elektronický sprchový set SHOWER TECHNOLOGY BLUE EDITION

- Součástí kontrolní skříňka s těsněním od firmy Schlüter.
- Zabudovaná termostatická elektronická kontrolní jednotka (2-cestná).
- Pevná sprcha Ø 300 mm. s kloubem. Materiál Mosaz.
- Posuvná tyč 760 mm.
- Ruční sprcha, proti usaz. vod. kamene.
- Flexi hadice SATIN.

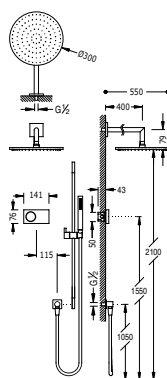

09286568 897,00



09288568 897,00



SHOWER TECH.

Built-in electronic thermostatic bath kit SHOWER TECHNOLOGY BLUE EDITION

- Electronic control included with Schlüter anti-moisture seals.
- Electronic thermostatic control box included (2 ways).
- Steel cascade cast spout.
- Elbow wall.
- Antilime hand shower.
- Shower hose SATIN.





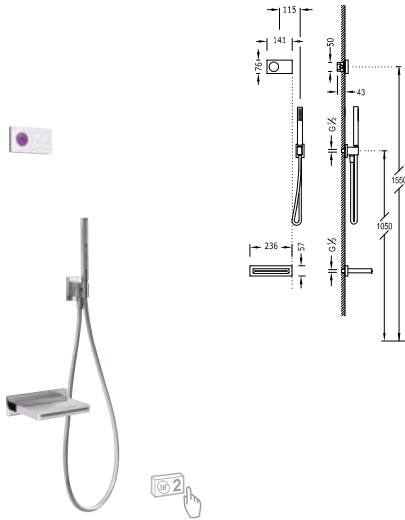

Kit elettronico per vasca da bagno termostatico da incasso SHOWER TECHNOLOGY BLUE EDITION

- Controllo elettronico incluso con guarnizioni antimidità Schlüter.
- Centralina termostatica elettronica inclusa (2 vie).
- Tubo cascata vasca acciaio inossidabile.
- Supporto per doccia.
- Doccetta anticalcare.
- Flessibile satin.

Termostatický podomítkový elektronický vanový set SHOWER TECHNOLOGY BLUE EDITION

- Součástí kontrolní skříňka s těsněním od firmy Schlüter.
- Zabudovaná termostatická elektronická kontrolní jednotka (2-cestná).
- Vanové ramínko s kaskádou z nerez. oceli.
- Držák s nástěnným přívodem vody.
- Ruční sprcha, proti usaz. vod. kamene.
- Flexi hadice SATIN.



	09286556	963,00
	09286556BM	1.401,00
	09286556AC	1.401,00
	09288556	963,00
	09288556NM	1.401,00
	09288556AC	1.401,00



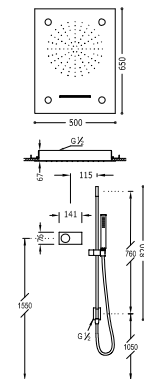

Built-in electronic thermostatic shower kit SHOWER TECHNOLOGY BLUE EDITION CHROMOTHERAPY

- Electronic control included with Schlüter anti-moisture seals.
- Electronic thermostatic control box included (3 ways).
- Stainless steel ceiling shower with 2 jet types 500x650 mm.
- Sliding bar with wall water intake. Length: 760 mm.
- Antilime hand shower.
- Shower hose SATIN.

IMPORTANT: Assemble a drain of >50 l/min.

Kit elettronico per doccia termostatica da incasso SHOWER TECHNOLOGY BLUE EDITION CHROMOTHERAPY

- Controllo elettronico incluso con guarnizioni anti-umidità Schlüter.
- Centralina termostatica elettronica inclusa (3 vie).
- Soffione doccia acciaio inossidabile con 2 tipi di getto 500x650 mm.
- Barra di scorrimento con presa d'acqua a parete. Lung. 760 mm.
- Doccetta anticalcare.
- Flessibile satin.

IMPORTANTE: Montare uno scarico di >50 l/min.

Termostatický podomítkový elektronický sprchový set SHOWER TECHNOLOGY BLUE EDITION CHROMOTHERAPY

- Součástí kontrolní skříňka s těsněním od firmy Schlüter.
- Zabudovaná termostatická elektronická kontrolní jednotka (3-cestná).
- Stropní sprchové křepitko z nerez. oceli s 2 typů proudění vody 500x650 mm.
- Posuvná tyč s nástěnným přívodem vody. Délka 760 mm.
- Ruční sprcha, proti usaz. vod. kamene.
- Flexi hadice SATIN.

DŮLEŽITÉ: Použijte odtokovou trubici pro průtok >50 l/min.



09286301

2.525,00



09288301

2.525,00

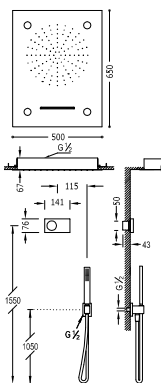

Built-in electronic thermostatic shower kit SHOWER TECHNOLOGY BLUE EDITION CHROMOTHERAPY

- Electronic control included with Schlüter anti-moisture seals.
- Electronic thermostatic control box included (3 ways).
- Stainless steel ceiling shower with 2 jet types 500x650 mm.
- Elbow wall.
- Antilime hand shower.
- Shower hose SATIN.

IMPORTANT: Assemble a drain of >50 l/min.

Kit elettronico per doccia termostatica da incasso SHOWER TECHNOLOGY BLUE EDITION CHROMOTHERAPY

- Controllo elettronico incluso con guarnizioni anti-umidità Schlüter.
- Centralina termostatica elettronica inclusa (3 vie).
- Soffione doccia acciaio inossidabile con 2 tipi di getto 500x650 mm.
- Supporto per doccia.
- Doccetta anticalcare.
- Flessibile satin.

IMPORTANTE: Montare uno scarico di >50 l/min.

Termostatický podomítkový elektronický sprchový set SHOWER TECHNOLOGY BLUE EDITION CHROMOTHERAPY

- Součástí kontrolní skříňka s těsněním od firmy Schlüter.
- Zabudovaná termostatická elektronická kontrolní jednotka (3-cestná).
- Stropní sprchové křepitko z nerez. oceli s 2 typů proudění vody 500x650 mm.
- Držák s nástěnným přívodem vody.
- Ruční sprcha, proti usaz. vod. kamene.
- Flexi hadice SATIN.

DŮLEŽITÉ: Použijte odtokovou trubici pro průtok >50 l/min.



09286302

2.472,00



09288302

2.472,00



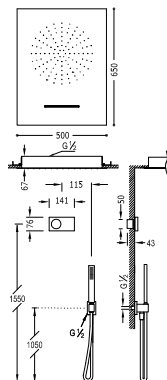

Built-in electronic thermostatic shower kit SHOWER TECHNOLOGY BLUE EDITION

- Electronic control included with Schlüter anti-moisture seals.
 - Electronic thermostatic control box included (3 ways).
 - Stainless steel ceiling shower with 2 jet types 500x650 mm.
 - Elbow wall.
 - Antilime hand shower.
 - Shower hose SATIN.
- IMPORTANT: Assemble a drain of >50 l/min.**

Kit elettronico per doccia termostatica da incasso SHOWER TECHNOLOGY BLUE EDITION

- Controllo elettronico incluso con guarnizioni antiumidità Schlüter.
 - Centralina termostatica elettronica inclusa (3 vie).
 - Soffione doccia acciaio inossidabile con 2 tipi di getto 500x650 mm.
 - Supporto per doccia.
 - Doccetta anticalcare.
 - Flessibile satin.
- IMPORTANTE: Montare uno scarico di >50 l/min.**

Termostatický podomítkový elektronický sprchový set SHOWER TECHNOLOGY BLUE EDITION

- Součástí kontrolní skříňka s těsněním od firmy Schlüter.
 - Zabudovaná termostatická elektronická kontrolní jednotka (3-cestná).
 - Stropní sprchové kropítko z nerez. oceli s 2 typů proudění vody 500x650 mm.
 - Držák s nástěnným přívodem vody.
 - Ruční sprcha, proti usaz. vod. kamene.
 - Flexi hadice SATIN.
- DŮLEŽITÉ: Použijte odtokovou trubici pro průtok >50 l/min.**



09286304

2.000,00



09288304

2.000,00



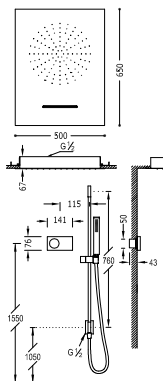

Built-in electronic thermostatic shower kit SHOWER TECHNOLOGY BLUE EDITION

- Electronic control included with Schlüter anti-moisture seals.
- Electronic thermostatic control box included (3 ways).
- Stainless steel ceiling shower with 2 jet types 500x650 mm.
- Sliding bar with wall water intake. Length: 760 mm.
- Antilime hand shower.
- Shower hose SATIN.

IMPORTANT: Assemble a drain of >50 l/min.

Kit elettronico per doccia termostatico da incasso SHOWER TECHNOLOGY BLUE EDITION

- Controllo elettronico incluso con guarnizioni anti-umidità Schlüter.
- Centralina termostatica elettronica inclusa (3 vie).
- Soffione doccia acciaio inossidabile con 2 tipi di getto 500x650 mm.
- Barra di scorrimento con presa d'acqua a parete. Lung. 760 mm.
- Doccetta anticalcare.
- Flessibile satin.

IMPORTANTE: Montare uno scarico di >50 l/min.

Termostatický podomítkový elektronický sprchový set SHOWER TECHNOLOGY BLUE EDITION

- Součástí kontrolní skříňka s těsněním od firmy Schlüter.
- Zabudovaná termostatická elektronická kontrolní jednotka (3-cestná).
- Stropní sprchové křepitko z nerez. oceli s 2 typů proudění vody 500x650 mm.
- Posuvná tyč s nástěnným přívodem vody. Délka 760 mm.
- Ruční sprcha, proti usaz. vod. kamene.
- Flexi hadice SATIN.

DŮLEŽITÉ: Použijte odtokovou trubici pro průtok >50 l/min.



09286303

2.053,00



09288303

2.053,00

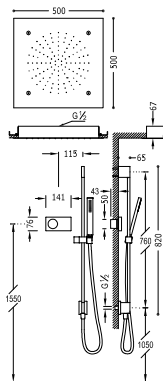

Built-in electronic thermostatic shower kit SHOWER TECHNOLOGY BLUE EDITION

- Electronic control included with Schlüter anti-moisture seals.
- Electronic thermostatic control box included (3 ways).
- Stainless steel ceiling shower with 2 jet types 500x500 mm.
- Sliding bar with wall water intake. Length: 760 mm.
- Antilime hand shower.
- Shower hose SATIN.

IMPORTANT: Assemble a drain of >50 l/min.

Kit elettronico per doccia termostatico da incasso SHOWER TECHNOLOGY BLUE EDITION

- Controllo elettronico incluso con guarnizioni anti-umidità Schlüter.
- Centralina termostatica elettronica inclusa (3 vie).
- Soffione doccia acciaio inossidabile con 2 tipi di getto 500x500 mm.
- Barra di scorrimento con presa d'acqua a parete. Lung. 760 mm.
- Doccetta anticalcare.
- Flessibile satin.

IMPORTANTE: Montare uno scarico di >50 l/min.

Termostatický podomítkový elektronický sprchový set SHOWER TECHNOLOGY BLUE EDITION

- Součástí kontrolní skříňka s těsněním od firmy Schlüter.
- Zabudovaná termostatická elektronická kontrolní jednotka (3-cestná).
- Stropní sprchové křepitko z nerez. oceli s 2 typů proudění vody 500x500 mm.
- Posuvná tyč s nástěnným přívodem vody. Délka 760 mm.
- Ruční sprcha, proti usaz. vod. kamene.
- Flexi hadice SATIN.

DŮLEŽITÉ: Použijte odtokovou trubici pro průtok >50 l/min.



09286305

1.694,00



09288305

1.694,00



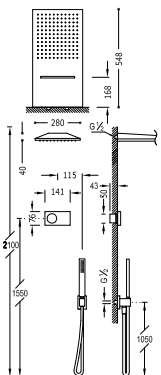

Built-in electronic thermostatic shower kit SHOWER TECHNOLOGY BLUE EDITION

- Electronic control included with Schlüter anti-moisture seals.
- Electronic thermostatic control box included (3 ways).
- Stainless steel wall shower with 2 jet types 280x50 mm.
- Elbow wall.
- Antilime hand shower.
- Shower hose SATIN.

IMPORTANT: Assemble a drain of >50 l/min.

Kit elettronico per doccia termostatico da incasso SHOWER TECHNOLOGY BLUE EDITION

- Controllo elettronico incluso con guarnizioni antimidità Schlüter.
- Centralina termostatica elettronica inclusa (3 vie).
- Doccia acciaio inossidabile da parete con 2 tipi di getto 280x50 mm.
- Supporto per doccia.
- Doccetta anticalcare.
- Flessibile satin.

IMPORTANTE: Montare uno scarico di >50 l/min.

Termostatický podomítkový elektronický sprchový set SHOWER TECHNOLOGY BLUE EDITION

- Součástí kontrolní skříňka s těsněním od firmy Schlüter.
- Zabudovaná termostatická elektronická kontrolní jednotka (3-cestná).
- Nástěnné sprchové křepítko z nerez. oceli s 2 typů proudění vody 280x50 mm.
- Držák s nástěnným přívodem vody.
- Ruční sprcha, proti usaz. vod. kamene.
- Flexi hadice SATIN.

DŮLEŽITÉ: Použijte odtokovou trubici pro průtok >50 l/min.



09286308 1.376,00

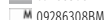

M 09286308BM 1.996,00



09286308AC 1.996,00



09288308 1.376,00



M 09288308NM 1.996,00



09288308AC 1.996,00

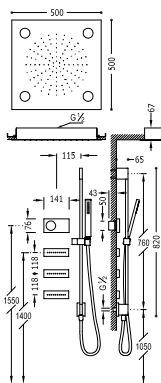

Built-in electronic thermostatic shower kit SHOWER TECHNOLOGY BLUE EDITION CHROMOTHERAPY

- Electronic control included with Schlüter anti-moisture seals.
- Electronic thermostatic control box included (3 ways).
- Stainless steel ceiling shower 500x500 mm.
- 3 antilime jets. Brass.
- Sliding bar with wall water intake. Length: 760 mm.
- Antilime hand shower.
- Shower hose SATIN.

IMPORTANT: Assemble a drain of >50 l/min.

Kit elettronico per doccia termostatico da incasso SHOWER TECHNOLOGY BLUE EDITION CHROMOTHERAPY

- Controllo elettronico incluso con guarnizioni antimidità Schlüter.
- Centralina termostatica elettronica inclusa (3 vie).
- Soffione doccia acciaio inossidabile 500x500 mm.
- 3 jets anticalcare. Ottone.
- Barra di scorrimento con presa d'acqua a parete. Lung. 760 mm.
- Doccetta anticalcare.
- Flessibile satin.

IMPORTANTE: Montare uno scarico di >50 l/min.

Termostatický podomítkový elektronický sprchový set SHOWER TECHNOLOGY BLUE EDITION CHROMOTHERAPY

- Součástí kontrolní skříňka s těsněním od firmy Schlüter.
- Zabudovaná termostatická elektronická kontrolní jednotka (3-cestná).
- Stropní sprchové křepítko z nerez. oceli 500x500 mm.
- 3 natáčení trysky, proti usaz. vod. kamene. Materiál Mosaz.
- Posuvná tyč s nástěnným přívodem vody. Délka 760 mm.
- Ruční sprcha, proti usaz. vod. kamene.
- Flexi hadice SATIN.

DŮLEŽITÉ: Použijte odtokovou trubici pro průtok >50 l/min.



09286309 2.436,00



09288309 2.436,00



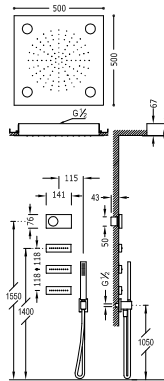

Built-in electronic thermostatic shower kit SHOWER TECHNOLOGY BLUE EDITION CHROMOTHERAPY

- Electronic control included with Schlüter anti-moisture seals.
- Electronic thermostatic control box included (3 ways).
- Stainless steel ceiling shower 500x500 mm.
- 3 antilime jets. Brass.
- Elbow wall.
- Antilime hand shower.
- Shower hose SATIN.

IMPORTANT: Assemble a drain of >50 l/min.

Kit elettronico per doccia termostatico da incasso SHOWER TECHNOLOGY BLUE EDITION CHROMOTHERAPY

- Controllo elettronico incluso con guarnizioni antimidità Schlüter.
- Centralina termostatica elettronica inclusa (3 vie).
- Soffione doccia acciaio inossidabile 500x500 mm.
- 3 jets anticalcare. Ottone.
- Supporto per doccia.
- Doccetta anticalcare.
- Flessibile satin.

IMPORTANTE: Montare uno scarico di >50 l/min.

Termostatický podomítkový elektronický sprchový set SHOWER TECHNOLOGY BLUE EDITION CHROMOTHERAPY

- Součástí kontrolní skříňka s těsněním od firmy Schlüter.
- Zabudovaná termostatická elektronická kontrolní jednotka (3-cestná).
- Sprchové křepítko z nerez. oceli 500x500 mm.
- 3 natáčeční trysky, proti usaz. vod. kamene. Materiál Mosaz.
- Držák s nástěnným přívodem vody.
- Ruční sprcha, proti usaz. vod. kamene.
- Flexi hadice SATIN.

DŮLEŽITÉ: Použijte odtokovou trubici pro průtok >50 l/min.

09286310 **2.382,00**

09288310 **2.382,00**



Built-in electronic thermostatic shower kit SHOWER TECHNOLOGY BLUE EDITION

- Electronic control included with Schlüter anti-moisture seals.
- Electronic thermostatic control box included (3 ways).
- Stainless steel ceiling shower 500x500 mm.
- 3 antilime jets. Brass.
- Sliding bar with wall water intake. Length: 760 mm.
- Antilime hand shower.
- Shower hose SATIN.

IMPORTANT: Assemble a drain of >50 l/min.

Kit elettronico per doccia termostatico da incasso SHOWER TECHNOLOGY BLUE EDITION

- Controllo elettronico incluso con guarnizioni antimidità Schlüter.
- Centralina termostatica elettronica inclusa (3 vie).
- Soffione doccia acciaio inossidabile 500x500 mm.
- 3 jets anticalcare. Ottone.
- Barra di scorrimento con presa d'acqua a parete. Lung. 760 mm.
- Doccetta anticalcare.
- Flessibile satin.

IMPORTANTE: Montare uno scarico di >50 l/min.

Termostatický podomítkový elektronický sprchový set SHOWER TECHNOLOGY BLUE EDITION

- Součástí kontrolní skříňka s těsněním od firmy Schlüter.
- Zabudovaná termostatická elektronická kontrolní jednotka (3-cestná).
- Stropní sprchové křepítko z nerez. oceli 500x500 mm.
- 3 natáčeční trysky, proti usaz. vod. kamene. Materiál Mosaz.
- Posuvná tyč s nástěnným přívodem vody. Délka 760 mm.
- Ruční sprcha, proti usaz. vod. kamene.
- Flexi hadice SATIN.

DŮLEŽITÉ: Použijte odtokovou trubici pro průtok >50 l/min.

09286311 **1.994,00**

09288311 **1.994,00**

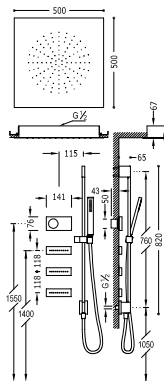

SHOWER TECH.

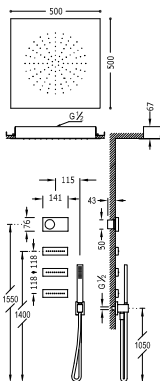

Built-in electronic thermostatic shower kit SHOWER TECHNOLOGY BLUE EDITION

- Electronic control included with Schlüter anti-moisture seals.
- Electronic thermostatic control box included (3 ways).
- Stainless steel ceiling shower 500x500 mm.
- 3 antilime jets. Brass.
- Elbow wall.
- Antilime hand shower.
- Shower hose SATIN.

IMPORTANT: Assemble a drain of >50 l/min.

Kit elettronico per doccia termostatico da incasso SHOWER TECHNOLOGY BLUE EDITION

- Controllo elettronico incluso con guarnizioni antiumidità Schlüter.
- Centralina termostatica elettronica inclusa (3 vie).
- Soffione doccia acciaio inossidabile 500x500 mm.
- 3 jets anticalcare. Ottone.
- Supporto per doccia.
- Doccetta anticalcare.
- Flessibile satin.

IMPORTANTE: Montare uno scarico di >50 l/min.

Termostatický podomítkový elektronický sprchový set SHOWER TECHNOLOGY BLUE EDITION

- Součásti kontrolní skříňka s těsněním od firmy Schlüter.
- Zabudovaná termostatická elektronická kontrolní jednotka (3-cestná).
- Stropní sprchové křepítko z nerez. oceli 500x500 mm.
- 3 natáčecí trysky, proti usaz. vod. kamene. Materiál Mosaz.
- Držák s nástěnným přívodem vody.
- Ruční sprcha, proti usaz. vod. kamene.
- Flexi hadice SATIN.

DŮLEŽITÉ: Použijte odtokovou trubici pro průtok >50 l/min.



	09286312	1.942,00
	09286312BM	2.826,00
	09286312AC	2.826,00



	09288312	1.942,00
	09288312NM	2.826,00
	09288312AC	2.826,00

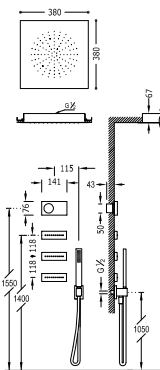

Built-in electronic thermostatic shower kit SHOWER TECHNOLOGY BLUE EDITION

- Electronic control included with Schlüter anti-moisture seals.
- Electronic thermostatic control box included (3 ways).
- Stainless steel ceiling shower 380x380 mm.
- 3 antilime jets. Brass.
- Elbow wall.
- Antilime hand shower.
- Shower hose SATIN.

IMPORTANT: Assemble a drain of >50 l/min.

Kit elettronico per doccia termostatico da incasso SHOWER TECHNOLOGY BLUE EDITION

- Controllo elettronico incluso con guarnizioni antiumidità Schlüter.
- Centralina termostatica elettronica inclusa (3 vie).
- Soffione doccia acciaio inossidabile 380x380 mm.
- 3 jets anticalcare. Ottone.
- Supporto per doccia.
- Doccetta anticalcare.
- Flessibile satin.

IMPORTANTE: Montare uno scarico di >50 l/min.

Termostatický podomítkový elektronický sprchový set SHOWER TECHNOLOGY BLUE EDITION

- Součásti kontrolní skříňka s těsněním od firmy Schlüter.
- Zabudovaná termostatická elektronická kontrolní jednotka (3-cestná).
- Stropní sprchové křepítko z nerez. oceli 380x380 mm.
- 3 natáčecí trysky, proti usaz. vod. kamene. Materiál Mosaz.
- Držák s nástěnným přívodem vody.
- Ruční sprcha, proti usaz. vod. kamene.
- Flexi hadice SATIN.

DŮLEŽITÉ: Použijte odtokovou trubici pro průtok >50 l/min.



	09286313	1.740,00
	09286313BM	2.531,00
	09286313AC	2.531,00



	09288313	1.740,00
	09288313NM	2.531,00
	09288313AC	2.531,00



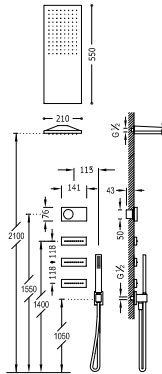

Built-in electronic thermostatic shower kit SHOWER TECHNOLOGY BLUE EDITION

- Electronic control included with Schlüter anti-moisture seals.
 - Electronic thermostatic control box included (3 ways).
 - Stainless steel wall shower 210x550 mm.
 - 3 antilime jets. Brass.
 - Elbow wall.
 - Antilime hand shower.
 - Shower hose SATIN.
- IMPORTANT:** Assemble a drain of >50 l/min.

Kit elettronico per doccia termostatica da incasso SHOWER TECHNOLOGY BLUE EDITION

- Controllo elettronico incluso con guarnizioni antimidità Schlüter.
 - Centralina termostatica elettronica inclusa (3 vie).
 - Doccia acciaio inossidabile da parete 210x550 mm.
 - 3 jets anticalcare. Otton.
 - Supporto per doccia.
 - Doccetta anticalcare.
 - Flessibile satin.
- IMPORTANTE:** Montare uno scarico di >50 l/min.

Termostatický podomítkový elektronický sprchový set SHOWER TECHNOLOGY BLUE EDITION

- Součástí kontrolní skříňka s těsněním od firmy Schlüter.
- Zabudovaná termostatická elektronická kontrolní jednotka (3-cestná).
- Nástěnné sprchové křepítko z nerez. oceli 210x550 mm.
- 3 natáčetci trysky, proti usaz. vod. kamene. Materiál Mosaz.
- Držák s nástěnným přívodem vody.
- Ruční sprcha, proti usaz. vod. kamene.
- Flexi hadice SATIN.

DŮLEŽITÉ: Použijte odtokovou trubici pro průtok >50 l/min.

	09286314	1.539,00
	M 09286314BM	2.217,00
	09286314AC	2.217,00

	09288314	1.539,00
	M 09288314NM	2.217,00
	09288314AC	2.217,00

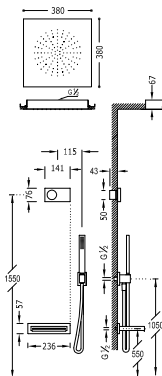

Built-in electronic thermostatic bath kit SHOWER TECHNOLOGY BLUE EDITION

- Electronic control included with Schlüter anti-moisture seals.
 - Electronic thermostatic control box included (3 ways).
 - Stainless steel ceiling shower 380x380 mm.
 - Steel cascade cast spout.
 - Elbow wall.
 - Antilime hand shower.
 - Shower hose SATIN.
- IMPORTANT:** Assemble a drain of >50 l/min.

Kit elettronico per vasca da bagno termostatico da incasso SHOWER TECHNOLOGY BLUE EDITION

- Controllo elettronico incluso con guarnizioni antimidità Schlüter.
 - Centralina termostatica elettronica inclusa (3 vie).
 - Soffione doccia acciaio inossidabile 380x380 mm.
 - Tubo cascata vasca acciaio inossidabile.
 - Supporto per doccia.
 - Doccetta anticalcare.
 - Flessibile satin.
- IMPORTANTE:** Montare uno scarico di >50 l/min.

Termostatický podomítkový elektronický vanový set SHOWER TECHNOLOGY BLUE EDITION

- Součástí kontrolní skříňka s těsněním od firmy Schlüter.
- Zabudovaná termostatická elektronická kontrolní jednotka (3-cestná).
- Stropní sprchové křepítko z nerez. oceli 380x380 mm.
- Vanové ramínko s kaskádou z nerez. oceli.
- Držák s nástěnným přívodem vody.
- Ruční sprcha, proti usaz. vod. kamene.
- Flexi hadice SATIN.

DŮLEŽITÉ: Použijte odtokovou trubici pro průtok >50 l/min.

	09286315	1.606,00
	M 09286315BM	2.332,00
	09286315AC	2.332,00

	09288315	1.606,00
	M 09288315NM	2.332,00
	09288315AC	2.332,00



SHOWER TECH.

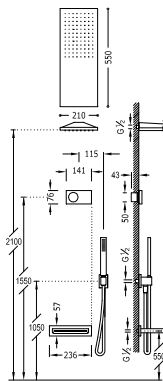

Built-in electronic thermostatic bath kit SHOWER TECHNOLOGY BLUE EDITION

- Electronic control included with Schlüter anti-moisture seals.
- Electronic thermostatic control box included (3 ways).
- Stainless steel wall shower 210x550 mm.
- Steel cascade cast spout.
- Elbow wall.
- Antilime hand shower.
- Shower hose SATIN.

IMPORTANT: Assemble a drain of >50 l/min.

Kit elettronico per vasca da bagno termostatico da incasso SHOWER TECHNOLOGY BLUE EDITION

- Controllo elettronico incluso con guarnizioni anti-umidità Schlüter.
- Centralina termostatica elettronica inclusa (3 vie).
- Doccia acciaio inossidabile da parete 210x550 mm.
- Tubo cascata vasca acciaio inossidabile.
- Supporto per doccia.
- Doccetta anticalcare.
- Flessibile satin.

IMPORTANTE: Montare uno scarico di >50 l/min.

Termostatický podomítkový elektronický vanový set SHOWER TECHNOLOGY BLUE EDITION

- Součástí kontrolní skříňka s těsněním od firmy Schlüter.
- Zabudovaná termostatická elektronická kontrolní jednotka (3-cestná).
- Nástěnné sprchové křepítko z nerez. oceli 210x550 mm.
- Vanové ramínko s kaskádou z nerez. oceli.
- Držák s nástěnným přívodem vody.
- Ruční sprcha, proti usaz. vod. kamene.
- Flexi hadice SATIN.

DŮLEŽITÉ: Použijte odtokovou trubici pro průtok >50 l/min.



09286316

1.404,00

M 09286316BM

2.019,00

09286316AC

2.019,00



09288316

1.404,00

09288316NM

2.019,00

09288316AC

2.019,00



Built-in electronic thermostatic bath kit SHOWER TECHNOLOGY BLUE EDITION

- Electronic control included with Schlüter anti-moisture seals.
- Electronic thermostatic control box included (3 ways).
- Stainless steel ceiling shower 380x380 mm.
- Bath drain and square CASCADE filling valve with overflow drain.
- Bath PVC drain trap.
- Elbow wall.
- Antilime hand shower.
- Shower hose SATIN.

Kit elettronico per vasca da bagno termostatico da incasso SHOWER TECHNOLOGY BLUE EDITION

- Controllo elettronico incluso con guarnizioni anti-umidità Schlüter.
- Centralina termostatica elettronica inclusa (3 vie).
- Soffione doccia acciaio inossidabile 380x380 mm.
- Scarico vasca e valvola di riempimento quadrata A CASCATA con troppopieno.
- Sifone PVC vasca.
- Supporto per doccia.
- Doccetta anticalcare.
- Flessibile satin.

Termostatický podomítkový elektronický vanový set SHOWER TECHNOLOGY BLUE EDITION

- Součástí kontrolní skříňka s těsněním od firmy Schlüter.
- Zabudovaná termostatická elektronická kontrolní jednotka (3-cestná).
- Stropní sprchové křepítko z nerez. oceli 380x380 mm.
- Odtoková a napouštěcí vanová hranata KASKÁDA s přeřadem.
- Vanový sifon z PVC.
- Držák s nástěnným přívodem vody.
- Ruční sprcha, proti usaz. vod. kamene.
- Flexi hadice SATIN.

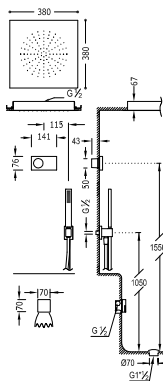

09286317

1.346,00



09288317

1.346,00



Built-in electronic thermostatic bath kit SHOWER TECHNOLOGY BLUE EDITION

- Electronic control included with Schlüter anti-moisture seals.
- Electronic thermostatic control box included (3 ways).
- Stainless steel wall shower 210x550 mm.
- Bath drain and square CASCADE filling valve with overflow drain.
- Bath PVC drain trap.
- Elbow wall.
- Antilime hand shower.
- Shower hose SATIN.

Kit elettronico per vasca da bagno termostatico da incasso SHOWER TECHNOLOGY BLUE EDITION

- Controllo elettronico incluso con guarnizioni antimidità Schlüter.
- Centralina termostatica elettronica inclusa (3 vie).
- Doccia acciaio inossidabile da parete 210x550 mm.
- Scarico vasca e valvola di riempimento quadrata A CASCATA con troppopieno.
- Sifone PVC vasca.
- Supporto per doccia.
- Doccetta anticalcare.
- Flessibile satin.

Termostatický podomítkový elektronický vanový set SHOWER TECHNOLOGY BLUE EDITION

- Součásti kontrolní skříňka s těsněním od firmy Schlüter.
- Zabudovaná termostatická elektronická kontrolní jednotka (3-cestná).
- Nástěnné sprchové křepítko z nerez. oceli 210x550 mm.
- Odtoková a napouštěcí vanová hranata KASKÁDA s přepadem.
- Vanový sifon z PVC.
- Držák s nástěnným přívodem vody.
- Ruční sprcha, proti usaz. vod. kamene.
- Flexi hadice SATIN.

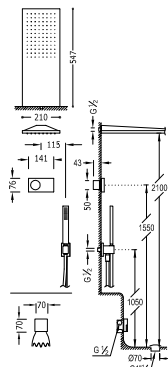

09286318 1.143,00

09288318 1.143,00



Built-in electronic thermostatic bath kit SHOWER TECHNOLOGY BLUE EDITION

- Electronic control included with Schlüter anti-moisture seals.
- Electronic thermostatic control box included (3 ways).
- Stainless steel wall shower 210x550 mm.
- Steel cascade cast spout.
- Elbow wall.
- Antilime hand shower.
- Shower hose SATIN.

IMPORTANT: Assemble a drain of >50 l/min.

Kit elettronico per vasca da bagno termostatico da incasso SHOWER TECHNOLOGY BLUE EDITION

- Controllo elettronico incluso con guarnizioni antimidità Schlüter.
- Centralina termostatica elettronica inclusa (3 vie).
- Doccia acciaio inossidabile da parete 210x550 mm.
- Tubo cascata vasca acciaio inossidabile.
- Supporto per doccia.
- Doccetta anticalcare.
- Flessibile satin.

IMPORTANTE: Montare uno scarico di >50 l/min.

Termostatický podomítkový elektronický vanový set SHOWER TECHNOLOGY BLUE EDITION

- Součásti kontrolní skříňka s těsněním od firmy Schlüter.
- Zabudovaná termostatická elektronická kontrolní jednotka (3-cestná).
- Nástěnné sprchové křepítko z nerez. oceli 210x550 mm.
- Vanové ramínko s kaskádou z nerez. oceli.
- Držák s nástěnným přívodem vody.
- Ruční sprcha, proti usaz. vod. kamene.
- Flexi hadice SATIN.

DŮLEŽITÉ: Použijte odtokovou trubici pro průtok >50 l/min.

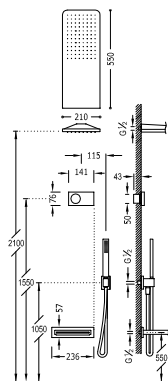

09286319 1.485,00
 M 09286319BM 2.134,00
 09286319AC 2.134,00

09288319 1.485,00
 M 09288319NM 2.134,00
 09288319AC 2.134,00



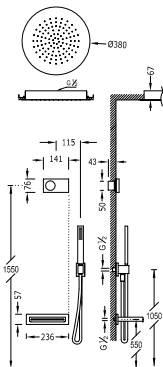

Built-in electronic thermostatic bath kit SHOWER TECHNOLOGY BLUE EDITION

- Electronic control included with Schlüter anti-moisture seals.
- Electronic thermostatic control box included (3 ways).
- Stainless steel ceiling shower Ø 380 mm.
- Steel cascade cast spout.
- Elbow wall.
- Antilime hand shower.
- Shower hose SATIN.

IMPORTANT: Assemble a drain of >50 l/min.

Kit elettronico per vasca da bagno termostatico da incasso SHOWER TECHNOLOGY BLUE EDITION

- Controllo elettronico incluso con guarnizioni anti-umidità Schlüter.
- Centralina termostatica elettronica inclusa (3 vie).
- Soffione doccia acciaio inossidabile Ø 380 mm.
- Tubo cascata vasca acciaio inossidabile.
- Supporto per doccia.
- Doccetta anticalcare.
- Flessibile satin.

IMPORTANTE: Montare uno scarico di >50 l/min.

Termostatický podomítkový elektronický vanový set SHOWER TECHNOLOGY BLUE EDITION

- Součástí kontrolní skříňka s těsněním od firmy Schlüter.
- Zabudovaná termostatická elektronická kontrolní jednotka (3-cestná).
- Stropní sprchové křepitko z nerez. oceli Ø 380 mm.
- Vanové ramínko s kaskádou z nerez. oceli.
- Držák s nástěnným přívodem vody.
- Ruční sprcha, proti usaz. vod. kamene.
- Flexi hadice SATIN.

DŮLEŽITÉ: Použijte odtokovou trubici pro průtok >50 l/min.



09286320

1.662,00

M 09286320BM

2.403,00

09286320AC

2.403,00



09288320

1.662,00

09288320NM

2.403,00

09288320AC

2.403,00

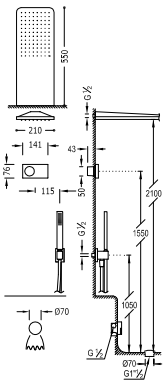

Built-in electronic thermostatic bath kit SHOWER TECHNOLOGY BLUE EDITION

- Electronic control included with Schlüter anti-moisture seals.
- Electronic thermostatic control box included (3 ways).
- Stainless steel wall shower 210x550 mm.
- Bath drain and round CASCADE filling valve with overflow drain.
- Bath PVC drain trap.
- Elbow wall.
- Antilime hand shower.
- Shower hose SATIN.

Kit elettronico per vasca da bagno termostatico da incasso SHOWER TECHNOLOGY BLUE EDITION

- Controllo elettronico incluso con guarnizioni anti-umidità Schlüter.
- Centralina termostatica elettronica inclusa (3 vie).
- Doccia acciaio inossidabile da parete 210x550 mm.
- Scarico vasca e valvola di riempimento rotonda A CASCATA con troppopieno.
- Sifone PVC vasca.
- Supporto per doccia.
- Doccetta anticalcare.
- Flessibile satin.

Termostatický podomítkový elektronický vanový set SHOWER TECHNOLOGY BLUE EDITION

- Součástí kontrolní skříňka s těsněním od firmy Schlüter.
- Zabudovaná termostatická elektronická kontrolní jednotka (3-cestná).
- Nástěnné sprchové křepitko z nerez. oceli 210x550 mm.
- Odtoková a napouštěcí vanová kulatá KASKÁDA s přepadem.
- Vanový sifon z PVC.
- Držák s nástěnným přívodem vody.
- Ruční sprcha, proti usaz. vod. kamene.
- Flexi hadice SATIN.



09286321

1.189,00



09288321

1.189,00



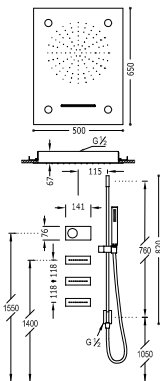

Built-in electronic thermostatic shower kit SHOWER TECHNOLOGY BLUE EDITION CHROMOTHERAPY

- Electronic control included with Schlüter anti-moisture seals.
- Electronic thermostatic control box included (4 ways).
- Stainless steel ceiling shower with 2 jet types 500x650 mm.
- 3 antilime jets. Brass.
- Sliding bar with wall water intake. Length: 760 mm.
- Antilime hand shower.
- Shower hose SATIN.

IMPORTANT: Assemble a drain of >50 l/min.

Kit elettronico per doccia termostatica da incasso SHOWER TECHNOLOGY BLUE EDITION CHROMOTHERAPY

- Controllo elettronico incluso con guarnizioni anti-umidità Schlüter.
- Centralina termostatica elettronica inclusa (4 vie).
- Soffione doccia acciaio inossidabile con 2 tipi di getto 500x650 mm.
- 3 jets anticalcare. Ottone.
- Barra di scorrimento con presa d'acqua a parete. Lung. 760 mm.
- Doccetta anticalcare.
- Flessibile satin.

IMPORTANTE: Montare uno scarico di >50 l/min.

Termostatický podomítkový elektronický sprchový set SHOWER TECHNOLOGY BLUE EDITION CHROMOTHERAPY

- Součásti kontrolní skříňka s těsněním od firmy Schlüter.
- Zabudovaná termostatická elektronická kontrolní jednotka (4-cestná).
- Stropní sprchové křepítko z nerez. oceli s 2 typů proudění vody 500x650 mm.
- 3 natáčecí trysky, proti usaz. vod. kamene. Materiál Mosaz.
- Posuvná tyč s nástěnným přívodem vody. Délka 760 mm.
- Ruční sprcha, proti usaz. vod. kamene.
- Flexní hadice SATIN.

DŮLEŽITÉ: Použijte odtokovou trubici pro průtok >50 l/min.



3.018,00



3.018,00

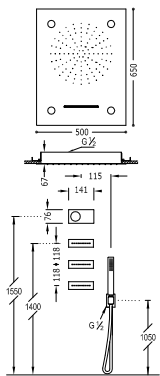

Built-in electronic thermostatic shower kit SHOWER TECHNOLOGY BLUE EDITION CHROMOTHERAPY

- Electronic control included with Schlüter anti-moisture seals.
- Electronic thermostatic control box included (4 ways).
- Stainless steel ceiling shower with 2 jet types 500x650 mm.
- 3 antilime jets. Brass.
- Elbow wall.
- Antilime hand shower.
- Shower hose SATIN.

IMPORTANT: Assemble a drain of >50 l/min.

Kit elettronico per doccia termostatica da incasso SHOWER TECHNOLOGY BLUE EDITION CHROMOTHERAPY

- Controllo elettronico incluso con guarnizioni anti-umidità Schlüter.
- Centralina termostatica elettronica inclusa (4 vie).
- Soffione doccia acciaio inossidabile con 2 tipi di getto 500x650 mm.
- 3 jets anticalcare. Ottone.
- Supporto per doccia.
- Doccetta anticalcare.
- Flessibile satin.

IMPORTANTE: Montare uno scarico di >50 l/min.

Termostatický podomítkový elektronický sprchový set SHOWER TECHNOLOGY BLUE EDITION CHROMOTHERAPY

- Součásti kontrolní skříňka s těsněním od firmy Schlüter.
- Zabudovaná termostatická elektronická kontrolní jednotka (4-cestná).
- Stropní sprchové křepítko z nerez. oceli s 2 typů proudění vody 500x650 mm.
- 3 natáčecí trysky, proti usaz. vod. kamene. Materiál Mosaz.
- Držák s nástěnným přívodem vody.
- Ruční sprcha, proti usaz. vod. kamene.
- Flexní hadice SATIN.

DŮLEŽITÉ: Použijte odtokovou trubici pro průtok >50 l/min.



2.965,00



2.965,00



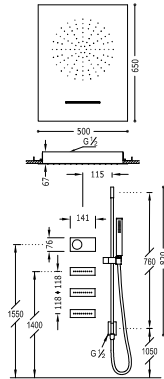

Built-in electronic thermostatic shower kit SHOWER TECHNOLOGY BLUE EDITION

- Electronic control included with Schlüter anti-moisture seals.
- Electronic thermostatic control box included (4 ways).
- Stainless steel ceiling shower with 2 jet types 500x650 mm.
- 3 antilime jets. Brass.
- Sliding bar with wall water intake. Length: 760 mm.
- Antilime hand shower.
- Shower hose SATIN.

IMPORTANT: Assemble a drain of >50 l/min.

Kit elettronico per doccia termostatica da incasso SHOWER TECHNOLOGY BLUE EDITION

- Controllo elettronico incluso con guarnizioni antimidità Schlüter.
- Centralina termostatica elettronica inclusa (4 vie).
- Soffione doccia acciaio inossidabile con 2 tipi di getto 500x650 mm.
- 3 jets anticalcare. Ottone.
- Barra di scorrimento con presa d'acqua a parete. Lung. 760 mm.
- Doccetta anticalcare.
- Flessibile satin.

IMPORTANTE: Montare uno scarico di >50 l/min.

Termostatický podomítkový elektronický sprchový set SHOWER TECHNOLOGY BLUE EDITION

- Součástí kontrolní skříňka s těsněním od firmy Schlüter.
- Zabudovaná termostatická elektronická kontrolní jednotka (4-cestná).
- Stropní sprchové křepítka z nerez. oceli s 2 typů proudění vody 500x650 mm.
- 3 natáčecí trysky, proti usaz. vod. kamene. Materiál Mosaz.
- Posuvná tyč s nástěnným přívodem vody. Délka 760 mm.
- Ruční sprcha, proti usaz. vod. kamene.
- Flexi hadice SATIN.

DŮLEŽITÉ: Použijte odtokovou trubici pro průtok >50 l/min.

	09286403	2.546,00
	M 09286403BM	3.700,00
	09286403AC	3.700,00

	09288403	2.546,00
	M 09288403NM	3.700,00
	09288403AC	3.700,00

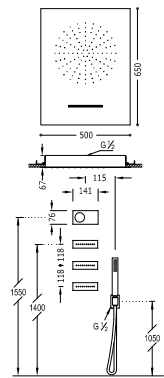

Built-in electronic thermostatic shower kit SHOWER TECHNOLOGY BLUE EDITION

- Electronic control included with Schlüter anti-moisture seals.
- Electronic thermostatic control box included (4 ways).
- Stainless steel ceiling shower with 2 jet types 500x650 mm.
- 3 antilime jets. Brass.
- Elbow wall.
- Antilime hand shower.
- Shower hose SATIN.

IMPORTANT: Assemble a drain of >50 l/min.

Kit elettronico per doccia termostatica da incasso SHOWER TECHNOLOGY BLUE EDITION

- Controllo elettronico incluso con guarnizioni antimidità Schlüter.
- Centralina termostatica elettronica inclusa (4 vie).
- Soffione doccia acciaio inossidabile con 2 tipi di getto 500x650 mm.
- 3 jets anticalcare. Ottone.
- Supporto per doccia.
- Doccetta anticalcare.
- Flessibile satin.

IMPORTANTE: Montare uno scarico di >50 l/min.

Termostatický podomítkový elektronický sprchový set SHOWER TECHNOLOGY BLUE EDITION

- Součástí kontrolní skříňka s těsněním od firmy Schlüter.
- Zabudovaná termostatická elektronická kontrolní jednotka (4-cestná).
- Stropní sprchové křepítka z nerez. oceli s 2 typů proudění vody 500x650 mm.
- 3 natáčecí trysky, proti usaz. vod. kamene. Materiál Mosaz.
- Držák s nástěnným přívodem vody.
- Ruční sprcha, proti usaz. vod. kamene.
- Flexi hadice SATIN.

DŮLEŽITÉ: Použijte odtokovou trubici pro průtok >50 l/min.

	09286404	2.494,00
	M 09286404BM	3.637,00
	09286404AC	3.637,00

	09288404	2.494,00
	M 09288404NM	3.637,00
	09288404AC	3.637,00



SHOWER TECH.

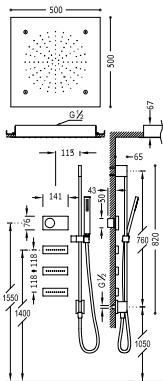

Built-in electronic thermostatic shower kit SHOWER TECHNOLOGY BLUE EDITION

- Electronic control included with Schlüter anti-moisture seals.
- Electronic thermostatic control box included (4 ways).
- Stainless steel ceiling shower with 2 jet types 500x500 mm.
- 3 antilime jets. Brass.
- Sliding bar with wall water intake. Length: 760 mm.
- Antilime hand shower.
- Shower hose SATIN.

IMPORTANT: Assemble a drain of >50 l/min.

Kit elettronico per doccia termostatica da incasso SHOWER TECHNOLOGY BLUE EDITION

- Controllo elettronico incluso con guarnizioni antimidità Schlüter.
- Centralina termostatica elettronica inclusa (4 vie).
- Soffione doccia acciaio inossidabile con 2 tipi di getto 500x500 mm.
- 3 jets anticalcare. Ottone.
- Barra di scorrimento con presa d'acqua a parete. Lung. 760 mm.
- Doccetta anticalcare.
- Flessibile satin.

IMPORTANTE: Montare uno scarico di >50 l/min.

Termostatický podomítkový elektronický sprchový set SHOWER TECHNOLOGY BLUE EDITION

- Součásti kontrolní skříňka s těsněním od firmy Schlüter.
- Zabudovaná termostatická elektronická kontrolní jednotka (4-cestná).
- Stropní sprchové křepítko z nerez. oceli s 2 typů proudění vody 500x500 mm.
- 3 natáčecí trysky, proti usaz. vod. kamene. Materiál Mosaz.
- Posuvná tyč s nástěnným přívodem vody. Délka 760 mm.
- Ruční sprcha, proti usaz. vod. kamene.
- Flexní hadice SATIN.

DŮLEŽITÉ: Použijte odtokovou trubici pro průtok >50 l/min.



09286405

2.188,00



09288405

2.188,00

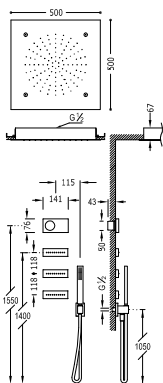

Built-in electronic thermostatic shower kit SHOWER TECHNOLOGY BLUE EDITION

- Electronic control included with Schlüter anti-moisture seals.
- Electronic thermostatic control box included (4 ways).
- Stainless steel ceiling shower with 2 jet types 500x500 mm.
- 3 antilime jets. Brass.
- Elbow wall.
- Antilime hand shower.
- Shower hose SATIN.

IMPORTANT: Assemble a drain of >50 l/min.

Kit elettronico per doccia termostatica da incasso SHOWER TECHNOLOGY BLUE EDITION

- Controllo elettronico incluso con guarnizioni antimidità Schlüter.
- Centralina termostatica elettronica inclusa (4 vie).
- Soffione doccia acciaio inossidabile con 2 tipi di getto 500x500 mm.
- 3 jets anticalcare. Ottone.
- Supporto per doccia.
- Doccetta anticalcare.
- Flessibile satin.

IMPORTANTE: Montare uno scarico di >50 l/min.

Termostatický podomítkový elektronický sprchový set SHOWER TECHNOLOGY BLUE EDITION

- Součásti kontrolní skříňka s těsněním od firmy Schlüter.
- Zabudovaná termostatická elektronická kontrolní jednotka (4-cestná).
- Stropní sprchové křepítko z nerez. oceli s 2 typů proudění vody 500x500 mm.
- 3 natáčecí trysky, proti usaz. vod. kamene. Materiál Mosaz.
- Držák s nástěnným přívodem vody.
- Ruční sprcha, proti usaz. vod. kamene.
- Flexní hadice SATIN.

DŮLEŽITÉ: Použijte odtokovou trubici pro průtok >50 l/min.



09286406

2.134,00



09288406

2.134,00





Built-in electronic thermostatic shower kit SHOWER TECHNOLOGY BLUE EDITION

- Electronic control included with Schlüter anti-moisture seals.
- Electronic thermostatic control box included (4 ways).
- Stainless steel wall shower with 2 jet types 280x550 mm.
- 3 antilime jets. Brass.
- Sliding bar with wall water intake. Length: 760 mm.
- Antilime hand shower.
- Shower hose SATIN.

IMPORTANT: Assemble a drain of >50 l/min.

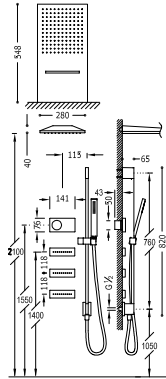

Kit elettronico per doccia termostatica da incasso SHOWER TECHNOLOGY BLUE EDITION

- Controllo elettronico incluso con guarnizioni antimidità Schlüter.
- Centralina termostatica elettronica inclusa (4 vie).
- Doccia acciaio inossidabile da parete con 2 tipi di getto 280x550 mm.
- 3 jets anticalcare. Ottone.
- Barra di scorrimento con presa d'acqua a parete. Lung. 760 mm.
- Doccetta anticalcare.
- Flessibile satin.

IMPORTANTE: Montare uno scarico di >50 l/min.

Termostatický podomítkový elektronický sprchový set SHOWER TECHNOLOGY BLUE EDITION

- Součástí kontrolní skříňka s těsněním od firmy Schlüter.
- Zabudovaná termostatická elektronická kontrolní jednotka (4-cestná).
- Nástěnné sprchové křepítka z nerez. oceli s 2 typů proudění vody 280x550 mm.
- 3 natáčeč trysky, proti usaz. vod. kamene. Materiál Mosaz.
- Posuvná tyč s nástěnným přívodem vody. Délka 760 mm.
- Ruční sprcha, proti usaz. vod. kamene.
- Flexi hadice SATIN.

DŮLEŽITÉ: Použijte odtokovou trubici pro průtok >50 l/min.

	09286407	1.923,00
	M 09286407BM	2.785,00
	09286407AC	2.785,00

	09288407	1.923,00
	M 09288407NM	2.785,00
	09288407AC	2.785,00



Built-in electronic thermostatic shower kit SHOWER TECHNOLOGY BLUE EDITION

- Electronic control included with Schlüter anti-moisture seals.
- Electronic thermostatic control box included (4 ways).
- Stainless steel wall shower with 2 jet types 280x550 mm.
- 3 antilime jets. Brass.
- Elbow wall.
- Antilime hand shower.
- Shower hose SATIN.

IMPORTANT: Assemble a drain of >50 l/min.

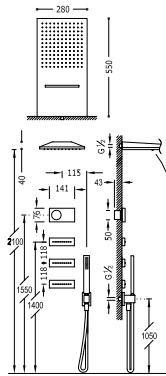

Kit elettronico per doccia termostatica da incasso SHOWER TECHNOLOGY BLUE EDITION

- Controllo elettronico incluso con guarnizioni antimidità Schlüter.
- Centralina termostatica elettronica inclusa (4 vie).
- Doccia acciaio inossidabile da parete con 2 tipi di getto 280x550 mm.
- 3 jets anticalcare. Ottone.
- Supporto per doccia.
- Doccetta anticalcare.
- Flessibile satin.

IMPORTANTE: Montare uno scarico di >50 l/min.

Termostatický podomítkový elektronický sprchový set SHOWER TECHNOLOGY BLUE EDITION

- Součástí kontrolní skříňka s těsněním od firmy Schlüter.
- Zabudovaná termostatická elektronická kontrolní jednotka (4-cestná).
- Nástěnné sprchové křepítka z nerez. oceli s 2 typů proudění vody 280x550 mm.
- 3 natáčeč trysky, proti usaz. vod. kamene. Materiál Mosaz.
- Držák s nástěnným přívodem vody.
- Ruční sprcha, proti usaz. vod. kamene.
- Flexi hadice SATIN.

DŮLEŽITÉ: Použijte odtokovou trubici pro průtok >50 l/min.

	(1) 09286408	1.871,00
	(1) M 09286408BM	2.722,00
	(1) 09286408AC	2.722,00

	(1) 09288408	1.871,00
	M 09288408NM	2.722,00
	09288408AC	2.722,00



SHOWER TECH.

284 / **Bathtub mixer taps** | Monocomando esterno | *Jednopákový mechanizmus vany*



286 / **Built-in sets** | Monocomando ad incasso | *Vestavěné soupravy*



MONO-TERM



www.qrtr.es/mono-term



MONO
TERM



**Chrome
Cromato**
Chrom



Matt Black
Nero Opaco
Černá mat



Matt White
Bianco Opaco
Bílá mat



Steel
Acciaio
Ocel



Touch-cool technology
The surface of the tap remains at a temperature suitable for touching, thus preventing burns.

Tecnologia Touch-cool
La superficie del rubinetto si mantiene a una temperatura che permette di toccarlo senza scottarsi.

Technologie Touch-cool
Povrch baterie je stále příjemně chladný, proto se jí lze kdykoliv dotknout bez obav z opaření.



MONO-TERM

Advanced mixer taps

Rubinetti monocomando avanzati

Vyspělé jednopákové systémy

Installing a Mono-term® tap in your shower or bathtub has many advantages. It offers the same comfort in use as any other mixer tap but also includes advanced technology with features similar to those of a thermostatic tap.

Utilizzare un rubinetto Mono-term® nella vostra doccia o vasca da bagno ha molti vantaggi. La stessa facilità d'uso di qualsiasi altro monocomando ma con una tecnologia avanzata che offre delle prestazioni simili a quelle di un gruppo termostatico.

Použití baterie Mono-term® ve Vaší vaně či sprše má mnoho výhod. Stejně jednoduché použití jako u jakékoliv jiné jednopákové baterie, ale s vyspělejší technologií, přinášející charakteristiky podobné baterii termostatické.



Precision

The large swivel angle of the handle allows the flow and the desired temperature to be smoothly and effortlessly regulated at the same time.

Precisione

Il grande angolo di rotazione della manopola consente di regolare allo stesso tempo, delicatamente, il flusso e la temperatura desiderati con esattezza e senza sforzi.

Přesnost

Velký úhel otáčení páky zároveň umožňuje jemnou, přesnou a snadnou regulaci průtoku a požadované teploty.



Reliability

With no filters or non-return valves and suitable for hard waters (limestone, sand...).

Affidabilità

Senza filtri né valvole antiritorno, è adatta per acque dure (calcare, sabbiolina...).

Spolehlivost

Bez filtrů ani zpětných ventilů, jsou zcela vhodné pro tvrdou vodu (vodní kámen, písek...).



Safety

The temperature remains constant in the presence of pressure or temperature changes ($\pm 2^\circ\text{C}$).

Sicurezza

La temperatura si mantiene costante in caso di variazioni di pressione o temperatura ($\pm 2^\circ\text{C}$).

Bezpečnost

Udržuje konstantní teplotu i přes výkyvy tlaku a teploty ($\pm 2^\circ\text{C}$).



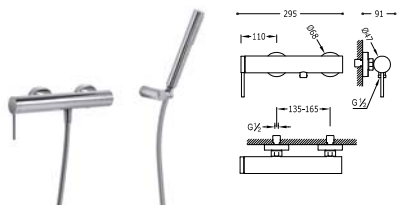

MONO-TERM® Single lever shower mixer
Anti-limescale hand shower with directable support and satin hose.

MONO-TERM® doccia
Doccetta anticalcare con supporto orientabile. Flessibile satin.

MONO-TERM® sprchová baterie
Ruční sprcha s nastavitelným držákem, proti usaz. vod. kamene a flexi hadice SATIN.



06216801

240,00

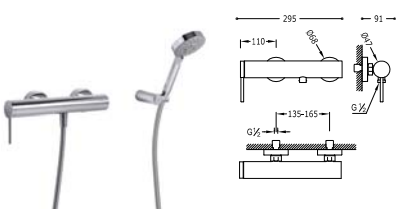

MONO-TERM® Single lever shower mixer
Massage hand shower Ø 100 mm. (5 fonctions) with directable support and satin hose.

MONO-TERM® doccia
Doccia mobile Ø 100 mm. (5 funzioni) con supporto orientabile e flessibile satin.

MONO-TERM® sprchová baterie
Ruční masážní sprcha Ø 100 mm. (5 funkcí) s nastavitelným držákem. Flexi hadice SATIN.



20116701

238,00

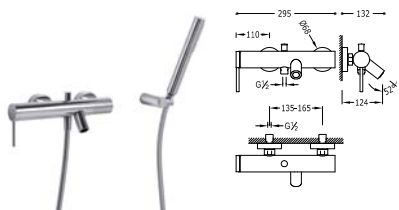

MONO-TERM® Single lever bath and shower mixer
Anti-limescale hand shower with directable support and satin hose.

MONO-TERM® vasca
Doccetta anticalcare con supporto orientabile. Flessibile satin.

MONO-TERM® baterie pro vanu-sprchu
Ruční sprcha s nastavitelným držákem, proti usaz. vod. kamene a flexi hadice SATIN.



06217801

292,00

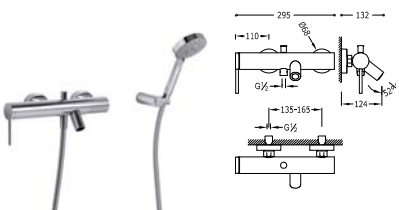

MONO-TERM® Single lever bath and shower mixer
Massage hand shower Ø 100 mm. (5 fonctions) with directable support and satin hose.

MONO-TERM® vasca
Doccia mobile Ø 100 mm. (5 funzioni) con supporto orientabile e flessibile satin.

MONO-TERM® baterie pro vanu-sprchu
Ruční masážní sprcha Ø 100 mm. (5 funkcí) s nastavitelným držákem. Flexi hadice SATIN.



20117001

289,00



Bar-shower MONO-TERM® set

- Fixed shower head Ø 300 mm. with ball joint. Brass.
- Anti-limescale hand shower.
- Shower hose SATIN.
- Telescopic bar.

Set doccia MONO-TERM®

- Doccia fissa Ø 300 mm. con snodo. Ottone.
- Doccetta anticalcare.
- Flessibile satin.
- Asta telescopica.

Sprchová tyč MONO-TERM®

- Pevná sprcha Ø 300 mm. s kloubem. Materiál Mosaz.
- Ruční sprcha, proti usaz. vod. kámenem.
- Flexi hadice SATIN.
- Teleskopická tyč.

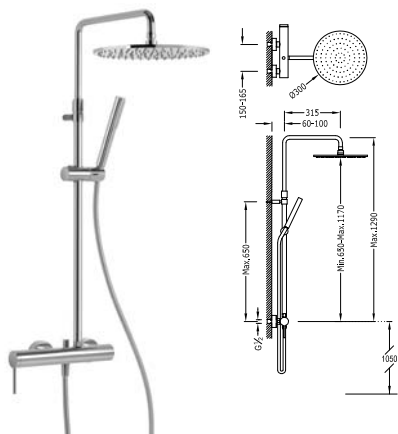

06237801

543,00

Bar-shower MONO-TERM® set

- Fixed shower head Ø 250 mm. with ball joint.
- Massage hand shower Ø 100 mm. (5 functions).
- Shower hose SATIN.
- Telescopic bar.

Set doccia MONO-TERM®

- Doccia fissa Ø 250 mm. con snodo.
- Doccia mobile massaggio Ø 100 mm. (5 funzioni).
- Flessibile satin.
- Asta telescopica.

Sprchová tyč MONO-TERM®

- Pevná sprcha Ø 250 mm. s kloubem.
- Ruční masážní sprcha Ø 100 mm. (5 funkci).
- Flexi hadice SATIN.
- Teleskopická tyč.



20119501

517,00



Built-in MONO-TERM® (1 way)
with water shut off and flow control.
· Built-in body included

MONO-TERM® da incasso (1 via)
Con chiusura e regolazione di portata.
· Corpo incassato incluso

Baterie MONO-TERM® (jednocestný)
s uzávěrem a regulací průtoku.
· Včetně podomítkového tělesa

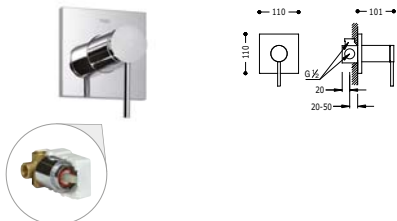

20117701

136,00

Built-in MONO-TERM® (2 way)
with water shut off and flow control.
· Built-in body included

MONO-TERM® da incasso (2 vie)
Con chiusura e regolazione di portata.
· Corpo incassato incluso

Baterie MONO-TERM® (dvoucestný)
s uzávěrem a regulací průtoku.
· Včetně podomítkového tělesa

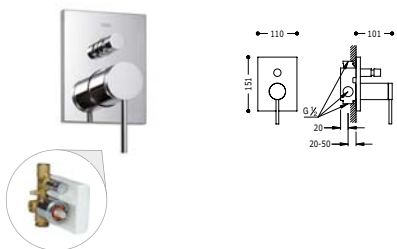

20118001

188,00

20118001AC

310,00

20118001NM

310,00

20118001BM

310,00

Built-in MONO-TERM® (1 way)
with water shut off and flow control.
· Built-in body included

MONO-TERM® da incasso (1 via)
Con chiusura e regolazione di portata.
· Corpo incassato incluso

Baterie MONO-TERM® (jednocestný)
s uzávěrem a regulací průtoku.
· Včetně podomítkového tělesa

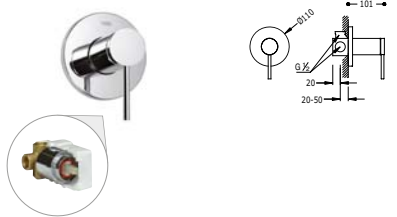

20117702

126,00

Built-in MONO-TERM® (2 way)
with water shut off and flow control.
· Built-in body included

MONO-TERM® da incasso (2 vie)
Con chiusura e regolazione di portata.
· Corpo incassato incluso

Baterie MONO-TERM® (dvoucestný)
s uzávěrem a regulací průtoku.
· Včetně podomítkového tělesa

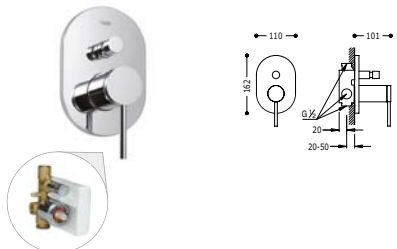

20118002

176,00

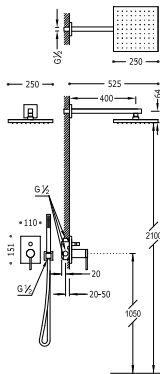

Built-in MONO-TERM® for showers

- with water shut off and flow control.
- Built-in body included
- Fixed shower head 250x250 mm. with ball joint.
- Elbow wall.
- Anti-limescale hand shower.
- Shower hose SATIN.

Kit MONO-TERM® da incasso doccia

- Con chiusura e regolazione di portata.
- Corpo incassato incluso
- Doccia fissa 250x250 mm. con snodo.
- Supporto per doccia.
- Doccia anticalcare.
- Flessibile satin.

Sprchová sada podomítková MONO-TERM®

- s uzávěrem a regulací průtoku.
- Včetně podomítkového tělesa
- Pevná sprcha 250x250 mm. s kloubem.
- Držák s nástěnným přívodem vody.
- Ruční sprcha, proti usaz. vod. kamene.
- Flexi hadice SATIN.



20118006

410,00

MONO
TERM

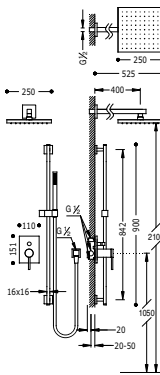

Built-in MONO-TERM® for showers

- with water shut off and flow control.
- Built-in body included
- Fixed shower head 250x250 mm. with ball joint.
- Sliding bar long. 842 mm.
- Elbow wall.
- Anti-limescale hand shower.
- Shower hose SATIN.

Kit MONO-TERM® da incasso doccia

- Con chiusura e regolazione di portata.
- Corpo incassato incluso
- Doccia fissa 250x250 mm. con snodo.
- Asta anticivolo lunga 842 mm.
- Presa a parete.
- Doccia anticalcare.
- Flessibile satin.

Sprchová sada podomítková MONO-TERM®

- s uzávěrem a regulací průtoku.
- Včetně podomítkového tělesa
- Pevná sprcha 250x250 mm. s kloubem.
- Posuvná tyč 842 mm.
- Kolínko nást. přívodem.
- Ruční sprcha, proti usaz. vod. kamene.
- Flexi hadice SATIN.



20118007

503,00

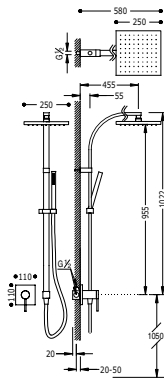

- Built-in MONO-TERM® for showers with water shut off and flow control.**
- Built-in body included
 - Fixed shower head 250x250 mm. with ball joint.
 - Anti-limescale hand shower.
 - Shower hose SATIN.
 - With wall entrance.

- Kit MONO-TERM® da incasso doccia**
Con chiusura e regolazione di portata.
- Corpo incassato incluso
 - Doccia fissa 250x250 mm. con snodo.
 - Douchette anticalcaire.
 - Flessibile satin.
 - Con presa a parete.

- Sprchová sada podomítková MONO-TERM®**
s uzávěrem a regulací průtoku.
- Včetně podomítkového tělesa
 - Pevná sprcha 250x250 mm. s kloubem.
 - Ruční sprcha, proti usaz. vod. kamene.
 - Flexi hadice SATIN.
 - S nástěnným přívodem.



20117704

385,00

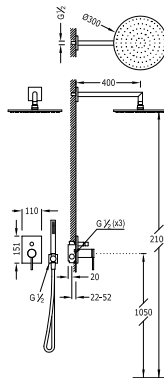

- Built-in MONO-TERM® for showers with water shut off and flow control.**
- Built-in body included
 - Fixed shower head Ø 300 mm. with ball joint. Brass.
 - Elbow wall.
 - Anti-limescale hand shower.
 - Shower hose SATIN.

- Kit MONO-TERM® da incasso doccia**
Con chiusura e regolazione di portata.
- Corpo incassato incluso
 - Doccia fissa Ø 300 mm. con snodo. Ottone.
 - Supporto per doccia.
 - Doccia anticalcare .
 - Flessibile satin.

- Sprchová sada podomítková MONO-TERM®**
s uzávěrem a regulací průtoku.
- Včetně podomítkového tělesa
 - Pevná sprcha Ø 300 mm. s kloubem. Materiál mosaz.
 - Držák s nástěnným přívodem vody.
 - Ruční sprcha, proti usaz. vod. kamene.
 - Flexi hadice SATIN.



06218003

455,00

06218003AC

752,00

06218003NM

752,00

06218003BM

752,00

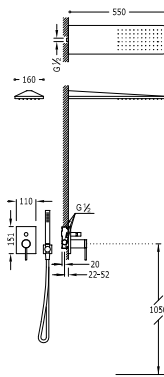

- Built-in MONO-TERM® for showers with water shut off and flow control.**
- Built-in body included
 - Stainless steel shower 160x550 mm.
 - Elbow wall.
 - Anti-limescale hand shower.
 - Shower hose SATIN.

- Kit MONO-TERM® da incasso doccia**
Con chiusura e regolazione di portata.
- Corpo incassato incluso
 - Doccia acciaio inossidabile 160x550 mm.
 - Supporto per doccia.
 - Doccia anticalcare.
 - Flessibile satin.

- Sprchová sada podomítková MONO-TERM®**
s uzávěrem a regulací průtoku.
- Včetně podomítkového tělesa
 - Sprcha z nerez. oceli 160x550 mm.
 - Držák s nástěnným přívodem vody.
 - Ruční sprcha, proti usaz. vod. kamene.
 - Flexi hadice SATIN.



06218010

626,00

06218010AC

1.034,00

06218010NM

1.034,00

06218010BM

1.034,00



Built-in MONO-TERM® for showers

- with water shut off and flow control.
- Built-in body included
- Stainless steel shower with cascade 152x200 mm.
- Elbow wall.
- Anti-limescale hand shower.
- Shower hose SATIN.

Kit MONO-TERM® da incasso doccia

- Con chiusura e regolazione di portata.
- Corpo incassato incluso
- Doccia acciaio inossidabile con cascata 152x200 mm.
- Supporto per doccia.
- Doccia anticalcare.
- Flessibile satin.

Sprchová sada podomítková MONO-TERM®

- s uzávěrem a regulací průtoku.
- Včetně podomítkového tělesa
- Sprcha z nerez. oceli s kaskádou 152x200 mm.
- Držák s nástěnným přívodem vody.
- Ruční sprcha, proti usaz. vod. kamene.
- Flexi hadice SATIN.

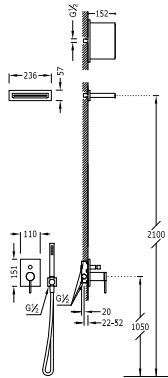

06218006

534,00



Built-in MONO-TERM® for showers

- with water shut off and flow control.
- Built-in body included
- Fixed shower head Ø 300 mm. with ball joint. Brass.
- Bar-shower Anti-limescale. long. 673 mm.
- Elbow wall.
- Anti-limescale hand shower.
- Shower hose SATIN.

Kit MONO-TERM® da incasso doccia

- Con chiusura e regolazione di portata.
- Corpo incassato incluso
- Doccia fissa Ø 300 mm. con snodo. Ottone.
- Asta anticivolo lunga 673 mm.
- Pressa a parete.
- Doccia anticalcare.
- Flessibile satin.

Sprchová sada podomítková MONO-TERM®

- s uzávěrem a regulací průtoku.
- Včetně podomítkového tělesa
- Pevná sprcha Ø 300 mm. s kloubem. Materiál mosaz.
- Kolínko nástěnným přívodem.
- Posuvná tyč délky 673 mm.
- Ruční sprcha, proti usaz. vod. kamene.
- Flexi hadice SATIN.

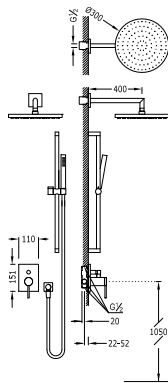

06218007

464,00



Built-in MONO-TERM® for showers

- with water shut off and flow control.
- Built-in body included
- Fixed shower head Ø 300 mm. with ball joint. Brass.
- Anti-limescale hand shower.
- Shower hose SATIN.
- With wall entrance.

Kit MONO-TERM® da incasso doccia

- Con chiusura e regolazione di portata.
- Corpo incassato incluso
- Doccia fissa Ø 300 mm. con snodo. Ottone.
- Doccia anticalcare.
- Flessibile satin.
- Con presa a parete.

Sprchová sada podomítková MONO-TERM®

- s uzávěrem a regulací průtoku.
- Včetně podomítkového tělesa
- Pevná sprcha Ø 300 mm. s kloubem. Materiál mosaz.
- Ruční sprcha, proti usaz. vod. kamene.
- Flexi hadice SATIN.
- S nástěnným přívodem.

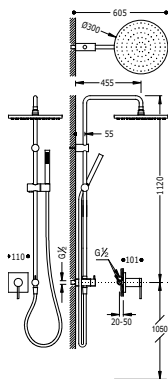

06218008

414,00



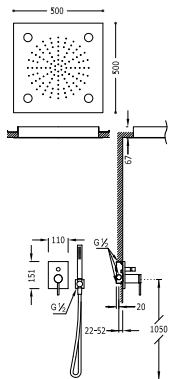

Built-in MONO-TERM® for showers CHROMOTHERAPY with water shut off and flow control.

- Built-in body included
- Ceiling shower Anti-limescale 500x500 mm.
- Elbow wall.
- Anti-limescale hand shower.
- Shower hose SATIN.

Kit MONO-TERM® da incasso doccia CHROMOTHERAPY

Con chiusura e regolazione di portata.

- Corpo incassato incluso
- Soffione doccia anticalcare 500x500 mm.
- Supporto per doccia.
- Doccia anticalcare.
- Flessibile satin.

Sprchová sada podomítková MONO-TERM® CHROMOTHERAPY

s uzávěrem a regulací průtoku.

- Včetně podomítkového tělesa
- Stropní sprchové křepítko z nerez. oceli 500x500 mm.
- Držák s nástěnným přívodem vody.
- Ruční sprcha, proti usaz. vod. kamene.
- Flexi hadice SATIN.



06218011

1.324,00

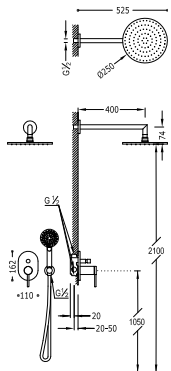

Built-in MONO-TERM® for showers with water shut off and flow control.

- Built-in body included
- Fixed shower head Ø 250 mm. with ball joint.
- Elbow wall.
- Massage hand shower Ø 100 mm. (5 fonctions).
- Shower hose SATIN.

Kit MONO-TERM® da incasso doccia

con chiusura e regolazione di portata.

- Corpo incassato incluso
- Doccia fissa Ø 250 mm. con snodo.
- Supporto per doccia.
- Doccia mobile Ø 100 mm. (5 funzioni).
- Flessibile satin.

Sprchová sada podomítková MONO-TERM®

s uzávěrem a regulací průtoku.

- Včetně podomítkového tělesa
- Pevná sprcha Ø 250 mm. s kloubem.
- Držák s nástěnným přívodem vody.
- Ruční masážní sprcha Ø 100 mm (5 funkcí).
- Flexi hadice SATIN.



20118003

364,00

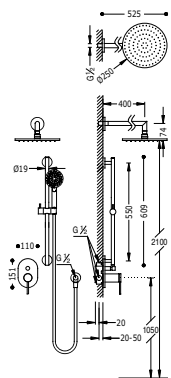

Built-in MONO-TERM® for showers with water shut off and flow control.

- Built-in body included
- Fixed shower head Ø 250 mm. with ball joint.
- Sliding bar long. 550 mm.
- Elbow wall.
- Massage hand shower Ø 100 mm. (5 fonctions).
- Shower hose SATIN.

Kit MONO-TERM® da incasso doccia

con chiusura e regolazione di portata.

- Corpo incassato incluso
- Doccia fissa Ø 250 mm. con snodo.
- Asta antiscivolo lunga 550 mm.
- Presa a parete.
- Doccia mobile Ø 100 mm. (5 funzioni).
- Flessibile satin.

Sprchová sada podomítková MONO-TERM®

s uzávěrem a regulací průtoku.

- Včetně podomítkového tělesa
- Pevná sprcha Ø 250 mm. s kloubem.
- Posuvná tyč 550 mm.
- Kolínko nást. přívodem.
- Ruční masážní sprcha Ø 100 mm (5 funkcí).
- Flexi hadice SATIN.



20118004

398,00

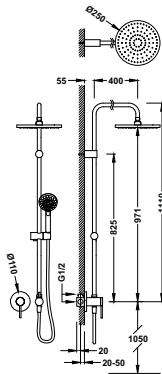

- Built-in MONO-TERM® for showers**
with water shut off and flow control.
- Built-in body included
 - Fixed shower head Ø 250 mm. with ball joint.
 - Hand shower Ø 100 mm. (5 fonctions).
 - Shower hose SATIN.
 - With wall entrance.

- Kit MONO-TERM® da incasso doccia**
con chiusura e regolazione di portata.
- Corpo incassato incluso
 - Doccia fissa Ø 250 mm. con snodo.
 - Doccia mobile Ø 100 mm. (5 funzioni).
 - Flessibile satin.
 - Con presa a parete.

- Sprchová sada podomítková MONO-TERM® s uzávěrem a regulací průtoku.*
- Včetně podomítkového tělesa
 - Pevná sprcha Ø 250 mm. s kloubem.
 - Ruční masážní sprcha Ø 100 mm. (5 funkcí).
 - Flexi hadice SATIN.
 - S nástěnným přívodem.



20117703

292,00

- Built-in MONO-TERM® for bathtubs-showers**
with water shut off and flow control. (2 ways).
- Bath drain and round CASCADE filling valve with overflow drain.
 - Bath PVC drain trap.
 - Massage hand shower Ø 100 mm. (5 fonctions).
 - Double interlocked shower hose.

- MONO-TERM® da incasso bagno-doccia**
Con chiusura e regolazione di portata. (2 vie).
- Scarico vasca e valvola di riempimento rotonda A CASCATA con troppopieno.
 - Sifone PVC vasca.
 - Doccia massaggio Ø 100 mm. (5 funzioni).
 - Flessibile doppia graffatura.

- Baterie pro vanu-sprchu podomítková MONO-TERM® s uzávěrem a regulací průtoku (2-cestná).*
- Odtoková a napouštěcí vanová kulatá souprava KASKÁDA s přepladem.
 - Vanový sifon z PVC.
 - Ruční masážní sprcha Ø 100 mm. (5 funkcí).
 - Flexi hadice s dvojitým zámkem.

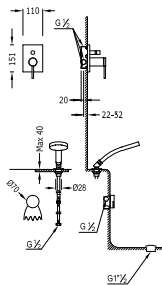

06218012

386,00

- Built-in MONO-TERM® for bathtubs-showers**
with water shut off and flow control. (2 ways).
- Bath drain and round CASCADE filling valve with overflow drain.
 - Bath PVC drain trap.
 - Elbow wall.
 - Massage hand shower Ø 100 mm. (5 fonctions).
 - Shower hose SATIN.

- MONO-TERM® da incasso bagno-doccia**
Con chiusura e regolazione di portata. (2 vie).
- Scarico vasca e valvola di riempimento rotonda A CASCATA con troppopieno.
 - Sifone PVC vasca.
 - Supporto per doccia.
 - Doccia massaggio Ø 100 mm. (5 funzioni).
 - Flessibile satin.

- Baterie pro vanu-sprchu podomítková MONO-TERM® s uzávěrem a regulací průtoku (2-cestná).*
- Odtoková a napouštěcí vanová kulatá souprava KASKÁDA s přepladem.
 - Vanový sifon z PVC.
 - Držák s nástěnným přívodem vody.
 - Ruční masážní sprcha Ø 100 mm. (5 funkcí).
 - Flexi hadice SATIN.

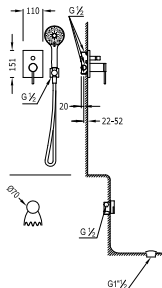

06218013

295,00

296 / Built-in sets | Monocomando ad incasso | Vestavěné soupravy

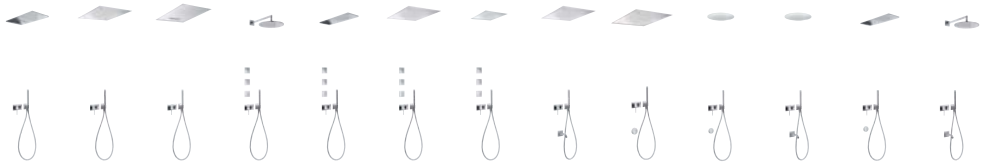



Chrome
Cromato
Chrom



Matt Black
Nero Opaco
Černá mat



Matt White
Bianco Opaco
Bílá mat



Steel
Acciaio
Ocel



Gold 24K
Oro 24K
Zlato 24K



Matt gold 24K
Oro 24K Opaco
Zlato 24K mat

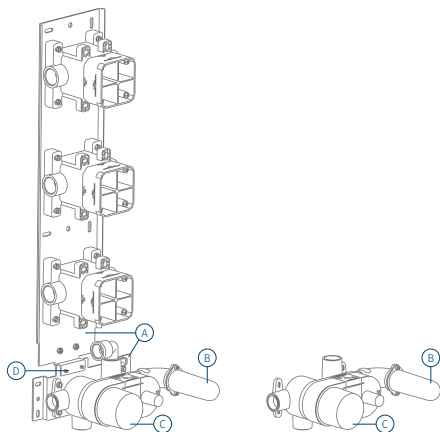

Easy to install
Facile da installare
Snadná instalace

- (A) **Wall-mounted or plasterboard installation profile with a leveling system.** / Profilo di installazione a parete o cartongesso livellabile.
/ Profil pro upevnění na zed' či sádrokarton s vyvážením.
- (B) **Base with built-in shower connection and watertight protector.** / Supporto con attacco doccia integrato e protettore a tenuta.
/ Integrovaný nosník se sprchovým talířem a ochranou proti vniknutí vody.
- (C) **Detachable protector. External notch to protect the chrome-plated parts.** / Protettore estraibile. Taglio esterno per proteggere le parti cromate.
/ Výsuvná ochrana. Vnější seříznutí kvůli ochraně chromovaných částí.
- (D) **Perfect alignment thanks to the fastening between the central body and the jets by means of profiles.** / Allineamento perfetto grazie all'ancoraggio tra corpo centrale e bocchette tramite profili.
/ Dokonalé seříznutí díky ukotvení mezi hlavním tělesem a tryskami prostřednictvím profilů.

3V

The most complete shower

La doccia piÙ completa

Nejkompletnější sprcha

Mixer taps are characterized by their functionality. This flush-mounted mixer tap range is no exception and adds beauty and simplicity to its design, with the important benefit of having 3 different water outlets.

I monocomandi si caratterizzano per la loro funzionalità. Questa gamma da incasso di monocomandi non vi rinuncia, aggiungendo bellezza e semplicità al design, con il grande vantaggio di offrire 3 vie distinte per l'uscita d'acqua.

Jednopákové baterie jsou charakteristické svojí funkcí. Tato řada vestavěných jednopákových baterií na funkčnost nerezignuje a díky svému designu přináší lepší estetiku a jednoduchost. Má tu výhodu, že nabízí 3 různé výstupy vody (3v).



Function selector

Selettore di funzioni

Volba funkcí

- ① A single handle opens and closes the water flow, adjusts the temperature and regulates the flow rate. / Un solo comando apre e chiude il flusso d'acqua, regola la temperatura e il flusso. / Jednou pákou se otevírá/zavírá proud vody, nastavuje teplotu i reguluje průtok.
- ② A function selector allows you to choose any of the three possible water outlets. / Di fianco, vi è un selettore di funzioni che consente di scegliere una delle tre possibili uscite dell'acqua. / MMimoto lze použít volič funkcí k výběru jakéhokoli ze tří výstupů vody.



Built-in installation

The head and shower supports are integrated in a single built-in unit in the kits.

Installazione da incasso

Nei kit, il controllo e il supporto doccia sono integrati in un solo corpo incassato non divisibile.

Vestavěná instalace

U sad je ovládání a sprchový držák zabudován do jednoho vestavěného nerozdělitelného tělesa.

3V

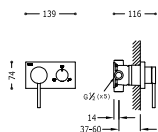

Built-in mixer taps 3V
 - Built-in body included (3 ways).

Monocomando incasso 3V
 - Corpo incassato incluso (3 vie).

Vestavěná jednopáková baterie 3V
 - Včetně podomítkového tělesa (3-cestná).



	21027399	318,00
	21027399NM	525,00
	21027399BM	525,00
	21027399AC	525,00
	21027399OR	637,00
	21027399OM	637,00

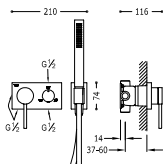

Built-in mixer taps 3V
 - Built-in body included (3 ways).
 - Anti-limescale hand shower.
 - Elbow wall.
 - Shower hose SATIN.

Monocomando incasso 3V
 - Corpo incassato incluso (3 vie)

- Doccetta anticalcare.
 - Supporto per doccia.
 - Flessibile satin.

Vestavěná jednopáková baterie 3V
 - Včetně podomítkového tělesa (3-cestná)
 - Držák s nástěnným přívozem vody.
 - Ruční sprcha, proti usaz. vod. kamene.
 - Flexi hadice SATIN.



	21027391	424,00
	21027391NM	700,00
	21027391BM	700,00
	21027391AC	700,00
	21027391OR	849,00
	21027391OM	849,00

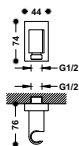

Shower holder
 with wall water outlet and check valve.

Supporto per doccia
 con presa d'acqua a parete e valvola antiritorno

Úchyt ruční sprchy se stěnovou přípojkou vody s nastavitelným výstupem pro vodu a zpětným ventilem.

	20718201	56,25
	20718201NM	92,85
	20718201BM	92,85
	20718201AC	92,85
	20718201OR	113,00
	20718201OM	113,00



Built-in mixer taps 3V

- Built-in body included (3 ways).
- Stainless steel wall shower with 2 jet types 280x550 mm.
- Elbow wall.
- Anti-limescale hand shower.
- Shower hose SATIN.

Monocomando incasso 3V

- Corpo incassato incluso (3 vie)
- Doccia acciaio inossidabile da parete con 2 tipi di getto 280x550 mm.
- Supporto per doccia.
- Doccetta anticalcare.
- Flessibile satin.

Vestavěná jednopáková baterie 3V

- Včetně podomítkového tělesa (3-cestná)
- Nástěnné sprchové křepítko z nerez. oceli s 2 typů proudění vody 280x550 mm.
- Držák s nástěnným přívodem vody.
- Ruční sprcha, proti usaz. vod. kamene.
- Flexi hadice SATIN.

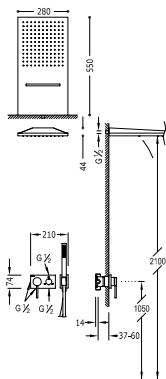

■ 21027301 1.082,00

■ M 21027301NM 1.785,00

■ M 21027301BM 1.785,00

■ 21027301AC 1.785,00

■ 24 21027301OR 2.163,00

■ 24 21027301OM 2.163,00



Built-in mixer taps 3V

- Built-in body included (3 ways).
- Stainless steel ceiling shower 500x500 mm. 2 positions.
- Elbow wall.
- Anti-limescale hand shower.
- Shower hose SATIN.

Monocomando incasso 3V

- Corpo incassato incluso (3 vie)
- Soffione doccia acciaio inossidabile 500x500 mm. 2 funzioni.
- Supporto per doccia.
- Doccetta anticalcare.
- Flessibile satin.

Vestavěná jednopáková baterie 3V

- Včetně podomítkového tělesa (3-cestná)
- Sprchové křepítko z nerez. oceli 500x500 mm. 2 funkce.
- Držák s nástěnným přívodem vody.
- Ruční sprcha, proti usaz. vod. kamene.
- Flexi hadice SATIN.

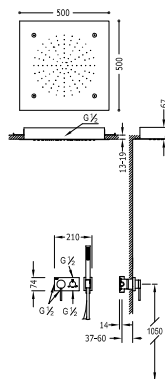

■ 21027302

1.345,00



3V





Built-in mixer taps 3V

- Built-in body included (3 ways).
- Stainless steel ceiling shower with cascade 500x650 mm.
- 2 positions.
- Elbow wall.
- Anti-limescale hand shower.
- Shower hose SATIN.

Monocomando incasso 3V

- Corpo incassato incluso (3 vie)
- Soffione doccia acciaio inossidabile con cascata 500x650 mm.
- 2 funzioni.
- Supporto per doccia.
- Doccetta anticalcare.
- Flessibile satin.

Vestavěná jednopáková baterie 3V

- Včetně podomítkového tělesa (3-cestná)
- Sprchové křepítka z nerez, oceli s kaskádou 500x650 mm. 2 funkce.
- Držák s nástěnným přívodem vody.
- Ruční sprcha, proti usaz. vod. kamene.
- Flexí hadice SATIN.

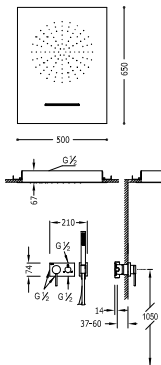

21027303 1.704,00

21027303NM 2.812,00

M 21027303BM 2.812,00

21027303AC 2.812,00

21027303OR 3.407,00

24 21027303OM 3.407,00



Built-in mixer taps 3V

- Built-in body included (3 ways).
- Fixed shower head Ø 300 mm. with ball joint. Brass.
- 3 Anti-limescale jets.
- Elbow wall.
- Anti-limescale hand shower.
- Shower hose SATIN.

Monocomando incasso 3V

- Corpo incassato incluso (3 vie)
- Doccia fissa Ø 300 mm. con snodo. Ottone.
- 3 jets anticalcare.
- Supporto per doccia.
- Doccetta anticalcare.
- Flessibile satin.

Vestavěná jednopáková baterie 3V

- Včetně podomítkového tělesa (3-cestná)
- Pevná sprcha Ø 300 mm. s kloubem. Materiál Mosaz.
- 3 natáčecí trysky, proti usaz. vod. Kamene.
- Držák s nástěnným přívodem vody.
- Ruční sprcha, proti usaz. vod. kamene.
- Flexí hadice SATIN.

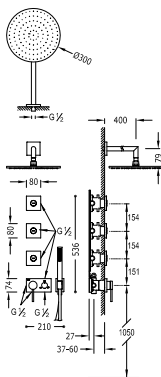

21027304

902,00





Built-in mixer taps 3V

- Built-in body included (3 ways).
- Stainless steel wall shower 160x550 mm.
- 3 Anti-limescale jets.
- Elbow wall.
- Anti-limescale hand shower.
- Shower hose SATIN.

Monocomando incasso 3V

- Corpo incassato incluso (3 vie)
- Doccia acciaio inossidabile da parete 160x550 mm.
- 3 jets anticalcare.
- Supporto per doccia.
- Doccetta anticalcare.
- Flessibile satin.

Vestavěná jednopáková baterie 3V

- Včetně podomítkového tělesa (3-cestná)
- Nástěnné sprchové křepitko z nerez. oceli 160x550 mm.
- 3 natáčecí trysky, proti usaz. vod. kamene.
- Držák s nástěnným přívodem vody.
- Ruční sprcha, proti usaz. vod. kamene.
- Flexi hadice SATIN.

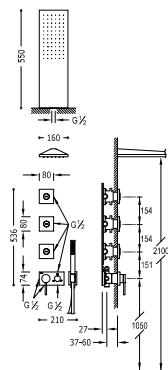

21027305

1.019,00

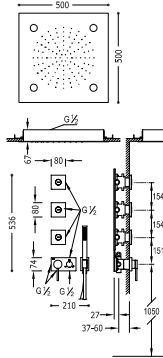

Built-in mixer taps 3V CHROMOTHERAPY

- Built-in body included (3 ways).
- Stainless steel ceiling shower 500x500 mm. 2 positions.
- 3 Anti-limescale jets.
- Elbow wall.
- Anti-limescale hand shower.
- Shower hose SATIN.

Monocomando incasso 3V CHROMOTHERAPY

- Corpo incassato incluso (3 vie)
- Soffione doccia acciaio inossidabile 500x500 mm. 2 funzioni.
- 3 jets anticalcare.
- Supporto per doccia.
- Doccetta anticalcare.
- Flessibile satin.

Vestavěná jednopáková baterie 3V CHROMOTHERAPY

- Včetně podomítkového tělesa (3-cestná)
- Sprchové kroupitko z nerez. oceli 500x500 mm. 2 funkce.
- 3 natáčecí trysky, proti usaz. vod. Kamene.
- Držák s nástěnným přívodem vody.
- Ruční sprcha, proti usaz. vod. kamene.
- Flexi hadice SATIN.



21027308

1.905,00

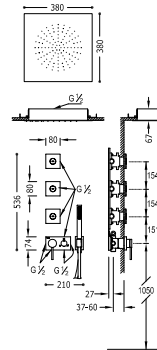

Built-in mixer taps 3V

- Built-in body included (3 ways).
- Stainless steel ceiling shower 380x380 mm.
- 3 Anti-limescale jets.
- Elbow wall.
- Anti-limescale hand shower.
- Shower hose SATIN.

Monocomando incasso 3V

- Corpo incassato incluso (3 vie)
- Soffione doccia acciaio inossidabile 380x380 mm.
- 3 jets anticalcare.
- Supporto per doccia.
- Doccetta anticalcare.
- Flessibile satin.

Vestavěná jednopáková baterie 3V

- Včetně podomítkového tělesa (3-cestná)
- Sprchové kroupitko z nerez. oceli 380x380 mm.
- 3 natáčecí trysky, proti usaz. vod. Kamene.
- Držák s nástěnným přívodem vody.
- Ruční sprcha, proti usaz. vod. kamene.
- Flexi hadice SATIN.



21027309

1.262,00



Built-in mixer taps 3V CHROMOTHERAPY

- Built-in body included (3 ways).
- Stainless steel ceiling shower 500x500 mm. 2 positions.
- Bath spout.
- Elbow wall.
- Anti-limescale hand shower.
- Shower hose SATIN.

Monocomando incasso 3V CHROMOTHERAPY

- Corpo incassato incluso (3 vie)
- Soffione doccia acciaio inossidabile 500x500 mm. 2 funzioni.
- Canna per vasca da bagno.
- Supporto per doccia.
- Doccetta anticalcare.
- Flessibile satin.

Vestavěná jednopáková baterie 3V CHROMOTHERAPY

- Včetně podomítkového tělesa (3-cestná)
- Sprchové křepítko z nerez. oceli 500x500 mm. 2 funkce.
- Kohoutek pro vanu.
- Držák s nástěnným přívodem vody.
- Ruční sprcha, proti usaz. kamene.
- Flexi hadice SATIN.

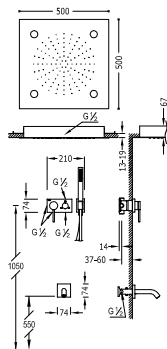

29919802

21027306

1.713,00



Built-in mixer taps 3V CHROMOTHERAPY

- Built-in body included (3 ways).
- Stainless steel ceiling shower 500x500 mm. 2 positions.
- Bath drain and round CASCADE filling valve with overflow drain.
- Bath PVC drain trap.
- Elbow wall.
- Anti-limescale hand shower.
- Shower hose SATIN.

Monocomando incasso 3V CHROMOTHERAPY

- Corpo incassato incluso (3 vie)
- Soffione doccia acciaio inossidabile 500x500 mm. 2 funzioni.
- Scarico vasca e valvola di riempimento rotonda A CASCATA con troppopieno.
- Sifone PVC vasca.
- Supporto per doccia.
- Doccetta anticalcare.
- Flessibile satin.

Vestavěná jednopáková baterie 3V CHROMOTHERAPY

- Včetně podomítkového tělesa (3-cestná)
- Sprchové křepítko z nerez. oceli 500x500 mm. 2 funkce.
- Odtoková a napouštěcí vanová kulata KASKÁDA s přepladem.
- Vanový sifon z PVC
- Držák s nástěnným přívodem vody.
- Ruční sprcha, proti usaz. vod. kamene.
- Flexi hadice SATIN.

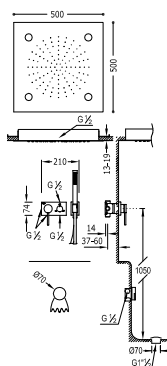

29919802

21027307

1.676,00

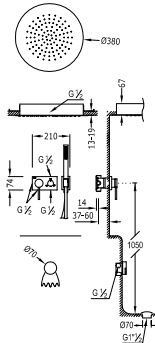

Built-in mixer taps 3V

- Built-in body included (3 ways).
- Stainless steel ceiling shower Ø 380 mm.
- Bath drain and round CASCADE filling valve with overflow drain.
- Bath PVC drain trap.
- Elbow wall.
- Anti-limescale hand shower.
- Shower hose SATIN.

Monocomando incasso 3V

- Corpo incassato incluso (3 vie)
- Soffione doccia acciaio inossidabile Ø 380 mm.
- Scarico vasca e valvola di riempimento rotonda A CASCATA con troppopieno.
- Sifone PVC vasca.
- Supporto per doccia.
- Doccetta anticalcare.
- Flessibile satin.

Vestavěná jednopáková baterie 3V

- Včetně podomítkového tělesa (3-cestná)
- Sprchové křepítko z nerez. oceli Ø 380 mm.
- Odtoková a napouštěcí vanová kulatá KASKÁDA s přepadem.
- Vanový sifon z PVC.
- Držák s nástěnným přívodem vody.
- Ruční sprcha, proti usaz. vod. kamene.
- Flexi hadice SATIN.



21027310

1.090,00

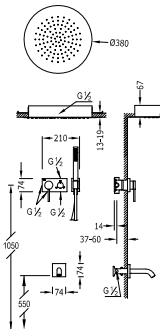

Built-in mixer taps 3V

- Built-in body included (3 ways).
- Stainless steel ceiling shower Ø 380 mm.
- Bath spout.
- Elbow wall.
- Anti-limescale hand shower.
- Shower hose SATIN.

Monocomando incasso 3V

- Corpo incassato incluso (3 vie)
- Soffione doccia acciaio inossidabile Ø 380 mm.
- Canna per vasca da bagno.
- Supporto per doccia.
- Doccetta anticalcare.
- Flessibile satin.

Vestavěná jednopáková baterie 3V

- Včetně podomítkového tělesa (3-cestná)
- Sprchové křepítko z nerez. oceli Ø 380 mm.
- Kohoutek pro vanu.
- Držák s nástěnným přívodem vody.
- Ruční sprcha, proti usaz. vod. kamene.
- Flexi hadice SATIN.

21027311

1.127,00

21027311NM

1.860,00

21027311BM

1.860,00

21027311AC

1.860,00





Built-in mixer taps 3V

- Built-in body included (3 ways).
- Stainless steel wall shower 160x550 mm.
- Bath drain and round CASCADE filling valve with overflow drain.
- Bath PVC drain trap.
- Elbow wall.
- Anti-limescale hand shower.
- Shower hose SATIN.

Monocomando incasso 3V

- Corpo incassato incluso (3 vie)
- Doccia acciaio inossidabile da parete 160x550 mm.
- Scarico vasca e valvola di riempimento rotonda A CASCATA con troppopieno.
- Sifone PVC vasca.
- Supporto per doccia.
- Doccetta anticalcare.
- Flessibile satin.

Vestavěná jednopáková baterie 3V

- Včetně podomítkového tělesa (3-cestná)
- Nástěnné sprchové křepítko z nerez. oceli 160x550 mm.
- Odkovová a napouštěcí vanová kulatá KASKÁDA s případem.
- Vanový sifon z PVC.
- Držák s nástěnným přívodem vody.
- Ruční sprcha, proti usaz. vod. kamene.
- Flexi hadice SATIN.

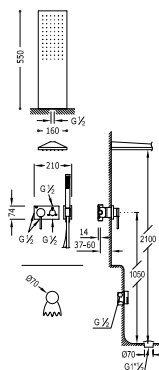

21027312

790,00

Built-in mixer taps 3V

- Built-in body included (3 ways).
- Fixed shower head Ø 300 mm. with ball joint. Brass.
- Bath spout.
- Elbow wall.
- Anti-limescale hand shower.
- Shower hose SATIN.

Monocomando incasso 3V

- Corpo incassato incluso (3 vie)
- Doccia fissa Ø 300 mm. con snodo. Ottone.
- Canna per vasca da bagno.
- Supporto per doccia.
- Doccetta anticalcare.
- Flessibile satin.

Vestavěná jednopáková baterie 3V

- Včetně podomítkového tělesa (3-cestná)
- Pevná sprcha Ø 300 mm. s kloubem. Materiál Mosaz.
- Kohoutek pro vanu.
- Držák s nástěnným přívodem vody.
- Ruční sprcha, proti usaz. vod. kamene.
- Flexi hadice SATIN.

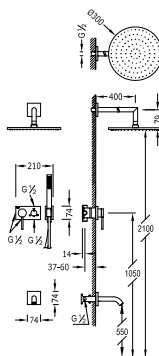

21027313

713,00

M 21027313NM

1.176,00

M 21027313BM

1.176,00

M 21027313AC

1.176,00



306 / **Showers head** | *Docce da soffitto* / *Stropní sprchy*320 / **Wall showers** | *Docce a parete* / *Nástěnné sprchy*322 / **Showers head** | *Docce da soffitto* / *Stropní sprchy*324 / **Sliding bar** | *Asta antiscivolo* / *Posuvná tyč*326 / **Showers** | *Doccia* / *Sprchy*329 / **Jets** | *Bocchette* / *Stimulační trysky* *Jets*331 / **Supports** | *Supporti* / *Podstavce*

SHOWER PROGRAMME PROGRAMMA PER DOCCE SPRCHOVÝ PROGRAM



www.qtr.es/shower-complements



Chrome
Cromato
Chrom



Matt Black
Nero Opaco
Cerná mat



Matt White
Bianco Opaco
Bílá mat



Steel
Acciaio
Ocel



Metallic black
Nero metallizzato
Metalická černá barva



Brushed metallic black
Nero metallizzato spazzolato
Metalická černá barva kartáčovaná



Gold 24K
Oro 24K
Zlato 24K



Matt gold 24K
Oro 24K Opaco
Zlato 24K mat



Rose gold 24K
Oro rosa 24K
Růžové zlato 24K



Aged brass
Ottone invecchiato
Zestárilá mosaz



Matt Aged brass
Ottone invecchiato Opaco
Zestárilá mosaz mat



Amber-Chrome
Ambra-Cromato
Jantarová-Chrom



Orange-Chrome
Arancione-Cromato
Oranžová-Chrom



Red-Chrome
Rosso-Cromato
Červená-Chrom



Purple-Chrome
Viola-Cromato
Fialová-Chrom



Fuchsia-Chrome
Fucsia-Cromato
Fuchsiová-Chrom



Green-Chrome
Verde-Cromato
Zelená-Chrom



Black-Chrome
Nero-Cromato
Černá-Chrom



White-Chrome
Bianco-Cromato
Bílá-Chrom

Steel shower head antilime

2 jet types (Rain/Cascade). 500x800 mm. Water supply through 3 independent outlet.

Soffione doccia acciaio inossidabile anticalcare

2 tipi di getto (Pioggia/Cascata). 500x800 mm. Alimentazione attraverso 3 vie d'acqua independent.

Stropní sprchové křepitko z nerez. oceli, proti usaz. vod. kamene

2 typů proudění vody (Děšť/Kahádou). 500x800 mm. Nezávislé třicestné napájení vodo.

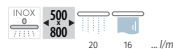
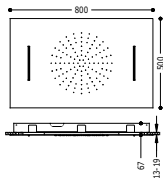

	29996601	1.606,00
	M 29996601NM	2.650,00
	M 29996601BM	2.650,00
	M 29996601AC	2.650,00

Steel shower head CHROMOTHERAPY

2 jet types (Rain/Cascade). 500x800 mm. Water supply through 3 independent outlet. Once connected to the mains, the light can be turned on and off manually, using the switch.

Soffione doccia acciaio inossidabile CHROMOTHERAPY

2 tipi di getto (Pioggia/Cascata). 500x800 mm. Alimentazione attraverso 3 vie d'acqua independent. La luce, una volta collegata alla corrente, si attiva manualmente con un interruttore.

Stropní sprchové křepitko z nerez. oceli, CHROMOTHERAPIE

2 typů proudění vody (Děšť/Kahádou), proti usaz. vod. kamene. 500x800 mm. Nezávislé třicestné napájení vodo. Elektrická energie a její připojení se ovládá manuálně, prostřednictvím vypínače.

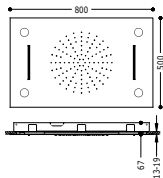

	29996501	2.131,00
--	----------	-----------------

Steel shower head antilime

2 jet types (Rain/Cascade). 500x650 mm. Water supply through 2 independent outlet.

Soffione doccia acciaio inossidabile anticalcare

2 tipi di getto (Pioggia/Cascata). 500x650 mm. Alimentazione attraverso 2 vie d'acqua independent.

Stropní sprchové křepitko z nerez. oceli, proti usaz. vod. kamene

2 typů proudění vody (Děšť/Kahádou). 500x650 mm. Nezávislé dvudrožna napájení vodo.

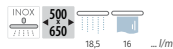
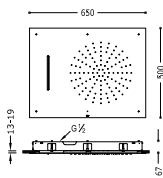

	29997001	1.470,00
	M 29997001NM	2.426,00
	M 29997001BM	2.426,00
	M 29997001AC	2.426,00

Steel shower head CHROMOTHERAPY

2 jet types (Rain/Cascade). 500x650 mm. Water supply through 2 independent outlet. Once connected to the mains, the light can be turned on and off manually, using the switch.

Soffione doccia acciaio inossidabile CHROMOTHERAPY

2 tipi di getto (Pioggia/Cascata). 500x650 mm. Alimentazione attraverso 2 vie d'acqua independent. La luce, una volta collegata alla corrente, si attiva manualmente con un interruttore.

Stropní sprchové křepitko z nerez. oceli, CHROMOTHERAPIE

2 typů proudění vody (Děšť/Kahádou), proti usaz. vod. kamene. 500x650 mm. Nezávislé dvudrožna napájení vodo. Elektrická energie a její připojení se ovládá manuálně, prostřednictvím vypínače.

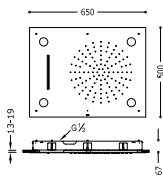

	29997201	1.994,00
--	----------	-----------------

Steel shower head antilime

3 jet types (Rain/Cascade/Micro drop). 500x650 mm. Water supply through 3 independent outlet.

Soffione doccia acciaio inossidabile anticalcare
3 tipi di getto (Pioggia/Cascata/Micro drop). 500x650 mm.
Alimentazione attraverso 3 vie d'acqua independent.

Stropní sprchové křopitko z nerez. oceli, proti usaz. vod. kamene

3 typů proudění vody (Děšť/Kaládou/Micro drop), proti usaz. vod. kamene. 500x650 mm. Nezávislé třicestné napájení vodu.

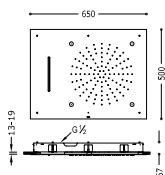

29997101

1.591,00

Steel shower head CHROMOTHERAPY

Chromotherapy. 500x500 mm. Once connected to the mains, the light turns on when water passes, without the need for a switch.

Soffione doccia acciaio inossidabile CHROMOTHERAPY
Chromotherapy. 500x500 mm. La luce, una volta collegata alla corrente, si accende al passaggio dell'acqua senza che occorra un interruttore.

Stropní sprchové křopitko z nerez. oceli, systém proti usaz. vod. kamene CHROMOTHERAPIE

500x500 mm. Světlo se po připojení elektriny rozsvítí díky proudu vody, bez vypínače.

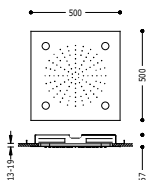

29996201

1.378,00

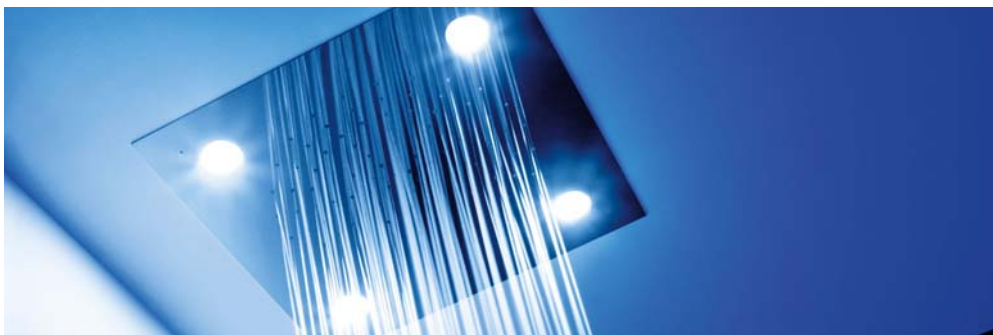

Steel shower head antilime

2 jet types (Rain/Micro drop). 500x500 mm. Water supply through 2 independent outlets.

Soffione doccia acciaio inossidabile anticalcare
2 tipi di getto (Pioggia/Micro drop). 500x500 mm. Alimentazione attraverso 2 vie d'acqua indipendenti.

Stropní sprchové křopitko z nerez. oceli, proti usaz. vod. kamene

2 typů proudění vody (Děšť/Micro drop). 500x500 mm. Nezávislé 2-cestné napájení vodu.

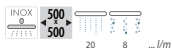
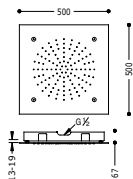

29995401



1.070,00

Steel shower head antilime
500x500 mm.

Soffione doccia acciaio inossidabile anticalcare
500x500 mm.

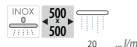
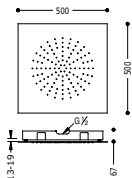
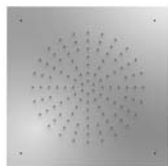
Stropní sprchové křepítko z nerez. oceli, proti usaz. vod. kamene
systém proti usaz. vod. kamene 500x500 mm.



	29995302	889,00
	29995302NM	1.467,00
	29995302BM	1.467,00
	29995302AC	1.467,00
	29995302OR	1.778,00
	29995302OM	1.778,00

Steel shower head antilime
380x380 mm.

Soffione doccia acciaio inossidabile anticalcare
380x380 mm.

Stropní sprchové křepítko z nerez. oceli, proti usaz. vod. kamene
systém proti usaz. vod. kamene 380x380 mm.

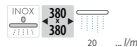
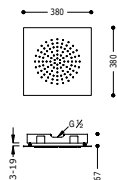
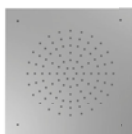



	29995301	664,00
	29995301NM	1.097,00
	29995301BM	1.097,00
	29995301AC	1.097,00
	29995301OR	1.329,00
	29995301OM	1.329,00

Steel shower head antilime
2 jet types (Rain/Cascade).

Soffione doccia acciaio inossidabile anticalcare
Anticalcare. 2 tipi di getto (Pioggia/Cascata).

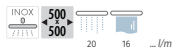
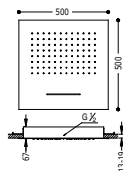
Stropní sprchové křepítko z nerez. oceli, proti usaz. vod. kamene
2 typů proudění vody (Děšť/Kakádou), proti usaz. vod. kamene.





	29995501	957,00
	29995501AC	1.579,00
	29995501NM	1.579,00
	29995501BM	1.579,00

Steel shower head antilime
500x500 mm.

Soffione doccia acciaio inossidabile anticalcare
500x500 mm.

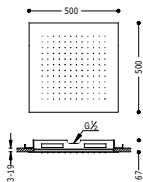
Stropní sprchové křepítko z nerez. oceli, proti usaz. vod. kamene
systém proti usaz. vod. kamene 500x500 mm.



	134951	889,00
	134951NM	1.467,00
	134951BM	1.467,00
	134951AC	1.467,00
	134951OR	1.778,00
	134951OM	1.778,00

Steel shower head antilime

380x380 mm.

Soffione doccia acciaio inossidabile anticalcare
380x380 mm.

Stropní sprchové kropitko z nerez. oceli, proti usaz. vod. kamene

systém proti usaz. vod. kamene 380x380 mm.

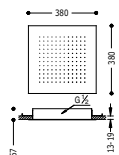

	134944	664,00
	M 134944NM	1.097,00
	M 134944BM	1.097,00
	134944AC	1.097,00
	24 134944OR	1.329,00
	24 134944OM	1.329,00

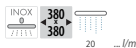

Steel shower head antilime

420x420 mm.

Soffione doccia acciaio inossidabile anticalcare
420x420 mm.

Stropní sprchové kropitko z nerez. oceli, proti usaz. vod. kamene

systém proti usaz. vod. kamene 420x420 mm.

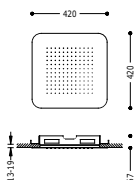

	29951607	777,00
	M 29951607NM	1.282,00
	M 29951607BM	1.282,00
	29951607AC	1.282,00
	24 29951607OR	1.553,00
	24 29951607OM	1.553,00



Steel shower head antilime

2 jet types (Rain/Micro drop), Ø 600 mm. Water supply through 2 independent outlets.

Soffione doccia acciaio inossidabile anticalcare
2 tipi di getto (Pioggia/Micro drop), Ø 600 mm. Alimentazione attraverso 2 vie d'acqua indipendenti.

Stropní sprchové kropitko z nerez. oceli, proti usaz. vod. kamene

2 typů proudění vody (Děšť/Micro drop), Ø 600 mm. Nezávislé 2-cestné napájení vodou.

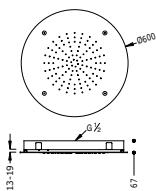

	29995601	1.258,00
--	----------	----------



Steel shower head CHROMOTHERAPY

Ø 600 mm. Water supply through 1 independent outlet. Once connected to the mains, the light turns on when water passes, without the need for a switch.

Soffione doccia acciaio inossidabile CHROMOTHERAPY
Ø 600 mm. Alimentazione attraverso 1 via d'acqua indipendente. La luce, una volta collegata alla corrente, si accende al passaggio dell'acqua senza che occorra un interruttore.

Stropní sprchové kropitko z nerez. oceli, CHROMOTHERAPIE
Systém proti usaz. vod. kamene, Ø 600 mm. Nezávislé jednocestné napájení vodou. Po připojení elektriny se světlo rozsvítí bez vypínače spuštěním proudu vody.

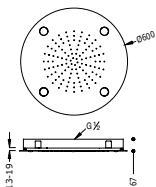

	29995701	1.661,00
--	----------	----------





Steel shower head CHROMOTHERAPY

2 jet types (Rain/Micro drop), Ø 600 mm. Water supply through 2 independent outlets. Once connected to the mains, the light can be turned on and off manually, using the switch.

Soffione doccia acciaio inossidabile CHROMOTHERAPY 2 tipi di getto (Pioggia/Micro drop), Ø 600 mm. Alimentazione attraverso 2 vie d'acqua indipendenti. La luce, una volta collegata alla corrente, si attiva manualmente con un interruttore.

Stropní sprchové křepítko ocel, systém proti usaz. vod. kamene CHROMOTHERAPY

2 typů proudění vody (Děšť/Micro drop), proti usaz. vod. kamene. Ø 600 mm. Nezávislé 2-cestné napájení vodou. Elektrická energie a její připojení se ovládá manuálně, prostřednictvím vypínače.

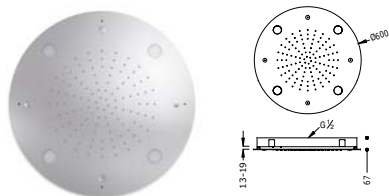

29995801

2.022,00

Steel shower head antilime

Ø 500 mm.

Soffione doccia acciaio inossidabile anticalcare Ø 500 mm.

Stropní sprchové křepítko systém proti usaz. vod. kamene Ø 500 mm.

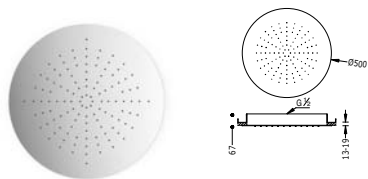

134950

889,00

M 134950NM

1.467,00

M 134950BM

1.467,00

134950AC

1.467,00

24 134950OR

1.778,00

24 134950OM

1.778,00

Steel shower head antilime

Ø 380 mm.

Soffione doccia acciaio inossidabile anticalcare Ø 380 mm.

Stropní sprchové křepítko systém proti usaz. vod. kamene Ø 380 mm.

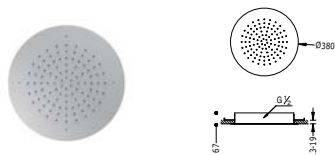

134940

727,00

M 134940NM

1.200,00

M 134940BM

1.200,00

134940AC

1.200,00

24 134940OR

1.454,00

24 134940OM

1.454,00



Steel Wall showers antilime
2 jet types (Rain/Cascade). 280x550 mm.

Docce acciaio inossidabile da parete
Anticalcare. 2 tipi di getto (Pioggi/Cascata). 280x550 mm.

Nástěnné sprchové křopítko
2 typů proudění vody (Děšť/Kakádou), proti usaz. vod. kamene.
280x550 mm.

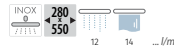
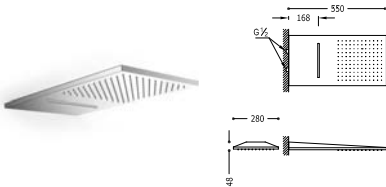

29990301 777,00

M 29990301NM 1.282,00

M 29990301BM 1.282,00

29990301AC 1.282,00

Steel Wall showers antilime
210x550 mm.

Docce acciaio inossidabile da parete
Anticalcare. 210x550 mm.

Nástěnné sprchové křopítko
se systémem proti usaz. vod. kamene 210x550 mm.

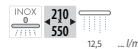
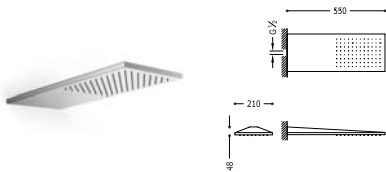

29990302 426,00

M 29990302NM 705,00

M 29990302BM 705,00

29990302AC 705,00

Z 29990302OR 853,00

Z 29990302OM 853,00

Steel Wall showers antilime
160x550 mm.

Docce acciaio inossidabile da parete
Anticalcare. 160x550 mm.

Nástěnné sprchové křopítko
se systémem proti usaz. vod. kamene 160x550 mm.

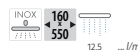
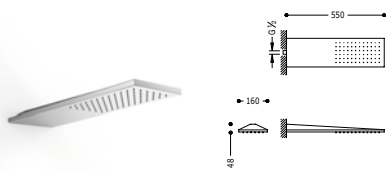

29990303 383,00

M 29990303NM 632,00

M 29990303BM 632,00

29990303AC 632,00

Z 29990303OR 766,00

Z 29990303OM 766,00

Steel Wall showers antilime
2 jet types (Rain/Cascade). 280x550 mm.

Docce acciaio inossidabile da parete
 Anticalcare. 2 tipi di getto (Pioggia/Cascata). 280x550 mm.

Nástěnné sprchové křepítko
 2 typů proudění vody (Děšť/Kakádou), proti usaz. vod. kamene.
 280x550 mm.

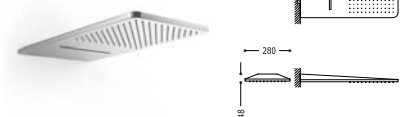

- 29990308 **845,00**
- 29990308NM **1.394,00**
- M 29990308BM **1.394,00**
- 29990308AC **1.394,00**



Steel Wall showers antilime
210x550 mm.

Docce acciaio inossidabile da parete
 Anticalcare. 210x550 mm.

Nástěnné sprchové křepítko
 se systémem proti usaz. vod. kamene 210x550 mm.

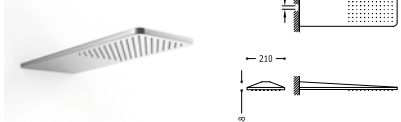

- 29990307 **514,00**
- M 29990307NM **849,00**
- 29990307BM **849,00**
- 29990307AC **849,00**
- 24 29990307OR **1.028,00**
- 24 29990307OM **1.028,00**



Steel Wall showers antilime
160x550 mm.

Docce acciaio inossidabile da parete
 Anticalcare. 160x550 mm.

Nástěnné sprchové křepítko
 se systémem proti usaz. vod. kamene 160x550 mm.

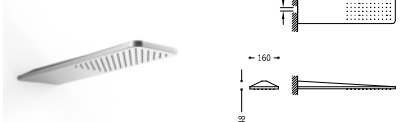

- 29990306 **470,00**
- M 29990306NM **776,00**
- 29990306BM **776,00**
- 29990306AC **776,00**
- 24 29990306OR **939,00**
- 24 29990306OM **939,00**



Ceiling shower antilime
Ø 330 mm.

Soffione doccia anticalcare
 Ø 330 mm.

Stropní sprchové křepítko
 systém proti usaz. vod. kamene. Ø 330 mm.



- 134715 **426,00**



Steel Wall shower antilime
2 jet types (Rain/Cascade).

Doccia acciaio inossidabile
Anticalcare. 2 tipi di getto (Pioggia/Cascata).

Nástěnné sprchové křovítko
2 typů proudění vody (Děšť/Kaškádou), proti usaz. vod. kamene.

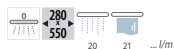
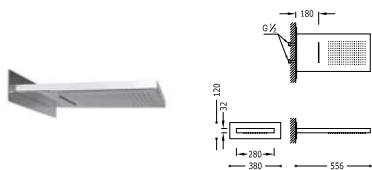

134903

861,00

Ceiling shower antilime
330x330 mm.

Soffione doccia anticalcare
330x330 mm.

Stropní sprchové křovítko
systém proti usaz. vod. kamene. 330x330 mm.

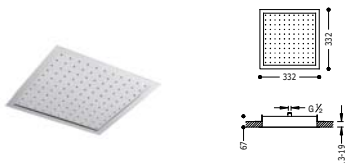

134714

426,00



Steel Wall shower
with cascade. 152x200 mm.

Docce acciaio inossidabile da parete
con cascata. 152x200 mm.

Nástěnné sprchové křovítko
s kaškádou 152x200 mm.

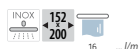
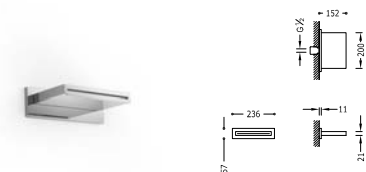

29990304

367,00

M 29990304NM 606,00

M 29990304BM 606,00

29990304AC 606,00

24 29990304OR 733,00

24 29990304OM 733,00

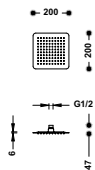

Steel shower head antilime with ball joint. 200x200 mm.

Soffione doccia acciaio inossidabile anticalcare con snodo. 200x200 mm.

Stropní sprchové křepítko z nerez. oceli, proti usaz. vod. kamene s kloubem. 200x200 mm.

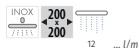

134315002

56,65

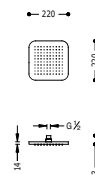

Antilime shower head with ball joint. Full chromed showerhead 220x220 mm.

Soffione doccia anticalcare con snodo. Soffione interamente cromato 220x220 mm.

Sprchové křepítko se systémem proti usaz. vod. kamene s kloubem. Celochromové 220x220 mm.



29963206

103,00

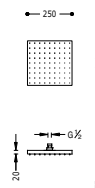

Antilime shower head with ball joint. Full chromed showerhead 250x250 mm.

Soffione doccia anticalcare con snodo. Soffione interamente cromato 250x250 mm.

Sprchové křepítko se systémem proti usaz. vod. kamene s kloubem. Celochromové 250x250 mm.

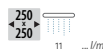

13413826

126,00

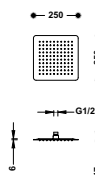

Steel shower head antilime with ball joint. 250x250 mm.

Soffione doccia acciaio inossidabile anticalcare con snodo. 250x250 mm.

Stropní sprchové křepítko z nerez. oceli, proti usaz. vod. kamene s kloubem. 250x250 mm.

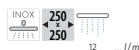

134315004

97,85

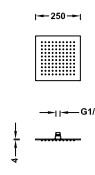

Steel shower head antilime with ball joint. 250x250 mm.

Soffione doccia acciaio inossidabile anticalcare con snodo. 250x250 mm.

Stropní sprchové křepítko z nerez. oceli, proti usaz. vod. kamene s kloubem. 250x250 mm.



134315011

112,00

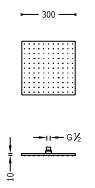

Antilime shower head with ball joint. Brass 300x300 mm.

Soffione doccia anticalcare con snodo. Ottone 300x300 mm.

Sprchové křepítko se systémem proti usaz. vod. kamene s kloubem. Materiál Mosaz 300x300 mm



13413830

227,00

13413830NM

374,00

13413830BM

374,00

13413830AC

374,00

13413830OR

453,00

13413830OM

453,00

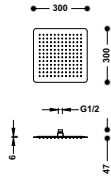

Steel shower head antilime with ball joint. 300x300 mm.

Soffione doccia acciaio inossidabile anticalcare con snodo. 300x300 mm.

Stropní sprchové křepítko z nerez. oceli, proti usaz. vod. kamene s kloubem. 300x300 mm.

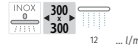

134315006

113,00

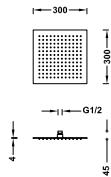
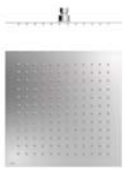

Steel shower head antilime with ball joint. 300x300 mm.

Soffione doccia acciaio inossidabile anticalcare con snodo. 300x300 mm.

Stropní sprchové křepítko z nerez. oceli, proti usaz. vod. kamene s kloubem. 300x300 mm.



134315012

131,00

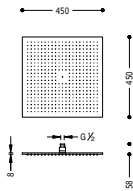

Antilime shower head with ball joint. 450x450 mm.

Soffione doccia anticalcare con snodo. 450x450 mm.

Sprchové křepítko se systémem proti usaz. vod. kamene s kloubem. 450x450 mm.

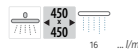

29963205

368,00

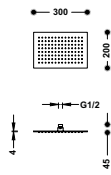
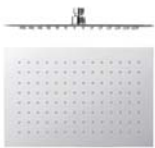

Steel shower head antilime with ball joint. 300x200 mm.

Soffione doccia acciaio inossidabile anticalcare con snodo. 300x200 mm.

Stropní sprchové křepítko z nerez. oceli, proti usaz. vod. kamene s kloubem. 300x200 mm.

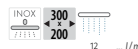

134315007

165,00

- 134315007NM 280,00
- 134315007BM 280,00
- 134315007AC 280,00
- 134315007OR 340,00
- 134315007OM 340,00

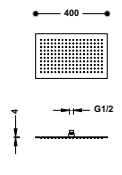
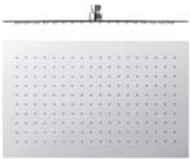

Steel shower head antilime with ball joint. 400x250 mm.

Soffione doccia acciaio inossidabile anticalcare con snodo. 400x250 mm.

Stropní sprchové křepítko z nerez. oceli, proti usaz. vod. kamene s kloubem. 400x250 mm.



134315008

258,00

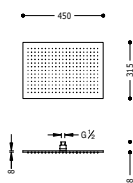
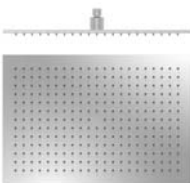

Antilime shower head with ball joint. 450x315 mm.

Soffione doccia anticalcare con snodo. 450x315 mm.

Sprchové křepítko se systémem proti usaz. vod. kamene s kloubem. 450x315 mm.



29963203

350,00

- 29963203NM 578,00
- 29963203BM 578,00
- 29963203AC 578,00
- 29963203OR 700,00
- 29963203OM 700,00

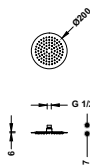

Steel shower head antilime with ball joint. Ø 200 mm.

Soffione doccia acciaio inossidabile anticalcare con snodo. Ø 200 mm.

Stropní sprchové křepítko z nerez. oceli, proti usaz. vod. kamene s kloubem. Ø 200 mm.



134315001

42,75

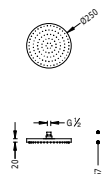

Antilime shower head with ball joint. Full chromed showerhead Ø 250 mm.

Soffione doccia anticalcare con snodo. Soffione interamente cromato Ø 250 mm.

Sprchové křepítko se systémem proti usaz. vod. kamene s kloubem. Celochromové Ø 250 mm

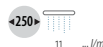

13413726

104,00

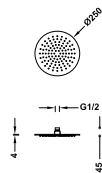

Steel shower head antilime with ball joint. Ø250 mm.

Soffione doccia acciaio inossidabile anticalcare con snodo. Ø250 mm.

Stropní sprchové křepítko z nerez. oceli, proti usaz. vod. kamene s kloubem. Ø250 mm.



134315009

93,60

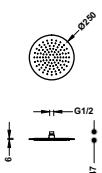

Steel shower head antilime with ball joint. Ø 250 mm.

Soffione doccia acciaio inossidabile anticalcare con snodo. Ø 250 mm.

Stropní sprchové křepítko z nerez. oceli, proti usaz. vod. kamene s kloubem. Ø 250 mm.



134315003

81,40

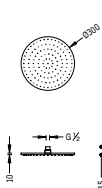

Antilime shower head with ball joint. Brass Ø 300 mm.

Soffione doccia anticalcare con snodo. Ottone Ø 300 mm.

Sprchové křepítko se systémem proti usaz. vod. kamene s kloubem. Materiál Mosaz Ø 300 mm



13413730

198,00

- 13413730NM 327,00
- 13413730BM 327,00
- 13413730AC 327,00
- 13413730KM 327,00
- 13413730OR 396,00
- 13413730OM 396,00

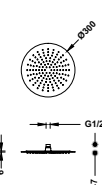

Steel shower head antilime with ball joint. Ø 300 mm.

Soffione doccia acciaio inossidabile anticalcare con snodo. Ø 300 mm.

Stropní sprchové křepítko z nerez. oceli, proti usaz. vod. kamene s kloubem. Ø 300 mm.



134315005

103,00

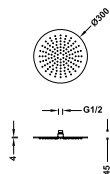
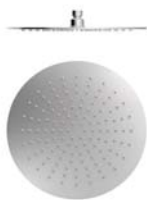

Steel shower head antilime with ball joint. Ø 300 mm.

Soffione doccia acciaio inossidabile anticalcare con snodo. Ø 300 mm.

Stropní sprchové křepítka z nerez. oceli, proti usaz. vod. kamene s kloubem. Ø 300 mm.



134315010 118,00

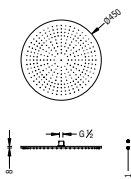
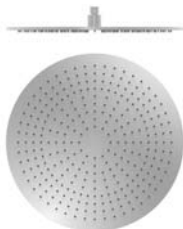

Antilime shower head with ball joint. Ø 450 mm.

Soffione doccia acciaio anticalcare con snodo. Ø 450 mm.

Hubice se systémem proti vzniku vodního kamene s kloubem. Ø 450 mm.



29963204 338,00

M 29963204NM 558,00

M 29963204BM 558,00

29963204AC 558,00

Z 29963204OR 676,00

Z 29963204OM 676,00

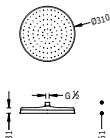

Antilime shower head with ball joint. Ø 310 mm.

Soffione doccia acciaio anticalcare con snodo. Ø 310 mm.

Sprchové křepítka se systémem proti usaz. vod. kamene s kloubem. Ø 310 mm.



29933703 217,00

29933703AC 360,00

Z 29933703OR 435,00

29933703LV 305,00

M 29933703LM 305,00



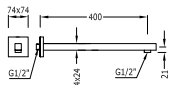

Shower bar holder for shower spout

Braccio doccia per soffione doccia

Nástěnné rameno na sprchové křepítko

	13413940	72,20
	13413940NM	120,00
	13413940BM	120,00
	13413940AC	120,00
	13413940OR	145,00
	13413940OM	145,00

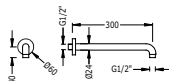

Shower bar holder for shower spout

Braccio doccia per soffione doccia

Nástěnné rameno na sprchové křepítko

	13462101	50,35
--	----------	--------------

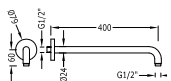

Shower bar holder for shower spout

Braccio doccia per soffione doccia

Nástěnné rameno na sprchové křepítko

	13462104	61,25
	13462104NM	101,00
	13462104BM	101,00
	13462104AC	101,00
	13462104KM	101,00
	13462104KMB	101,00
	13462104OR	123,00
	13462104OM	123,00
	13462104OP	123,00

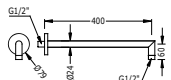

Shower bar holder for shower spout

Braccio doccia per soffione doccia

Nástěnné rameno na sprchové křepítko

	16118740	61,25
	16118740NM	101,00
	16118740BM	101,00
	16118740AC	101,00
	16118740OR	123,00
	16118740OM	123,00

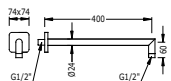

Shower bar holder for shower spout

Braccio doccia per soffione doccia

Nástěnné rameno na sprchové křepítko

	29963902	65,65
	29963902NM	109,00
	29963902BM	109,00
	29963902AC	109,00
	29963902OR	132,00
	29963902OM	132,00

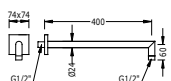

Shower bar holder for shower spout

Braccio doccia per soffione doccia

Nástěnné rameno na sprchové křepítko

	06243201	65,65
	06243201NM	109,00
	06243201BM	109,00
	06243201AC	109,00
	06243201KM	109,00
	06243201OR	132,00
	06243201OM	132,00

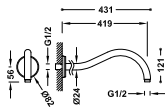

**Shower bar holder
for shower spout**

Braccio doccia
per soffione doccia

Nástěnné rameno
na sprchové kropítko

■ 29933701	72,10
■ 29933701AC	120,00
■ 29933701OR	144,00
■ 29933701LV	101,00
■ 29933701LM	101,00

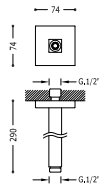

**Ceiling arm
for shower spout**

Braccio tetto
per soffione doccia

Stropní rameno
na sprchové kropítko

■ 13462202	61,80
■ 13462202NM	102,00
■ 13462202BM	102,00
■ 13462202AC	102,00
■ 13462202OR	124,00
■ 13462202OM	124,00

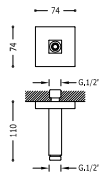

**Ceiling arm
for shower spout**

Braccio tetto
per soffione doccia

Stropní rameno
na sprchové kropítko

■ 13452202	51,50
■ 13452202NM	85,00
■ 13452202BM	85,00
■ 13452202AC	85,00
■ 13452202OR	103,00
■ 13452202OM	103,00

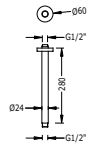

**Ceiling arm
for shower spout**

Braccio tetto
per soffione doccia

Stropní rameno
na sprchové kropítko

■ 13462102	48,20
■ 13462102NM	79,50
■ 13462102BM	79,50
■ 13462102AC	79,50
■ 13462102OR	96,35
■ 13462102OM	96,35

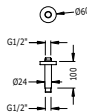

**Ceiling arm
for shower spout**

Braccio tetto
per soffione doccia

Stropní rameno
na sprchové kropítko

■ 13452102	40,50
■ 13452102NM	66,80
■ 13452102BM	66,80
■ 13452102AC	66,80
■ 13452102KM	66,80
■ 13452102OR	81,00
■ 13452102OM	81,00

WALL SHOWERS | DOCCE A PARETE | NÁSTĚNNÉ SPRCHY

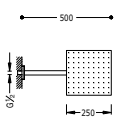
Wall shower arm with antilime shower head with ball joint. 250x250 mm.

Braccio doccia a parete con soffione anticalcare con snodo. 250x250 mm.

Nástěnné sprchové ramínko s křepítkem se systémem proti usaz. vod. kamene s kloubem. 250x250 mm.



134233 **198,00**





Wall shower arm with antilime shower head with ball joint. 300x300 mm.

Braccio doccia a parete con soffione anticalcare con snodo. 300x300 mm.

Nástěnné sprchové ramínko s křepítkem se systémem proti usaz. vod. kamene s kloubem. 300x300 mm.



134433 **300,00**





Wall shower arm with antilime shower head with ball joint. 300x200 mm.

Braccio doccia a parete con soffione anticalcare con snodo. 300x200 mm.

Nástěnné sprchové ramínko s křepítkem proti usaz. vod. kamene s kloubem. 300x200 mm.

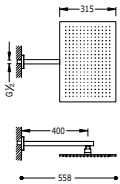

29953202 **302,00**

Wall shower arm with antilime shower head with ball joint. 450x315 mm.

Braccio doccia a parete con soffione anticalcare con snodo. 450x315 mm.

Nástěnné sprchové ramínko s křepítkem proti usaz. vod. kamene s kloubem. 450x315 mm.

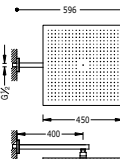

29953203 **422,00**

Wall shower arm with antilime shower head with ball joint. 450x450 mm.

Braccio doccia a parete con soffione anticalcare con snodo. 450x450 mm.

Nástěnné sprchové ramínko s křepítkem proti usaz. vod. kamene s kloubem. 450x450 mm.

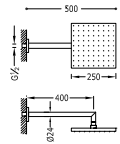

29953205 **440,00**

Wall shower arm with antilime shower head with ball joint. 250x250 mm.

Braccio doccia a parete con soffione anticalcare con snodo. 250x250 mm.

Nástěnné sprchové ramínko s křepítkem se systémem proti usaz. vod. kamene s kloubem. 250x250 mm.



03423101 **191,00**

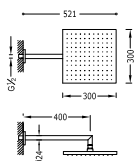

Wall shower arm with antilime shower head with ball joint. 300x300 mm.

Braccio doccia a parete con soffione anticalcare con snodo. 300x300 mm.

Nástěnné sprchové ramínko s kropítkem se systémem proti usaz. vod. kamene s kloubem. 300x300 mm.

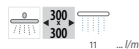

03443101

292,00

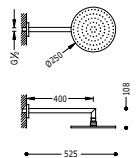

Wall shower arm with antilime shower head with ball joint. Ø 250 mm.

Braccio doccia a parete con soffione anticalcare con snodo. Ø 250 mm.

Nástěnné sprchové ramínko s kropítkem se systémem proti usaz. vod. kamene s kloubem. Ø 250 mm.



134232

166,00

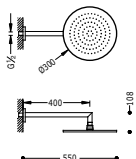

Wall shower arm with antilime shower head with ball joint. Ø 300 mm.

Braccio doccia a parete con soffione anticalcare con snodo. Ø 300 mm.

Nástěnné sprchové ramínko s kropítkem se systémem proti usaz. vod. kamene s kloubem. Ø 300 mm.



134432

259,00

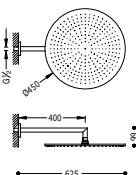

Wall shower arm with antilime shower head with ball joint. Ø 450 mm.

Braccio doccia a parete con soffione anticalcare con snodo. Ø 450 mm.

Nástěnné sprchové ramínko s kropítkem se systémem proti usaz. vod. kamene s kloubem. Ø 450 mm.



29953204

399,00

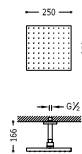

Ceiling shower arm with antilime shower head with ball joint. 250x250 mm.

Braccio doccia a soffitto con soffione anticalcare con snodo. 250x250 mm.

Stropní sprchové ramínko s kropítkem se systémem proti usaz. vod. kamene s kloubem. 250x250 mm.

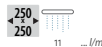

03412102

177,00

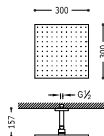

Ceiling shower arm with antilime shower head with ball joint. 300x300 mm.

Braccio doccia a soffitto con soffione anticalcare con snodo. 300x300 mm.

Stropní sprchové ramínko s kropítkem se systémem proti usaz. vod. kamene s kloubem. 300x300 mm.



03483102

278,00

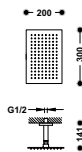

Ceiling shower arm with antilime shower head with ball joint. 300x200 mm.

Braccio doccia a soffitto con soffione anticalcare con snodo. 300x200 mm.

Stropní sprchové ramínko s kropítkem se systémem proti usaz. vod. kamene s kloubem. 300x200 mm.

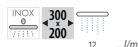

03443202

281,00

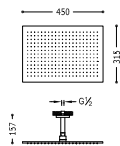

Ceiling shower arm with antilime shower head with ball joint. 450x315 mm.

Braccio doccia a soffitto con soffione anticalcare con snodo. 450x315 mm.

Stropní sprchové ramínko s kropítkem se systémem proti usaz. vod. kamene s kloubem. 450x315 mm.



03443203

402,00

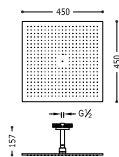

Ceiling shower arm with antilime shower head with ball joint. 450x450 mm.

Braccio doccia a soffitto con soffione anticalcare con snodo. 450x450 mm.

Stropní sprchové ramínko s křopítkem se systémem proti usaz. vod. kamene s kloubem. 450x450 mm.



03443205

419,00

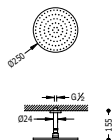

Ceiling shower arm with antilime shower head with ball joint. Ø 250 mm.

Braccio doccia a soffitto con soffione anticalcare con snodo. Ø 250 mm.

Stropní sprchové ramínko s křopítkem se systémem proti usaz. vod. kamene s kloubem. Ø 250 mm.



134221

144,00

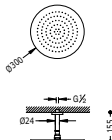

Ceiling shower arm with antilime shower head with ball joint. Ø 300 mm.

Braccio doccia a soffitto con soffione anticalcare con snodo. Ø 300 mm.

Stropní sprchové ramínko s křopítkem se systémem proti usaz. vod. kamene s kloubem. Ø 300 mm.



134331

239,00

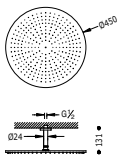

Ceiling shower arm with antilime shower head with ball joint. Ø 450 mm.

Braccio doccia a soffitto con soffione anticalcare con snodo. Ø 450 mm.

Stropní sprchové ramínko s křopítkem se systémem proti usaz. vod. kamene s kloubem. Ø 450 mm.



29943204

378,00

SLIDING BAR | BARRA DI SCORRIMENTO | POSUVNÁ TYČ

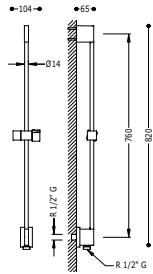

Sliding bar with wall water intake
Ø 14 mm. Long. 760 mm.

Barra di scorrimento con presa d'acqua a parete
Ø 14 mm. Lunga 760 mm.

Posuvná tyč s nástěnným přívodem vody
Ø 14 mm. Délka 760 mm.

	03493299	114,00
	03493299NM	190,00
	03493299BM	190,00
	03493299AC	190,00

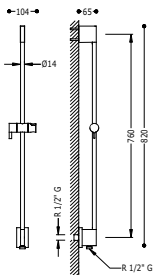

Sliding bar with wall water intake
Ø 14 mm. Long. 760 mm.

Barra di scorrimento con presa d'acqua a parete
Ø 14 mm. Lunga 760 mm.

Posuvná tyč s nástěnným přívodem vody
Ø 14 mm. Délka 760 mm.

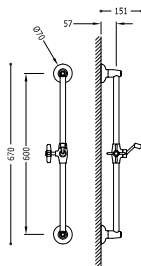

	03493199	109,00
---	----------	---------------



Sliding bar
Ø 20,6 mm. long. 600 mm.

Asta antiscivolo
Ø 20,6 mm. Longo 600 mm.

Posuvná tyč
Ø 20,6 mm, délka 600 mm

	24273201	165,00
	24273201AC	272,00
	24273201LV	231,00
	24273201LM	231,00







Sliding bar with wall water intake

Ø 14 mm. Long. 760 mm. Anti-limescale hand shower. Shower hose SATIN.

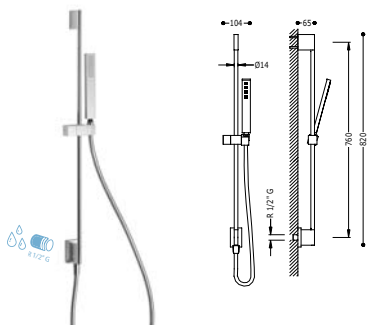
Barra di scorrimento con presa d'acqua a parete
Ø 14 mm. Lunga 760 mm. Doccetta anticalcare. Flessibile satin.

Posuvná tyč s nástěnným přívodem vody
Ø 14 mm. Délka 760 mm. Ruční sprcha, proti usaz. vod. kamene
(202.639.01). Flexi hadice SATIN.



	03493201	165,00
	03493201NM	272,00
	03493201BM	272,00
	03493201AC	272,00



Sliding bar with wall water intake

Ø 14 mm. Long. 760 mm. Anti-limescale hand shower. Shower hose SATIN.

Barra di scorrimento con presa d'acqua a parete
Ø 14 mm. Lunga 760 mm. Doccetta anticalcare. Flessibile satin.

Posuvná tyč s nástěnným přívodem vody
Ø 14 mm. Délka 760 mm. Ruční sprcha, proti usaz. vod. kamene.
Flexi hadice SATIN.

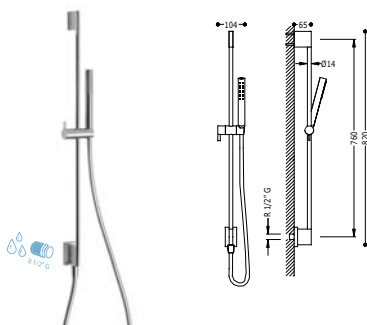

	03493101	152,00
	03493101NM	252,00
	03493101BM	252,00
	03493101AC	252,00



SHOWERS | DOCCIA | SPRCHY

		Antilime shower	20263901	40,35
		Brass		
		Doccetta anticalcare	20263901NM	66,55
		Ottone	20263901BM	66,55
		<i>Sprcha, proti usaz. vod. kamene</i>	20263901AC	66,55
		<i>Materiál Mosaz</i>	20263901KM	66,55
			20263901OR	80,65
			20263901OM	80,65
			20263901NE	66,55
			20263901BL	66,55
			9,5 ...l/m	

		Antilime shower	00663901	37,90
		Brass		
		Doccetta anticalcare	00663901NM	62,50
		Ottone	00663901BM	62,50
		<i>Sprcha, proti usaz. vod. kamene</i>	00663901AC	62,50
		<i>Materiál Mosaz</i>	00663901OR	75,75
			00663901OM	75,75
			00663901NG	62,50
			00663901BL	62,50
			9,5 ...l/m	

		Antilime shower	03463901	31,75
		Brass		
		Doccetta anticalcare	03463901NM	52,40
		Ottone	03463901BM	52,40
		<i>Sprcha, proti usaz. vod. kamene</i>	03463901AC	52,40
			03463901AM	52,40
			03463901NA	52,40
			03463901RO	52,40
			03463901VI	52,40
			03463901FU	52,40
			03463901VE	52,40
			03463901NE	52,40
			03463901BL	52,40
			13 ...l/m	

		Antilime shower	03411601	31,75
		Brass		
		Doccetta anticalcare	03411601NM	52,40
		Ottone	03411601BM	52,40
		<i>Sprcha, proti usaz. vod. kamene</i>	03411601AC	52,40
		<i>Materiál Mosaz</i>	03411601KM	52,40
			03411601OR	63,45
			03411601OM	63,45
			03411601AM	52,40
			03411601NA	52,40
			03411601RO	52,40
			03411601VI	52,40
			03411601FU	52,40
			03411601VE	52,40
			03411601NE	52,40
			03411601BL	52,40
			9,5 ...l/m	

		Massage shower	29974901	27,35
		5 jet types		
		Doccia massaggi		
		5 tipi di getto		
		<i>Masážní sprcha</i>		
		<i>5 typů proudění vody</i>		
			110 ...l/m	
			10	
			12,5	
			12	
			12,5	
			10	

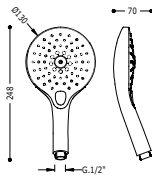

Massage shower
3 jet types

Doccia massaggi
3 tipi di getto

Masážní sprcha
3 typů proudění vody

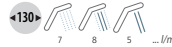

29974904

38,95



Massage shower
3 jet types

Doccia massaggi
3 tipi di getto

Masážní sprcha
3 typů proudění vody



29974905

28,15

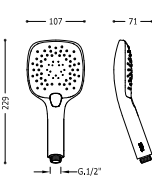

Massage shower
3 jet types

Doccia massaggi
3 tipi di getto

Masážní sprcha
3 typů proudění vody



29974906

30,30

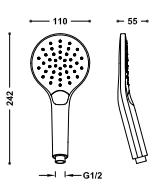

Massage shower ECO-DROP
3 jet types

Doccia massaggi ECO-DROP
3 tipi di getto

Masážní sprcha ECO-DROP
3 typů proudění vody

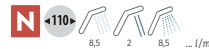

29963112

34,65

- M** 29963112NM 57,15
- M** 29963112BM 57,15
- M** 29963112AC 57,15
- M** 29963112KM 57,15
- M** 29963112KMB 57,15
- Z** 29963112OR 69,25
- Z** 29963112OM 69,25
- Z** 29963112OP 69,25

Buy your box
Acquista il tuo box
Objednejte si svůj box

SELF-SERVICE BOXES / Shower items, thermostatic sets, mixer taps and shower hoses, ideal for your point of sale.

CASSE SELF-SERVICE / Articoli per doccia, set termostatici, miscelatori monocomando o flessibili, ideali per il punto vendita

SAMOOBSLUŽNÉ POKLADNY / Výrobky do sprchy, termostatické sady, jednopákové baterie, kovové hadice, ideální výbava prodejního místa.



www.qtrr.es/promo-box

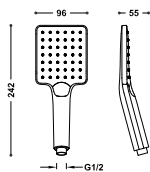

Massage shower ECO-DROP
3 jet types

Doccia massaggio ECO-DROP
3 tipi di getto

Masážní sprcha ECO-DROP
3 typů proudění vody

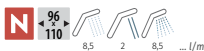

■	29963113	36,40
■	29963113NM	60,00
M	29963113BM	60,00
■	29963113AC	60,00
■	29963113KM	60,00
■	29963113KMB	60,00
■	29963113OR	72,75
■	29963113OM	72,75
■	29963113OP	72,75

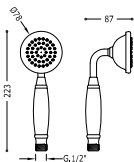

Antilime shower
ceramic handle

Doccetta anticalcare
manico in ceramica

Sprcha, proti usaz. vod. kamene
keramická rukojet



■	29963109	44,30
■	29963109AC	73,10
■	29963109OR	88,60
■	29963109LV	62,05
■	29963109LM	62,05



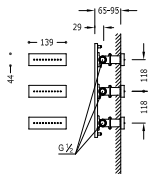

**3 x hydromassage built-in jets
140x45 mm. Brass.**

**3 bocchetta incassate di idromassaggio
140x45 mm. Ottone.**

**3 zapuštěné hydromasážní trysky
140x45 mm. Materiál Mosaz.**



	29951504	517,00
	M 29951504NM	854,00
	M 29951504BM	854,00
	29951504AC	854,00
	24 29951504OR	1.034,00
	24 29951504OM	1.034,00

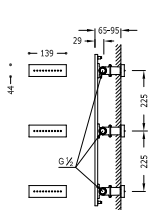

**3 x hydromassage built-in jets
140x45 mm. Brass.**

**3 bocchetta incassate di idromassaggio
140x45 mm. Ottone.**

**3 zapuštěné hydromasážní trysky
140x45 mm. Materiál Mosaz.**



	29951505	546,00
	M 29951505NM	901,00
	M 29951505BM	901,00
	29951505AC	901,00
	24 29951505OR	1.092,00
	24 29951505OM	1.092,00

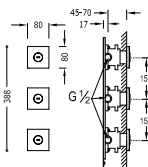

**3 x hydromassage built-in jets
80x80 mm.**

**3 bocchetta incassate di idromassaggio
80x80 mm.**

**3 zapuštěné hydromasážní trysky
80x80 mm.**



	29951506	313,00
--	----------	---------------

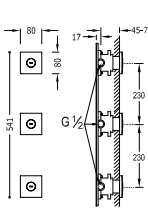

**3 x hydromassage built-in jets
80x80 mm.**

**3 bocchetta incassate di idromassaggio
80x80 mm.**

**3 zapuštěné hydromasážní trysky
80x80 mm.**



	29951507	340,00
--	----------	---------------

**Recommended installation
Installazione consigliata
Doporučená instalace**

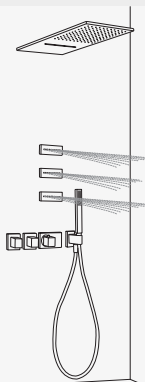

29951504 / 29951506

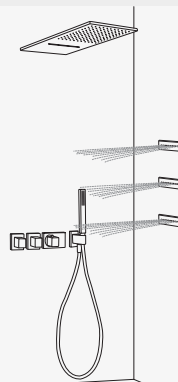

29951505 / 29951507

HOSES | FLESSIBILI | HADICE

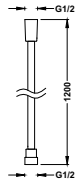

Shower hose SATIN

long. 1,20 m. Ø 14,5 mm. Anti torsion

Flessibile satinato

Longo 1,20 m. Ø 14,5 mm. Girevole antitorsione

Hadice SATIN

délka 1,20 m. Ø 14,5 mm. Otočná, se systémem proti překroucení



	913460912NM	32,30
	913460912BM	32,30
	913460912AC	32,30
	913460912KM	32,30
	913460912KMB	32,30
	913460912OR	39,15
	913460912OM	39,15
	913460912OP	39,15

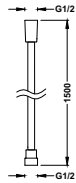

Shower hose SATIN

long. 1,50 m. Ø 14,5 mm. Anti torsion



Flessibile satinato

Longo 1,50 m. Ø 14,5 mm. Girevole antitorsione

Hadice SATIN

délka 1,50 m. Ø 14,5 mm. Otočná, se systémem proti překroucení



	913460915NM	33,25
	913460915BM	33,25
	913460915AC	33,25
	913460915KM	33,25
	913460915KMB	33,25
	913460915OR	40,30
	913460915OM	40,30
	913460915OP	40,30

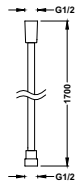

Shower hose SATIN

long. 1,70 m. Ø 14,5 mm. Anti torsion

Flessibile satinato

Longo 1,70 m. Ø 14,5 mm. Girevole antitorsione

Hadice SATIN

délka 1,70 m. Ø 14,5 mm. Otočná, se systémem proti překroucení



	9134609NM	34,25
	9134609BM	34,25
	9134609AC	34,25
	9134609KM	34,25
	9134609KMB	34,25
	9134609OR	41,55
	9134609OM	41,55
	9134609OP	41,55

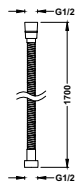

Double interlocked shower hose

long. 1,70 m. Conical nut with ring seal and bolt washer in adapter.
Ten-year warranty

Flessibile doppia graffatura

Longo 1,70 m. Filettatura conica con giunto torico e rosetta integrata nel raccordo. Garanzia 10 anni

Hadice s dvojm zámekm

délka 1,70 m. Kónická matice s těsnícím kroužkem a blokovacím mezikroužkem v přechodce. Záruka deset let



	9134828AC	26,45
	9134828OR	32,05
	9134828LV	26,45
	9134828LM	26,45

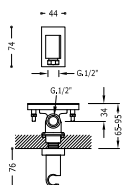

Shower holder BLOCK SYSTEM
with adjustable depth wall water inlet fitting and anti-return valve. Built-in body included

Supporto per doccia BLOCK SYSTEM
con presa d'acqua a parete con profondità regolabile e valvola antiritorno. Corpo incassato incluso.

Úchyt ruční sprchy se stěnovou přípojkou vody BLOCK SYSTEM
s nastavitelným výstupem pro vodu a zpětným ventilem. Včetně podomítkového tělesa.

	20718202	112,00
	20718202NM	185,00
	20718202BM	185,00
	20718202AC	185,00
	20718202OR	225,00
	20718202OM	225,00

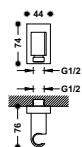

Shower holder
with wall water outlet and check valve.

Supporto per doccia
con presa d'acqua a parete e valvola antiritorno

Úchyt ruční sprchy se stěnovou přípojkou vody s nastavitelným výstupem pro vodu a zpětným ventilem.

	20718201	56,25
	20718201NM	92,85
	20718201BM	92,85
	20718201AC	92,85
	20718201OR	113,00
	20718201OM	113,00

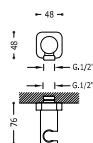

Shower holder
with wall water outlet and check valve.

Supporto per doccia
con presa d'acqua a parete e valvola antiritorno

Úchyt ruční sprchy se stěnovou přípojkou vody s nastavitelným výstupem pro vodu a zpětným ventilem.

	20018201NM	76,35
	20018201BM	76,35
	20018201AC	76,35
	20018201OR	92,50
	20018201OM	92,50
	20018201AM	76,35
	20018201NA	76,35
	20018201RO	76,35
	20018201VI	76,35
	20018201FU	76,35
	20018201VE	76,35
	20018201NE	76,35
	20018201BL	76,35

Adjustable holder

Brass

Supporto orientabile

Ottone

Nastavitelný kulatý držák, kovový
Materiál Mosaz

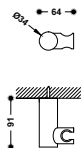

M	06183901NM	41,05
M	06183901BM	41,05
M	06183901AC	41,05
24	06183901OR	49,75
24	06183901OM	49,75
24	06183901AM	41,05
24	06183901NA	41,05
24	06183901RO	41,05
24	06183901VI	41,05
24	06183901FU	41,05
24	06183901VE	41,05
24	06183901NE	41,05
24	06183901BL	41,05

Shower holder with wall entrance

Supporto per doccia con presa a parete

Úchyt ruční sprchy se stěnovou přípojkou vody s nástěnným vodním přívodem

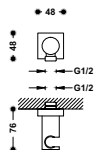

M	06118201NM	76,35
M	06118201BM	76,35
M	06118201AC	76,35
M	06118201KM	76,35
M	06118201KMB	76,35
24	06118201OR	92,50
24	06118201OM	92,50
24	06118201OP	92,50

Shower holder with wall entrance

Supporto per doccia con presa a parete

Úchyt ruční sprchy se stěnovou přípojkou vody s nástěnným vodním přívodem

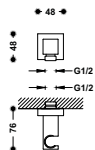

M	00618201NM	92,80
M	00618201BM	92,80
M	00618201AC	92,80
24	00618201OR	113,00
24	00618201OM	113,00

Shower holder with wall entrance

Supporto per doccia con presa a parete

Úchyt ruční sprchy se stěnovou přípojkou vody s nástěnným vodním přívodem

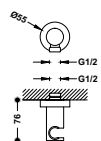

M	20518201NM	76,35
M	20518201BM	76,35
M	20518201AC	76,35
M	20518201KM	76,35
M	20518201KMB	76,35
24	20518201OR	92,50
24	20518201OM	92,50
24	20518201OP	92,50

Adjustable holder

Brass

Supporto orientabile

Ottone

Nastavitelný čtvercový držák, kovový
Materiál Mosaz

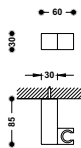

M	107839NM	43,30
M	107839BM	43,30
M	50783903	43,30
24	107839OR	52,45
24	107839OM	52,45

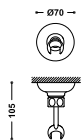

Adjustable holder





Brass

Supporto orientabile

Ottone

Nastavitelný držák

Materiál Mosaz

	29963910	29,90
	29963910AC	49,30
	29963910OR	59,75
	29963910LV	41,85
	29963910LM	41,85

338 2 ways | vie | cestná



346 / 3 ways | vie | cestná



351 / Extensions | Prolungha | Prodlužka



THERMOSTATICALLY-CONTROLLED SETS GRUPPI TERMOSTATICI TERMOSTATICKÉ SOUPRAVY



www.qtrr.es/termostatic



**Chrome
Cromato**
Chrom



**Matt Black
Nero Opaco**
Cerná mat



**Matt White
Bianco Opaco**
Bílá mat



**Steel
Acciaio**
Ocel



**Orange-Chrome
Arancione-Cromato**
Oranžová-Chrom



**Red-Chrome
Rosso-Cromato**
Červená-Chrom



**Purple-Chrome
Viola-Cromato**
Fialová-Chrom



**Green-Chrome
Verde-Cromato**
Zelená-Chrom



**Black-Chrome
Nero-Cromato**
Černá-Chrom



**White-Chrome
Bianco-Cromato**
Bílá-Chrom



Quality and total control

Qualità e controllo totale

Kvalita a naprostá kontrola

With endless possible combinations, based on rounded or square designs for showers and bathtubs, TRES has become an expert in the manufacture of shower units that add distinction to the bathroom and enable users to spend enjoyable relaxing moments beneath the shower. With quality finishes and multiple functions to make showering or bathing the favorite time of day.

Con infinite combinazioni possibili, seguendo design tondeggianti o squadrati, sia per la doccia che per la vasca da bagno, TRES si è specializzata nella fabbricazione di gruppi doccia che conferiscono personalità al bagno e offrono grandi momenti di relax nell'acqua. Con finiture di qualità e molteplici funzioni per rendere la doccia o il bagno il momento preferito della giornata.

Díky nespočtu možných kombináci, kulatým i hranatým tvarům jak sprch, tak i van, se společnost TRES stala specialistou na výrobu sprchových souprav, které koupelnám dodávají na příznivém vzhledu a umožňují relaxaci s vodou. S kvalitním provedením a velkým množstvím funkcí učiní ze sprchování příjemný každodenní zážitek.



Touch-cool®

The internal water circuit makes the cold water come in contact with the surface, meaning the tap stays cool when touched and preventing burns.

Il circuito interno dell'acqua fa in modo che sia l'acqua fredda a toccare la superficie e in questo modo il rubinetto rimane sempre freddo al tatto, evitando bruciate.

Vnitřní oběh vody způsobí kontakt mezi studenou vodou a povrchem, díky čemuž zůstává baterie vždy chladná na dotek a nedochází k popálení.



Easy-clean®

TRES offers the possibility of cleaning the cartridge easily in the event of blockage, without losing its calibration.

TRES offre la possibilità di pulire facilmente la cartuccia in caso di ingorgo senza perderne la calibratura.

V případě zanesení nabízí TRES možnost jednoduchého čištění kartuše bez ztráty kalibrace.



Tres Instant 77®

Tres Instant 57®

The cartridge ensures a constant flow of water at the desired temperature ± 1 degree, in spite of pressure and/or temperature changes. Designed for Legionella disinfection.

La cartuccia assicura una portata d'acqua costante alla temperatura desiderata di ± 1 grado in caso di variazioni di pressione e/o temperatura. Concepita per la disinfezione dalla legionella.

Kartuš zaručuje stálý průtok vody zvolené teploty, ± 1 stupně, v závislosti na změně tlaku a/nebo teploty. Vhodné k dezinfekci legionely.

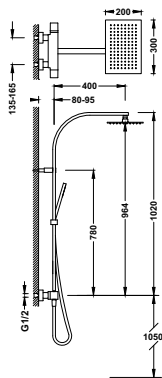

Wall thermostatic shower mixer

- Fixed shower head 300x200 mm. with ball joint. Stainless material.
- Anti-limescale hand shower.
- Shower hose SATIN.
- Diverter integrated in the flow control.

Set doccia termostatica

- Doccia fissa 300x200 mm. con snodo. Materiale acciaio inossidabile.
- Doccetta anticalcare.
- Flessibile satin.
- Invertitore integrato nel regolatore di portata.

Souprava termostatické sprchové baterie

- Pevná sprcha 300x200 mm. s kloubem. Materiál nerezová ocel.
- Ruční sprcha, proti usaz. vod. kamene.
- Flexi hadice SATIN.
- Přepínač zabudovaný v regulaci průtoku.

910616110	910616153	
29931201NM	910616116	
29931201BM	910616114	

	2019501	858,00
	2019501NM	1.416,00
	2019501BM	1.416,00
	2019501AC	1.416,00
	2019501NE	1.416,00
	2019501BL	1.416,00



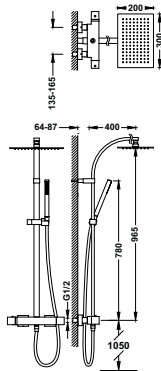

Wall thermostatic shower mixer

- Fixed shower head 300x200 mm. with ball joint. Stainless material.
- Anti-limescale hand shower.
- Satin hose.
- Diverter integrated in the flow control.

Set doccia termostatica

- Doccia fissa 300x200 mm. con snodo. Materiale acciaio inossidabile.
- Doccetta anticalcare.
- Tubo flessibile satin.
- Invertitore integrato nel regolatore di portata.

Souprava termostatické sprchové baterie

- Pevná sprcha 300x200 mm. s kloubelem. Materiál nerezová ocel.
- Ruční sprcha, proti usaz. vod. kamene.
- Flexi hadice SATIN.
- Prepínač zabudovaný v regulaci průtoku.



00739504

742,00

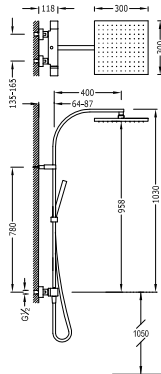

Wall thermostatic shower mixer

- Fixed shower head 300x300 mm. with ball joint. Brass.
- Anti-limescale hand shower.
- Shower hose SATIN.
- Diverter integrated in the flow control.

Set doccia termostatica

- Doccia fissa 300x300 mm. con snodo. Ottone.
- Doccetta anticalcare.
- Flessibile satin.
- Invertitore integrato nel regolatore di portata.

Souprava termostatické sprchové baterie

- Pevná sprcha 300x300 mm. s kloubelem. Materiál mosaz.
- Ruční sprcha, proti usaz. vod. kamene.
- Flexi hadice SATIN.
- Prepínač zabudovaný v regulaci průtoku.



910616110 910616153
910616110NM 910616116
910616110SM 910616114

107395

796,00

M 00739502NM

1.314,00

M 00739502BM

1.314,00

00739502AC

1.314,00

607395

1.314,00

407395

1.314,00

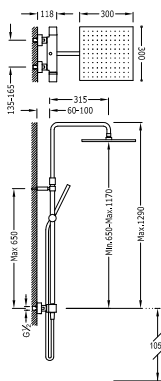

Wall thermostatic shower mixer

- Fixed shower head 300x300 mm. with ball joint. Brass.
- Anti-limescale hand shower.
- Shower hose SATIN.
- Telescopic bar.
- Diverter integrated in the flow control.

Set doccia termostatica

- Doccia fissa 300x300 mm. con snodo. Ottone.
- Doccetta anticalcare.
- Flessibile satin.
- Asta telescopica.
- Invertitore integrato nel regolatore di portata.

Souprava termostatické sprchové baterie

- Pevná sprcha 300x300 mm. s kloubelem. Materiál mosaz.
- Ruční sprcha, proti usaz. vod. kamene.
- Flexi hadice SATIN.
- Teleskopická tyč.
- Prepínač zabudovaný v regulaci průtoku.



00719501

869,00

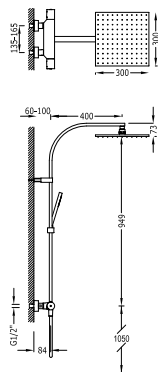

Wall thermostatic shower mixer

- Fixed shower head 300x300 mm. with ball joint.
- Anti-limescale hand shower.
- Flexible satin.
- Diverter integrated in the flow control.

Set doccia termostatica

- Doccia fissa 300x300 mm. con snodo.
- Doccetta anticalcare.
- Flessibile satin.
- Invertitore integrato nel regolatore di portata.

Souprava termostatické sprchové baterie

- Pevná sprcha 300x300 mm. s kloubem.
- Ruční sprcha, proti usaz. vod. kamene.
- Flexi hadice SATIN.
- Přepínač zabudovaný v regulaci průtoku.

29919503
29919503NM
29919503BM
29919503AC

21139501 **695,00**

M 21139501NM **1.147,00**

M 21139501BM **1.147,00**

M 21139501AC **1.147,00**

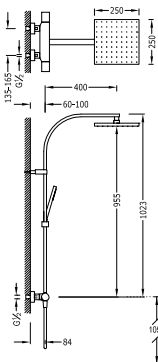

Wall thermostatic shower mixer

- Fixed shower head 250x250 mm. with ball joint.
- Anti-limescale hand shower.
- Shower hose SATIN.
- Diverter integrated in the flow control.

Set doccia termostatica

- Doccia fissa 250x250 mm. con snodo.
- Doccetta anticalcare.
- Flessibile satin.
- Invertitore integrato nel regolatore di portata.

Souprava termostatické sprchové baterie

- Pevná sprcha 250x250 mm. s kloubem.
- Ruční sprcha, proti usaz. vod. kamene.
- Flexi hadice SATIN.
- Přepínač zabudovaný v regulaci průtoku.

20539501 **658,00**

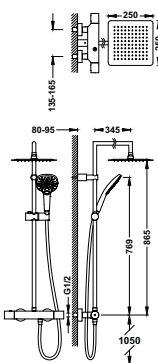

Wall thermostatic shower mixer

- Fixed shower head 250x250 mm. with ball joint. Stainless material.
- Anti-limescale hand shower (3 fonctions)
- Satin hose.
- Diverter integrated in the flow control.

Set doccia termostatica

- Doccia fissa 250x250 mm. con snodo. Materiale acciaio inossidabile.
- Doccetta anticalcare (3 funzioni).
- Tubo flessibile satin.
- Invertitore integrato nel regolatore di portata.

Souprava termostatické sprchové baterie

- Pevná sprcha 250x250 mm. s kloubem. Materiál nerezová ocel.
- Ruční sprcha (3 funkce) proti usaz. vod. Kamene
- Flexi hadice SATIN.
- Přepínač zabudovaný v regulaci průtoku.

20539502 **573,00**



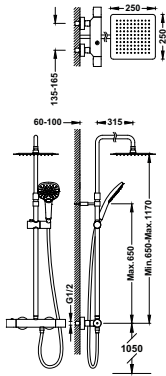

Wall thermostatic shower mixer

- Fixed shower head 250x250 mm. with ball joint. Stainless material.
- Anti-limescale hand shower (3 fonctions)
- Satin hose.
- Telescopic bar.
- Diverter integrated in the flow control.

Set doccia termostatica

- Doccia fissa 250x250 mm. con snodo. Materiale acciaio inossidabile.
- Doccetta anticalcare (3 funzioni).
- Flessibile satin.
- Asta telescopica.
- Invertitore integrato nel regolatore di portata.

Souprava termostatické sprchové baterie

- Pevná sprcha 250x250 mm. s kloubelem. Materiál nerezová ocel.
- Ruční sprcha (3 funkce) proti usaz. vod. Kamene
- Flexi hadice SATIN.
- Teleskopická tyč.
- Přepínač zabudovaný v regulaci průtoku.



20538502

624,00

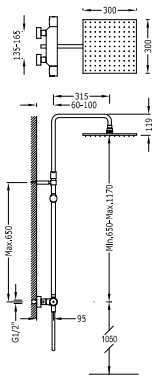

Wall thermostatic shower mixer

- Fixed shower head 300x300 mm. with ball joint.
- Anti-limescale hand shower.
- Flexible satin.
- Telescopic bar.
- Diverter integrated in the flow control.

Set doccia termostatica

- Doccia fissa 300x300 mm. con snodo.
- Doccetta anticalcare.
- Flessibile satin.
- Asta telescopica.
- Invertitore integrato nel regolatore di portata.

Souprava termostatické sprchové baterie

- Pevná sprcha 300x300 mm. s kloubelem.
- Ruční sprcha, proti usaz. vod. Kamene.
- Flexi hadice SATIN.
- Teleskopická tyč.
- Přepínač zabudovaný v regulaci průtoku.

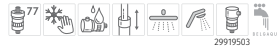

21139502

663,00

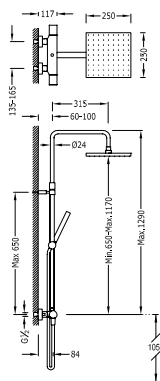

Wall thermostatic shower mixer

- Fixed shower head 250x250 mm. with ball joint.
- Anti-limescale hand shower.
- Shower hose SATIN.
- Telescopic bar.
- Diverter integrated in the flow control.

Set doccia termostatica

- Doccia fissa 250x250 mm. con snodo.
- Doccetta anticalcare.
- Flessibile satin.
- Asta telescopica.
- Invertitore integrato nel regolatore di portata.

Souprava termostatické sprchové baterie

- Pevná sprcha 250x250 mm. s kloubelem.
- Ruční sprcha, proti usaz. vod. kamene.
- Flexi hadice SATIN.
- Teleskopická tyč.
- Přepínač zabudovaný v regulaci průtoku.



20538501

624,00

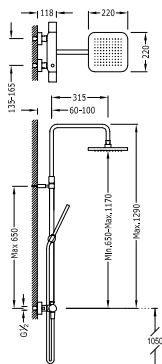

Wall thermostatic shower mixer

- Fixed shower head 220x220 mm. with ball joint.
- Anti-limescale hand shower.
- Shower hose SATIN.
- Telescopic bar.
- Diverter integrated in the flow control.

Set doccia termostatica

- Doccia fissa 220x220 mm. con snodo.
- Doccetta anticalcare.
- Flessibile satin.
- Asta telescopica.
- Invertitore integrato nel regolatore di portata.

Souprava termostatické sprchové baterie

- Pevná sprcha 220x220 mm. s kloubem.
- Ruční sprcha, proti usaz. vod. kamene.
- Flexi hadice SATIN.
- Teleskopická tyč.
- Přepínač zabudovaný v regulaci průtoku.



29919503	29919503FU	
29919503AM	29919503VE	
29919503MA	29919503NE	
29919503RO	29919503BL	
29919503VI		

20019501	657,00
20019501AM	1.085,00
20019501NA	1.085,00
20019501RO	1.085,00
20019501VI	1.085,00
20019501FU	1.085,00
20019501VE	1.085,00
20019501NE	1.085,00
20019501BL	1.085,00

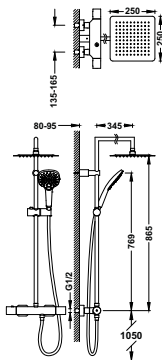

Wall thermostatic shower mixer

- Fixed shower head 250x250 mm. with ball joint.
- Anti-limescale hand shower (3 functions)
- Shower hose SATIN.
- Diverter integrated in the flow control.

Set doccia termostatica

- Doccia fissa 250x250 mm. con snodo.
- Doccetta anticalcare (3 funzioni).
- Flessibile satin.
- Invertitore integrato nel regolatore di portata.

Souprava termostatické sprchové baterie

- Pevná sprcha 250x250 mm. s kloubem.
- Ruční sprcha (3 funkce) proti usaz. vod. Kamene
- Flexi hadice SATIN.
- Přepínač zabudovaný v regulaci průtoku.



20019502	606,00
----------	--------

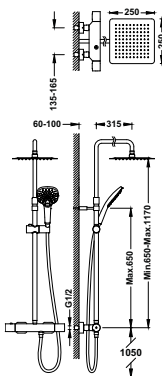

Wall thermostatic shower mixer

- Fixed shower head 250x250 mm. with ball joint.
- Anti-limescale hand shower (3 fonctions)
- Shower hose SATIN.
- Telescopic bar.
- Diverter integrated in the flow control.

Set doccia termostatica

- Doccia fissa 250x250 mm. con snodo.
- Doccetta anticalcare (3 funzioni).
- Flessibile satin.
- Asta telescopica.
- Invertitore integrato nel regolatore di portata.

Souprava termostatické sprchové baterie

- Pevná sprcha 250x250 mm. s kloubem.
- Ruční sprcha (3 funkce) proti usaz. vod. Kamene
- Flexi hadice SATIN.
- Teleskopická tyč.
- Přepínač zabudovaný v regulaci průtoku.



20019503	657,00
----------	--------

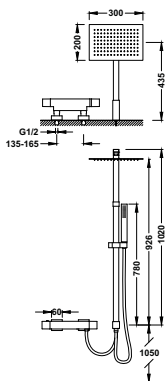

Wall thermostatic shower mixer

- Fixed shower head 300x200 mm. with ball joint. Stainless material.
- Anti-limescale hand shower.
- Shower hose SATIN.

Set doccia termostatica

- Doccia fissa 300x200 mm. con snodo. Materiale acciaio inossidabile.
- Doccetta anticalcare.
- Flessibile satin.

Souprava termostatické sprchové baterie

- Pevná sprcha 300x200 mm. s kloubem. Materiál nerezová ocel.
- Ruční sprcha, proti usaz. vod. kamene.
- Flexi hadice SATIN.



20238501

662,00

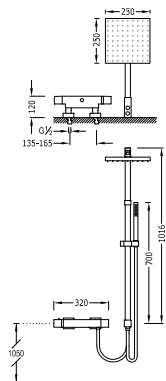

Wall thermostatic shower mixer

- Fixed shower head 250x250 mm. with ball joint.
- Anti-limescale hand shower.
- Shower hose SATIN.

Set doccia termostatica

- Doccia fissa 250x250 mm. con snodo.
- Doccetta anticalcare.
- Flessibile satin.

Termostatický sprchový set

- Hlavový sprcha 250x250 mm. s kloubem.
- Ruční sprcha, proti usaz. vod. kamene.
- Flexi hadice SATIN.



00738501

556,00

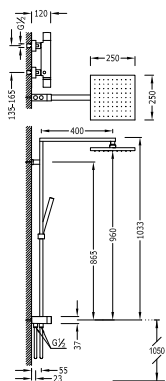

Wall thermostatic shower mixer

- Fixed shower head 250x250 mm. with ball joint.
- Anti-limescale hand shower.
- Shower hose SATIN.

Set doccia termostatica

- Doccia fissa 250x250 mm. con snodo.
- Doccetta anticalcare.
- Flessibile satin.

Souprava termostatické sprchové baterie

- Pevná sprcha 250x250 mm. s kloubem.
- Ruční sprcha, proti usaz. vod. kamene.
- Flexi hadice SATIN.



107964

535,00

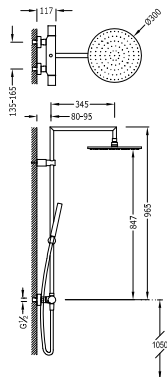

Wall thermostatic shower mixer

- Fixed shower head Ø 300 mm. with ball joint. Brass.
- Anti-limescale hand shower.
- Shower hose SATIN.
- Diverter integrated in the flow control.

Set doccia termostatica

- Doccia fissa Ø 300 mm. con snodo. Ottone.
- Doccetta anticalcare.
- Flessibile satin.
- Invertitore integrato nel regolatore di portata.

Souprava termostatické sprchové baterie

- Pevná sprcha Ø 300 mm. s kloboum. Materiál mosaz.
- Ruční sprcha, proti usaz. vod. kamene.
- Flexí hadice SATIN.
- Přepínač zabudovaný v regulaci průtoku.



29919503

06139301

669,00

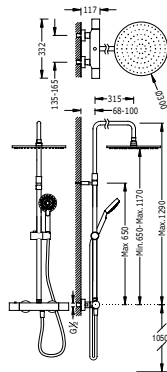

Wall thermostatic shower mixer

- Fixed shower head Ø 300 mm. with ball joint. Brass.
- Anti-limescale hand shower.
- Shower hose SATIN.
- Telescopic bar.
- Diverter integrated in the flow control.

Set doccia termostatica

- Doccia fissa Ø 300 mm. con snodo. Ottone.
- Doccetta anticalcare.
- Flessibile satin.
- Asta telescopica.
- Invertitore integrato nel regolatore di portata.

Souprava termostatické sprchové baterie

- Pevná sprcha Ø 300 mm. s kloboum. Materiál mosaz.
- Ruční sprcha, proti usaz. vod. kamene.
- Flexí hadice SATIN.
- Teleskopická tyč.
- Přepínač zabudovaný v regulaci průtoku.



29919503

06121001

708,00

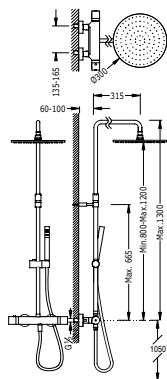

Wall thermostatic shower mixer

- Fixed shower head Ø 300 mm. with ball joint. Brass.
- Anti-limescale hand shower.
- Shower hose SATIN.
- Telescopic bar.
- Diverter integrated in the flow control.

Set doccia termostatica

- Doccia fissa Ø 300 mm. con snodo. Ottone.
- Doccetta anticalcare.
- Flessibile satin.
- Asta telescopica.
- Invertitore integrato nel regolatore di portata.

Souprava termostatické sprchové baterie

- Pevná sprcha Ø 300 mm. s kloboum. Materiál mosaz.
- Ruční sprcha, proti usaz. vod. kamene.
- Flexí hadice SATIN.
- Teleskopická tyč.
- Přepínač zabudovaný v regulaci průtoku.



29919503

26121001

721,00

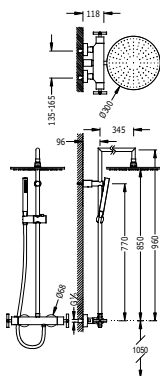

Wall thermostatic shower mixer

- Fixed shower head Ø 300 mm. with ball joint. Brass.
- Anti-limescale hand shower.
- Shower hose SATIN.
- Diverter integrated in the flow control.

Set doccia termostatica

- Doccia fissa Ø 300 mm. con snodo. Ottone.
- Doccetta anticalcare.
- Flessibile satin.
- Invertitore integrato nel regolatore di portata.

Souprava termostatické sprchové baterie

- Pevná sprcha Ø 300 mm. s kloubelem. Materiál mosaz.
- Ruční sprcha, proti usaz. vod. kamene.
- Flexi hadice SATIN.
- Přepínač zabudovaný v regulaci průtoku.



29916301

06339301

714,00

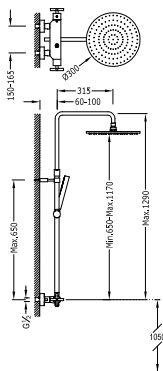

Wall thermostatic shower mixer

- Fixed shower head Ø 300 mm. with ball joint. Brass.
- Anti-limescale hand shower.
- Shower hose SATIN.
- Telescopic bar.
- Diverter integrated in the flow control.

Set doccia termostatica

- Doccia fissa Ø 300 mm. con snodo. Ottone.
- Doccetta anticalcare.
- Flessibile satin.
- Asta telescopica.
- Invertitore integrato nel regolatore di portata.

Souprava termostatické sprchové baterie

- Pevná sprcha Ø 300 mm. s kloubelem. Materiál mosaz.
- Ruční sprcha, proti usaz. vod. kamene.
- Flexi hadice SATIN.
- Teleskopická tyč.
- Přepínač zabudovaný v regulaci průtoku.



29916301

06321101

753,00

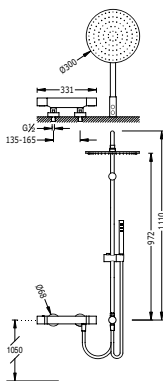

Wall thermostatic shower mixer

- Fixed shower head Ø 300 mm. with ball joint. Brass.
- Anti-limescale hand shower.
- Shower hose SATIN.

Set doccia termostatica

- Doccia fissa Ø 300 mm. con snodo. Ottone.
- Doccetta anticalcare.
- Flessibile satin.

Souprava termostatické sprchové baterie

- Pevná sprcha Ø 300 mm. s kloubelem. Materiál mosaz.
- Ruční sprcha, proti usaz. vod. kamene.
- Flexi hadice SATIN.



29919503

06138501

515,00

THERMOSTATICALLY-CONTROLLED - (3 WAYS) | TERMOSTATICHE - (3 VIE) | TERMOSTATICKÉ - (3 CESTNÁ)

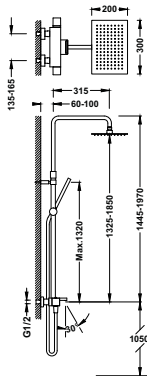

Wall thermostatic bath mixer (3 ways)

- Fixed shower head 300x200 mm. with ball joint. Stainless material.
- Anti-limescale hand shower.
- Shower hose SATIN.
- Telescopic bar.
- Diverter integrated in the flow control.

Idrodoccia termostatica (3 vie)

- Doccia fissa 300x200 mm. con snodo. Materiale acciaio inossidabile.
- Doccetta anticalcare.
- Flessibile satin.
- Asta telescopica.
- Invertitore integrato nel regolatore di portata.

Souprava termostatické baterie pro vanu-sprchu (3-cestná)

- Pevná sprcha 300x200 mm. s kloboum. Materiál nerezová ocel.
- Ruční sprcha, proti usaz. vod. kamene.
- Flexi hadice SATIN.
- Teleskopická tyč.
- Přepínač zabudovaný v regulaci průtoku.



20231201

886,00

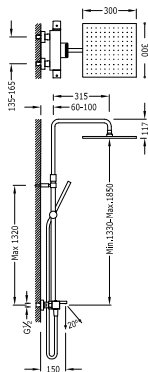

Wall thermostatic bath mixer (3 ways)

- Fixed shower head 300x300 mm. with ball joint. Brass.
- Anti-limescale hand shower.
- Shower hose SATIN.
- Telescopic bar.
- Diverter integrated in the flow control.

Idrodoccia termostatica (3 vie)

- Doccia fissa 300x300 mm. con snodo. Ottone.
- Doccetta anticalcare.
- Flessibile satin.
- Asta telescopica.
- Invertitore integrato nel regolatore di portata.

Souprava termostatické baterie pro vanu-sprchu (3-cestná)

- Pevná sprcha 300x300 mm. s kloboum. Materiál mosaz.
- Ruční sprcha, proti usaz. vod. kamene.
- Flexi hadice SATIN.
- Teleskopická tyč.
- Přepínač zabudovaný v regulaci průtoku.

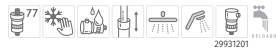

00731201

869,00

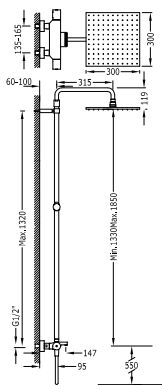

Wall thermostatic bath mixer (3 ways)

- Fixed shower head 300x300 mm. with ball joint.
- Anti-limescale hand shower.
- Shower hose SATIN.
- Telescopic bar.
- Diverter integrated in the flow control.

Idrodoccia termostatica (3 vie)

- Doccia fissa 300x300 mm. con snodo.
- Doccetta anticalcare.
- Flessibile satin.
- Asta telescopica.
- Invertitore integrato nel regolatore di portata.

Souprava termostatické baterie pro vanu-sprchu (3-cestná)

- Pevná sprcha 300x300 mm. s kloboum.
- Ruční sprcha, proti usaz. vod. Kamene.
- Flexi hadice SATIN.
- Teleskopická tyč.
- Přepínač zabudovaný v regulaci průtoku.

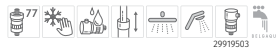

21131201

738,00

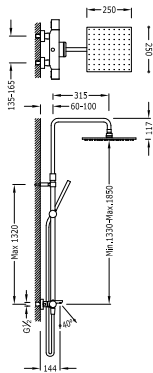

Wall thermostatic bath mixer (3 ways)

- Fixed shower head 250x250 mm. with ball joint.
- Anti-limescale hand shower.
- Shower hose SATIN.
- Telescopic bar.
- Diverter integrated in the flow control.

Idrodoccia termostatica (3 vie)

- Doccia fissa 250x250 mm. con snodo.
- Doccetta anticalcare.
- Flessibile satin.
- Asta telescopica.
- Invertitore integrato nel regolatore di portata.

Souprava termostatické baterie pro vanu-sprchu (3-cestná)

- Pevná sprcha 250x250 mm. s kloubem.
- Ruční sprcha, proti usaz. vod. kamene.
- Flexi hadice SATIN.
- Teleshopická tyč.
- Přepínač zabudovaný v regulaci průtoku.



20531201

705,00

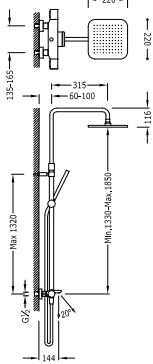

Wall thermostatic bath mixer (3 ways)

- Fixed shower head 220x220 mm. with ball joint.
- Anti-limescale hand shower.
- Shower hose SATIN.
- Telescopic bar.
- Diverter integrated in the flow control.

Idrodoccia termostatica (3 vie)

- Doccia fissa 220x220 mm. con snodo.
- Doccetta anticalcaire.
- Flessibile satin.
- Asta telescopica.
- Invertitore integrato nel regolatore di portata.

Souprava termostatické baterie pro vanu-sprchu (3-cestná)

- Pevná sprcha 220x220 mm. s kloubem.
- Ruční sprcha, proti usaz. vod. kamene.
- Flexi hadice SATIN.
- Teleshopická tyč.
- Přepínač zabudovaný v regulaci průtoku.



20031201

705,00

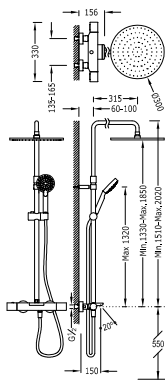

Wall thermostatic bath mixer (3 ways)

- Fixed shower head Ø 300 mm. with ball joint. Brass.
- Anti-limescale hand shower.
- Shower hose SATIN.
- Telescopic bar.
- Diverter integrated in the flow control.

Idrodoccia termostatica (3 vie)

- Doccia fissa Ø 300 mm. con snodo. Ottone.
- Doccetta anticalcare.
- Flessibile satin.
- Asta telescopica.
- Invertitore integrato nel regolatore di portata.

Souprava termostatické baterie pro vanu-sprchu (3-cestná)

- Pevná sprcha Ø 300 mm. s kloubem. Materiál mosaz.
- Ruční sprcha, proti usaz. vod. kamene.
- Flexi hadice SATIN.
- Teleshopická tyč.
- Přepínač zabudovaný v regulaci průtoku.



06231201

787,00

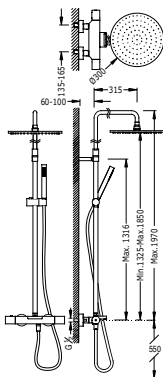

Wall thermostatic bath mixer (3 ways)

- Fixed shower head Ø 300 mm. with ball joint. Brass.
- Anti-limescale hand shower.
- Shower hose SATIN.
- Telescopic bar.
- Diverter integrated in the flow control.

Iidroccia termostatica (3 vie)

- Doccia fissa Ø 300 mm. con snodo. Ottone.
- Doccetta anticalcare.
- Flessibile satin.
- Asta telescopica.
- Invertitore integrato nel regolatore di portata.

Souprava termostatické baterie pro vanu-sprchu (3-cestná)

- Pevná sprcha Ø 300 mm. s kloubem. Materiál mosaz.
- Ruční sprcha, proti usaz. vod. kamene.
- Flexi hadice SATIN.
- Teleskopická tyč.
- Přepínač zabudovaný v regulaci průtoku.



26231201

802,00

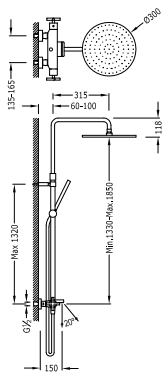

Wall thermostatic bath mixer (3 ways)

- Fixed shower head Ø 300 mm. with ball joint. Brass.
- Anti-limescale hand shower.
- Shower hose SATIN.
- Telescopic bar.
- Diverter integrated in the flow control.

Iidroccia termostatica (3 vie)

- Doccia fissa Ø 300 mm. con snodo. Ottone.
- Doccetta anticalcare.
- Flessibile satin.
- Asta telescopica.
- Invertitore integrato nel regolatore di portata.

Souprava termostatické baterie pro vanu-sprchu (3-cestná)

- Pevná sprcha Ø 300 mm. s kloubem. Materiál mosaz.
- Ruční sprcha, proti usaz. vod. kamene.
- Flexi hadice SATIN.
- Teleskopická tyč.
- Přepínač zabudovaný v regulaci průtoku.



06331201

787,00

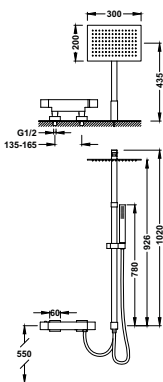

Wall thermostatic bath mixer

- Fixed shower head 300x200 mm. with ball joint. Stainless material.
- Anti-limescale hand shower.
- Shower hose SATIN.

Iidroccia termostatica

- Doccia fissa 300x200 mm. con snodo. Materiale acciaio inossidabile.
- Doccetta anticalcare.
- Flessibile satin.

Souprava termostatické baterie pro vanu-sprchu

- Pevná sprcha 300x200 mm. s kloubem. Materiál nerezová ocel.
- Ruční sprcha, proti usaz. vod. kamene.
- Flexi hadice SATIN.



20238502

715,00

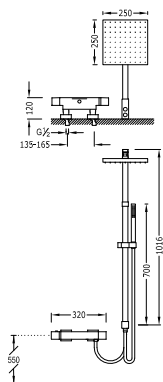

Wall thermostatic bath mixer

- Fixed shower head 250x250 mm. with ball joint.
- Anti-limescale hand shower.
- Shower hose SATIN.
- Diverter integrated in the flow control.

Idrodoccia termostatica

- Doccia fissa 250x250 mm. con snodo.
- Doccetta anticalcare.
- Flessibile satin.
- Invertitore integrato nel regolatore di portata.

Souprava termostatické baterie pro vanu-sprchu

- Pevná sprcha 250x250 mm. s kloubem.
- Ruční sprcha, proti usaz. vod. kamene.
- Flexi hadice SATIN.
- Přepínač zabudovaný v regulaci průtoku.



910616110

00738502

608,00

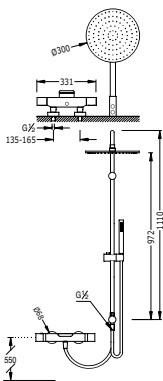

Wall thermostatic bath mixer

- Fixed shower head Ø 300 mm. with ball joint. Brass.
- Anti-limescale hand shower.
- Shower hose SATIN.
- Diverter integrated in the flow control.

Idrodoccia termostatica

- Doccia fissa Ø 300 mm. con snodo. Ottone.
- Doccetta anticalcare.
- Flessibile satin.
- Invertitore integrato nel regolatore di portata.

Souprava termostatické baterie pro vanu-sprchu

- Pevná sprcha Ø 300 mm. s kloubem. Materiál mosaz.
- Ruční sprcha, proti usaz. vod. kamene.
- Flexi hadice SATIN.
- Přepínač zabudovaný v regulaci průtoku.



29919503

06138502

568,00

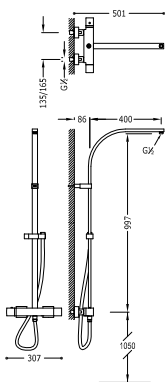

Wall thermostatic shower mixer

Without accessories. To complete with a wall shower and a hand shower. Diverter integrated in the flow control.

Set doccia termostatica

Senza accessori. Da completare con un soffione e una doccetta. Invertitore integrato nel regolatore di portata.

Souprava termostatické sprchové baterie

Bez doplňků. Pro získání kompletní sady vyberte vhodnou hlavovou a ruční sprchu. Přepínač zabudovaný v regulaci průtoku.



910616110

00749501

613,00

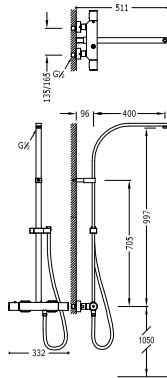

Wall thermostatic shower mixer

Without accessories. To complete with a wall shower and a hand shower. Diverter integrated in the flow control.

Set doccia termostatica

Senza accessori. Da completare con un soffione e una doccetta. Invertitore integrato nel regolatore di portata.

Souprava termostatické sprchové baterie

Bez doplňků. Pro získání kompletní sady vyberte vhodnou hlavovou a ruční sprchu. Přepínač zabudovaný v regulaci průtoku.



20549501

591,00

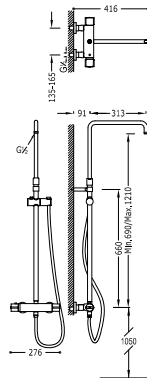

Wall thermostatic shower mixer

Without accessories. To complete with a wall shower and a hand shower. Diverter integrated in the flow control.

Set doccia termostatica

Senza accessori. Da completare con un soffione e una doccetta. Invertitore integrato nel regolatore di portata.

Souprava termostatické sprchové baterie

Bez doplňků. Pro získání kompletní sady vyberte vhodnou hlavovou a ruční sprchu. Přepínač zabudovaný v regulaci průtoku.



09049501

502,00

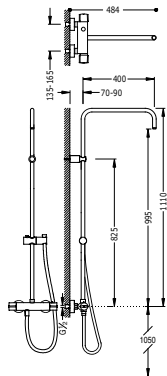

Wall thermostatic shower mixer

Without accessories. To complete with a wall shower and a hand shower. Diverter integrated in the flow control.

Set doccia termostatica

Senza accessori. Da completare con un soffione e una doccetta. Invertitore integrato nel regolatore di portata.

Souprava termostatické sprchové baterie

Bez doplňků. Pro získání kompletní sady vyberte vhodnou hlavovou a ruční sprchu. Přepínač zabudovaný v regulaci průtoku.



08149501

412,00

Extention

Prolunghe

Prodlužka

L=300 mm. (per ref / for Nr / Kód: 02416404, 190214, 20538501, 20019501, 190213, 20438704, 24219502, 00719501, 09049501, 90310, 90311, 90312, 90210, 90211, 90212, 90213, 90214, 87355, 87356)

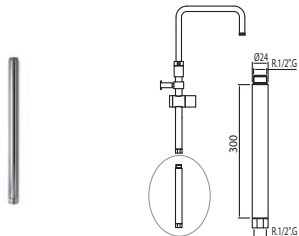

■ 918119503

108,00

Extention

Prolunghe

Prodlužka

L=650 mm. (per ref / for Nr / Kód: 02416404, 190214, 20538501, 20019501, 190213, 20438704, 24219502, 00719501, 09049501, 90310, 90311, 90312, 90210, 90211, 90212, 90213, 90214, 87355, 87356)

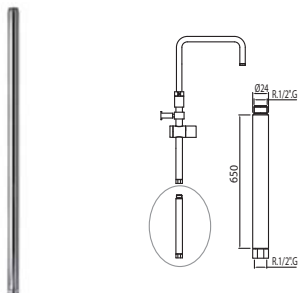

■ 18119502

142,00

Extention

Prolunghe

Prodlužka

L=300 mm. (per ref / for Nr / Kód: 01299501, 07099501, 081192, 08149501, 181191, 181386, 181385*, 20319101, 20438701, 08119301) ino al 05/2012 - until 05/2012 - do 05/2012

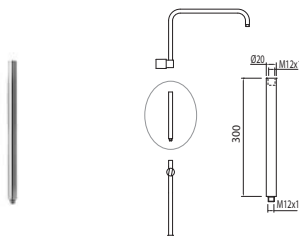

■ 918138503

90,95

■ M 918138503NM

150,00

■ M 918138503BM

150,00

■ 918138503AC

150,00

Extention

Prolunghe

Prodlužka

L=650 mm. (per ref / for Nr / Kód: 01299501, 07099501, 081192, 08149501, 181191, 181386, 181385*, 20319101, 20438701, 08119301) ino al 05/2012 - until 05/2012 - do 05/2012

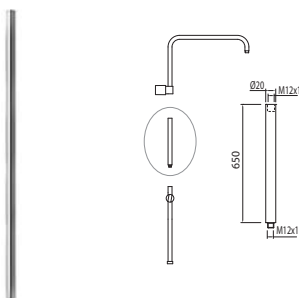

■ 18138506

102,00

■ M 18138506NM

169,00

■ M 18138506BM

169,00

■ 18138506AC

169,00

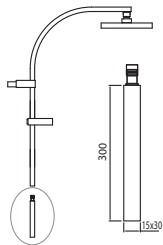

Extension

Prolunghe

Prodlužka

L=300 mm. (per ref / for Nr / Kód: 107395, 00719101, 20439501, 20539501)

910691403 **126,00**

M 910691403NM **208,00**

M 910691403BM **208,00**

910691403AC **208,00**

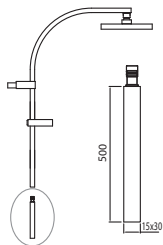

Extension

Prolunghe

Prodlužka

L=500 mm. (per ref / for Nr / Kód: 107395, 00719101, 20439501, 20539501)

10691405 **171,00**

M 10691405NM **282,00**

M 10691405BM **282,00**

10691405AC **282,00**

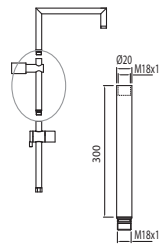

Extension

Prolunghe

Prodlužka

L=300 mm. (per ref / for Nr / Kód: 90481, 90583, 90281, 90393)

913446303 **90,95**

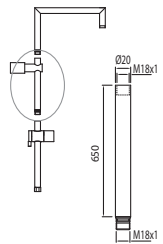

Extension

Prolunghe

Prodlužka

L=650 mm. (per ref / for Nr / Kód: 90481, 90583, 90281, 90393)

13446302 **102,00**

Extention

Prolungha

Prodlužka

L=300 mm. (per ref / for Nr / Kód: 90385, 61475, 181385**) ** dal 05/2012 - since 05/2012 - od 05/2012

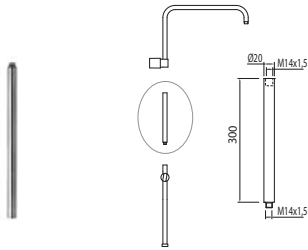

913419503

90,95

Extention

Prolungha

Prodlužka

L=650 mm. (per ref / for Nr / Kód: 90385, 61475, 181385**) ** dal 05/2012 - since 05/2012 - od 05/2012

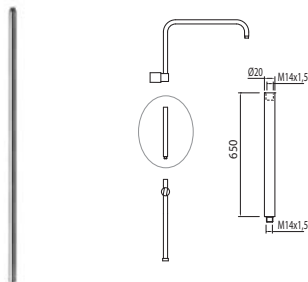

13419502

102,00

356 / Shower thermostatically-controlled sets | Gruppi doccia termostatici | Termostatická sprchová souprava



367 / Bath thermostatically-controlled sets | Gruppi vasca termostatici | Termostatická vanová souprava



368 / Thermostatically-controlled | Termostatica | Termostatické



376 / Thermostatically-controlled | Termostatiche | Termostatické (COMAPCT)



378 / Shower columns | Colonne doccia | Sprchové panely



THERMOSTATICALLY-CONTROLLED SETS
GRUPPI TERMOSTATICI
TERMOSTATICKÉ SOUPRAVY



www.qtrr.es/termostatic



Chrome
Cromato
Chrom



Anodized
Anodizzato
Anodizovaný

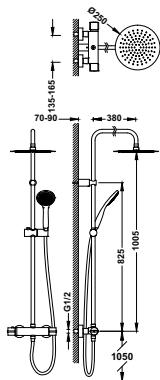

Wall thermostatic shower mixer

- Fixed shower head Ø 250 mm. with ball joint. Stainless material.
- Anti-limescale hand shower.
- Satin hose.
- Diverter integrated in the flow control.

Set doccia termostatica

- Doccia fissa Ø 250 mm. con snodo. Materiale acciaio inossidabile.
- Doccetta anticalcare.
- Tubo flessibile satin.
- Invertitore integrato nel regolatore di portata.

Souprava termostatické sprchové baterie

- Pevná sprcha Ø 250 mm. s kloubeM. Materiál nerezová ocel.
- Ruční sprcha, proti usaz. vod. Kamene.
- Flexi hadice SATIN.
- Přepínač zabudovaný v regulaci průtoku.



918116110

18138502

422,00

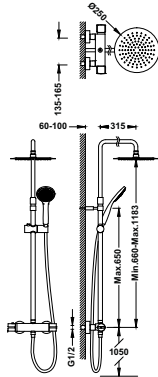

Wall thermostatic shower mixer

- Fixed shower head Ø 250 mm. with ball joint. Stainless material.
- Anti-limescale hand shower.
- Satin hose.
- Telescopic bar.
- Diverter integrated in the flow control.

Set doccia termostatica

- Doccia fissa Ø 250 mm. con snodo. Materiale acciaio inossidabile.
- Doccetta anticalcare.
- Flessibile satin.
- Asta telescopica.
- Invertitore integrato nel regolatore di portata.

Souprava termostatické sprchové baterie

- Pevná sprcha Ø 250 mm. s kloubelem. Materiál nerezová ocel.
- Ruční sprcha, proti usaz. vod. Kamene.
- Flexi hadice SATIN.
- Teleshopická tyč.
- Přepínač zabudovaný v regulaci průtoku.



19021402

481,00

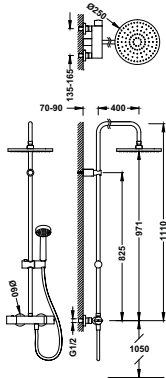

Wall thermostatic shower mixer

- Fixed shower head Ø 250 mm. with ball joint.
- Massage hand shower Ø 100 mm. (5 functions).
- Satin hose.
- Diverter integrated in the flow control.

Set doccia termostatica

- Doccia fissa Ø 250 mm. con snodo.
- Doccetta massaggio Ø 100 mm. (5 funzioni).
- Tubo flessibile satin.
- Invertitore integrato nel regolatore di portata.

Souprava termostatické sprchové baterie

- Pevná sprcha Ø 250 mm. s kloubelem.
- Ruční masážní sprcha Ø 100 mm. (5 funkcí).
- Flexi hadice SATIN.
- Přepínač zabudovaný v regulaci průtoku.



181385

436,00

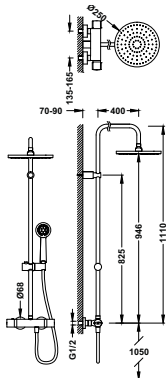

Wall thermostatic shower mixer

- Fixed shower head Ø 250 mm.
- Anti-limescale hand shower Ø 80 mm.
- Double interlocked shower hose.
- Diverter integrated in the flow control.

Set doccia termostatica

- Doccia fissa Ø 250 mm.
- Doccia mobile anticalcare Ø 80 mm.
- Flessibile doppia graffatura.
- Invertitore integrato nel regolatore di portata.

Souprava termostatické sprchové baterie

- Pevná sprcha Ø 250 mm.
- Ruční sprcha proti usazování vod. kamene Ø 80 mm.
- Flexi hadice s dvojitým zámkem.
- Přepínač zabudovaný v regulaci průtoku.

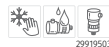

181386

415,00

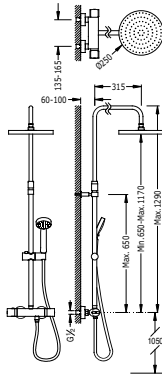

Wall thermostatic shower mixer

- Fixed shower head Ø 250 mm. with ball joint.
- Massage hand shower Ø 100 mm. (5 fonctions).
- Satin hose.
- Telescopic bar.
- Diverter integrated in the flow control.

Set doccia termostatica

- Doccia fissa Ø 250 mm. con snodo.
- Doccetta massaggio Ø 100 mm. (5 funzioni).
- Flessibile satin.
- Asta telescopica.
- Invertitore integrato nel regolatore di portata.

Souprava termostatické sprchové baterie

- Pevná sprcha Ø 250 mm. s kloubem.
- Ruční masážní sprcha Ø 100 mm. (5 funkcí).
- Flexi hadice SATIN.
- Teleshkopická tyč.
- Přepínač zabudovaný v regulaci průtoku.



918116110

190214

481,00

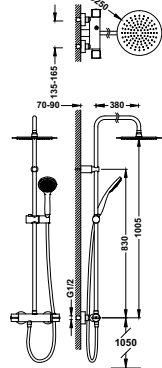

Wall thermostatic shower mixer

- Fixed shower head Ø 250 mm. with ball joint. Stainless material.
- Anti-limescale hand shower.
- Satin hose.
- Diverter integrated in the flow control.

Set doccia termostatica

- Doccia fissa Ø 250 mm. con snodo. Materiale acciaio inossidabile.
- Doccetta anticalcare.
- Flessibile satin.
- Invertitore integrato nel regolatore di portata.

Souprava termostatické sprchové baterie

- Pevná sprcha Ø 250 mm. s kloubem. Materiál nerezová ocel.
- Ruční sprcha, proti usaz. vod. Kamene.
- Flexi hadice SATIN.
- Přepínač zabudovaný v regulaci průtoku.



29919508

20438712

422,00

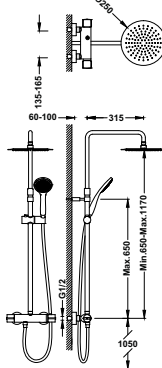

Wall thermostatic shower mixer

- Fixed shower head Ø 250 mm. with ball joint. Stainless material.
- Anti-limescale hand shower.
- Satin hose.
- Telescopic bar.
- Diverter integrated in the flow control.

Set doccia termostatica

- Doccia fissa Ø 250 mm. con snodo. Materiale acciaio inossidabile.
- Doccetta anticalcare.
- Flessibile satin.
- Asta telescopica.
- Invertitore integrato nel regolatore di portata.

Souprava termostatické sprchové baterie

- Pevná sprcha Ø 250 mm. s kloubem. Materiál nerezová ocel.
- Ruční sprcha, proti usaz. vod. Kamene.
- Flexi hadice SATIN.
- Teleshkopická tyč.
- Přepínač zabudovaný v regulaci průtoku.



29919508

20438713

467,00

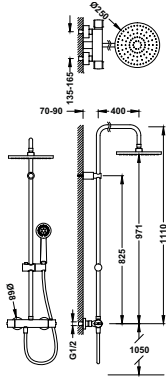

Wall thermostatic shower mixer

- Fixed shower head Ø 250 mm. with ball joint.
- Anti-limescale hand shower Ø 80 mm.
- Satin hose.
- Diverter integrated in the flow control.

Set doccia termostatica

- Doccia fissa Ø 250 mm. con snodo.
- Doccetta anticalcare Ø 80 mm.
- Flessibile satin.
- Invertitore integrato nel regolatore di portata.

Souprava termostatické sprchové baterie

- Pevná sprcha Ø 250 mm. s kĺubom.
- Ruční sprcha, proti usaz. vod. kamene Ø 80 mm.
- Flexi hadice SATIN.
- Prepínač zabudovaný v regulaci průtoku.



20438701

422,00

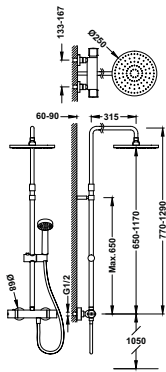

Wall thermostatic shower mixer

- Fixed shower head Ø 250 mm. with ball joint.
- Anti-limescale hand shower Ø 80 mm.
- Satin hose.
- Telescopic bar.
- Diverter integrated in the flow control.

Set doccia termostatica

- Doccia fissa Ø 250 mm. con snodo.
- Doccetta anticalcare Ø 80 mm.
- Flessibile satin.
- Asta telescopica.
- Invertitore integrato nel regolatore di portata.

Souprava termostatické sprchové baterie

- Pevná sprcha Ø 250 mm. s kĺubom.
- Ruční sprcha, proti usaz. vod. kamene Ø 80 mm.
- Flexi hadice SATIN.
- Teleskopická tyč.
- Prepínač zabudovaný v regulaci průtoku.



20438703

467,00

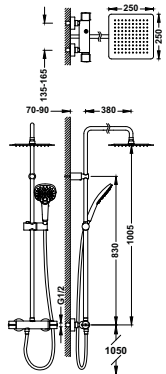

Wall thermostatic shower mixer

- Fixed shower head 250x250 mm. with ball joint. Stainless material.
- Anti-limescale hand shower (3 fonctions)
- Satin hose.
- Diverter integrated in the flow control.

Set doccia termostatica

- Doccia fissa 250x250 mm. con snodo. Materiale acciaio inossidabile.
- Doccetta anticalcare (3 funzioni).
- Tubo flessibile satin.
- Invertitore integrato nel regolatore di portata.

Souprava termostatické sprchové baterie

- Pevná sprcha 250x250 mm. s kĺubom. Materiál nerezová oceľ.
- Ruční sprcha (3 funkci) proti usaz. vod. kamene
- Flexi hadice SATIN.
- Prepínač zabudovaný v regulaci průtoku.



18138503

422,00

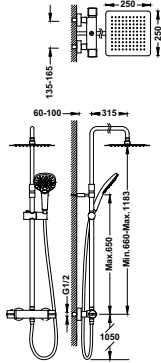

Wall thermostatic shower mixer

- Fixed shower head 250x250 mm. with ball joint. Stainless material.
- Anti-limescale hand shower (3 fonctions)
- Satin hose.
- Telescopic bar.
- Diverter integrated in the flow control.

Set doccia termostatica

- Doccia fissa 250x250 mm. con snodo. Materiale acciaio inossidabile.
- Doccetta anticalcare (3 funzioni).
- Flessibile satin.
- Asta telescopica.
- Invertitore integrato nel regolatore di portata.

Souprava termostatické sprchové baterie

- Pevná sprcha 250x250 mm. s kloboum. Materiál nerezová ocel.
- Ruční sprcha (3 funkce) proti usaz. vod. Kamene
- Flexi hadice SATIN.
- Teleskopická tyč.
- Přepínač zabudovaný v regulaci průtoku.



19021302

476,00

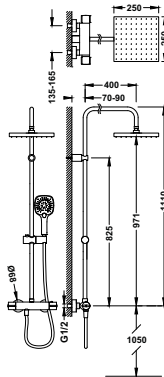

Wall thermostatic shower mixer

- Fixed shower head 250x250 mm. with ball joint.
- Anti-limescale hand shower 107x107 mm.
- Satin hose.
- Diverter integrated in the flow control.

Set doccia termostatica

- Doccia fissa 250x250 mm. con snodo.
- Doccetta anticalcare 107x107 mm.
- Flessibile satin.
- Invertitore integrato nel regolatore di portata.

Souprava termostatické sprchové baterie

- Pevná sprcha 250x250 mm. s kloboum.
- Ruční sprcha, proti usaz. vod. kamene 107x107 mm.
- Flexi hadice SATIN.
- Přepínač zabudovaný v regulaci průtoku.



20438708

422,00

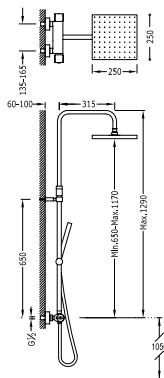

Wall thermostatic shower mixer

- Fixed shower head 250x250 mm. with ball joint.
- Anti-limescale hand shower.
- Satin hose.
- Telescopic bar.
- Diverter integrated in the flow control.

Set doccia termostatica

- Doccia fissa 250x250 mm. con snodo.
- Doccetta anticalcare.
- Flessibile satin.
- Asta telescopica.
- Invertitore integrato nel regolatore di portata.

Souprava termostatické sprchové baterie

- Pevná sprcha 250x250 mm. s kloboum.
- Ruční sprcha, proti usaz. vod. kamene.
- Flexi hadice SATIN.
- Teleskopická tyč.
- Přepínač zabudovaný v regulaci průtoku.



190213

476,00

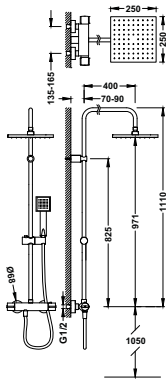

Wall thermostatic shower mixer

- Fixed shower head 250x250 mm. with ball joint.
- Anti-limescale hand shower 80x80 mm.
- Satin hose.
- Diverter integrated in the flow control.

Set doccia termostatica

- Doccia fissa 250x250 mm. con snodo.
- Doccetta anticalcare 80x80 mm.
- Flessibile satin.
- Invertitore integrato nel regolatore di portata.

Souprava termostatické sprchové baterie

- Pevná sprcha 250x250 mm. s kloboum.
- Ruční sprcha, proti usaz. vod. kamene 80x80 mm.
- Flexi hadice SATIN.
- Přepínač zabudovaný v regulaci průtoku.



20438702

422,00

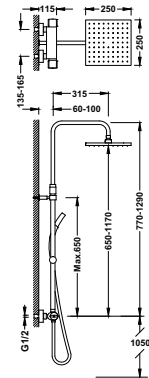

Wall thermostatic shower mixer

- Fixed shower head 250x250 mm. with ball joint.
- Anti-limescale hand shower 80x80 mm.
- Satin hose.
- Telescopic bar.
- Diverter integrated in the flow control.

Set doccia termostatica

- Doccia fissa 250x250 mm. con snodo.
- Doccetta anticalcare 80x80 mm.
- Flessibile satin.
- Asta telescopica.
- Invertitore integrato nel regolatore di portata.

Souprava termostatické sprchové baterie

- Pevná sprcha 250x250 mm. s kloboum.
- Ruční sprcha, proti usaz. vod. kamene 80x80 mm.
- Flexi hadice SATIN.
- Teleskopická tyč.
- Přepínač zabudovaný v regulaci průtoku.



20438704

467,00

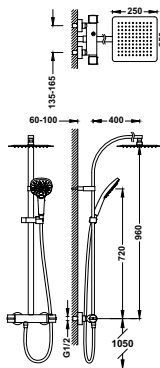

Wall thermostatic shower mixer

- Fixed shower head 250x250 mm. with ball joint. Stainless material.
- Anti-limescale hand shower (3 fonctions)
- Satin hose.
- Diverter integrated in the flow control.

Set doccia termostatica

- Doccia fissa 250x250 mm. con snodo. Materiale acciaio inossidabile.
- Doccetta anticalcare (3 funzioni).
- Flessibile satin.
- Invertitore integrato nel regolatore di portata.

Souprava termostatické sprchové baterie

- Pevná sprcha 250x250 mm. s kloboum. Materiál nerezová ocel.
- Ruční sprcha (3 funkce) proti usaz. vod. kamene
- Flexi hadice SATIN.
- Přepínač zabudovaný v regulaci průtoku.



20439503

514,00

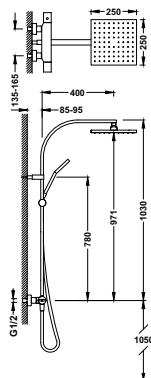

Wall thermostatic shower mixer

- Fixed shower head 250x250 mm. with ball joint.
- Anti-limescale hand shower 80x80 mm.
- Satin hose.
- Diverter integrated in the flow control.

Set doccia termostatica

- Doccia fissa 250x250 mm. con snodo.
- Doccetta anticalcare 80x80 mm.
- Flessibile satin.
- Invertitore integrato nel regolatore di portata.

Souprava termostatické sprchové baterie

- Pevná sprcha 250x250 mm. s kloubem.
- Ruční sprcha, proti usaz. vod. kamene 80x80 mm.
- Flexi hadice SATIN.
- Přepínač zabudovaný v regulaci průtoku.



20439501

514,00

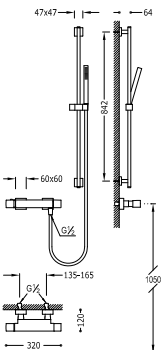

Wall thermostatic shower mixer

- Sliding bar long. 842 mm.
- Anti-limescale hand shower.
- Satin hose.

Kit doccia termostatica

- Asta anticivolo lungo 842 mm.
- Doccetta anticalcare.
- Flessibile satin.

Sprchová sada s termostatickou baterií

- Posuvná tyč 842 mm.
- Ruční sprcha, proti usaz. vod. kamene.
- Flexi hadice SATIN.



00716402

481,00

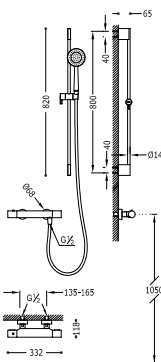

Wall thermostatic shower mixer

- Sliding bar long. 800 mm.
- Anti-limescale hand shower.
- Satin hose.

Kit doccia termostatica

- Asta anticivolo lungo 800 mm.
- Doccetta anticalcare.
- Flessibile satin.

Sprchová sada s termostatickou baterií

- Posuvná tyč 800 mm.
- Ruční sprcha, proti usaz. vod. kamene.
- Flexi hadice SATIN.



06216402

331,00

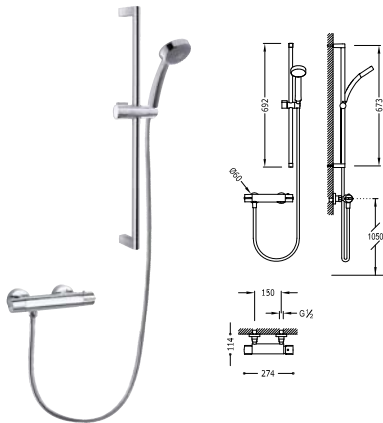

Wall thermostatic shower mixer

- Sliding bar Ø 20,6 mm, long. 673 mm.
- Anti-limescale hand shower Ø 80 mm.
- Double interlocked shower hose.

Kit doccia termostatica

- Asta anticivolo Ø 20,6 mm, lungo 673 mm.
- Doccetta anticalcare Ø 80 mm.
- Flessibile doppia graffatura.

Sprchová sada s termostatickou baterií

- Posuvná tyč Ø 20,6 mm, délka 673 mm.
- Ruční sprcha, proti usaz. vod. kamene Ø 80 mm.
- Flexi hadice s dvojitým zámekem.



20419602

194,00

Buy your box
Acquista il tuo box
Objednejte si svůj box

SELF-SERVICE BOXES / Shower items, thermostatic sets, mixer taps and shower hoses, ideal for your point of sale.

CASSE SELF-SERVICE / Articoli per doccia, set termostatici, miscelatori monocomando o flessibili, ideali per il punto vendita

SAMOOBSLUŽNÉ POKLADNY / Výrobky do sprchy, termostatické sady, jednopákové baterie, kovové hadice, ideální výbava prodejního místa.



www.qrtr.es/promo-box



Wall thermostatic shower mixer

- Massage hand shower.
- Sliding bar PRACTIC-MAX.
- Thermostatic shower.

Kit doccia termostatica

- Doccetta massaggio.
- Asta anticivolo PRACTIC-MAX.
- Vasca termostatica.

Sprchová sada s termostatickou baterií

- Ruční masážní sprcha.
- Posuvná tyč PRACTIC-MAX.
- Termostatická sprchová baterie.



183395

257,00

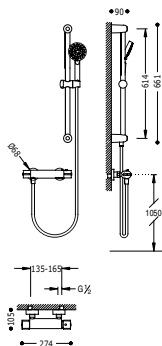

Wall thermostatic shower mixer

- Sliding bar ECO (Ø 25 mm, long. 600 mm).
- Massage hand shower Ø 100 mm (5 positions).
- Satin hose.

Kit doccia termostatica

- Asta anticivolo ECO (Ø 25 mm, lungo 600 mm).
- Doccetta massaggio Ø 100 mm. (5 funzioni).
- Flessibile satin.

Sprchová sada s termostatickou baterií

- Posuvná tyč ECO (Ø 25 mm, délka 600 mm).
- Ruční masážní sprcha Ø 100 mm. (5 funkci).
- Flexi hadice SATIN.



09018602

230,00

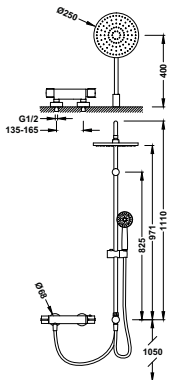

Wall thermostatic shower mixer

- Fixed shower head Ø 250 mm. with ball joint.
- Anti-limescale hand shower Ø 80 mm.
- Satin hose.

Set doccia termostatica

- Doccia fissa Ø 250 mm. con snodo.
- Doccetta anticalcare Ø 80 mm.
- Flessibile satin.

Souprava termostatické sprchové baterie

- Pevná sprcha Ø 250 mm. s kloubem.
- Ruční sprcha, proti usaz. vod. kamene Ø 80 mm.
- Flexi hadice SATIN.



20438501

293,00

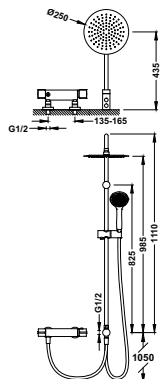

Wall thermostatic shower mixer

- Fixed shower head Ø 250 mm. with ball joint. Stainless material.
- Anti-limescale hand shower Ø 80 mm.
- Satin hose.

Set doccia termostatica

- Doccia fissa Ø 250 mm. con snodo. Materiale acciaio inossidabile.
- Doccetta anticalcare.
- Flessibile satin.

Souprava termostatické sprchové baterie

- Pevná sprcha Ø 250 mm. s kloubem. Materiál nerezová ocel.
- Ruční sprcha, proti usaz. vod. kamene.
- Flexi hadice SATIN.



20438503

293,00

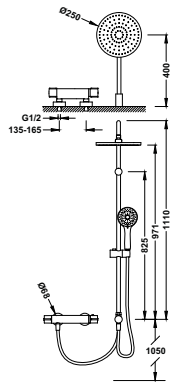

Wall thermostatic shower mixer

- Fixed shower head Ø 250 mm. with ball joint.
- Massage hand shower Ø 100 mm. (5 fonctions).
- Satin hose.

Set doccia termostatica

- Doccia fissa Ø 250 mm. con snodo.
- Doccetta massaggio Ø 100 mm. (5 funzioni).
- Flessibile satin.

Souprava termostatické sprchové baterie

- Pevná sprcha Ø 250 mm. s kloubem.
- Ruční masážní sprcha Ø 100 mm. (5 funkcí).
- Flexi hadice SATIN.



190385

326,00

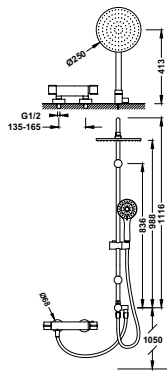

Wall thermostatic shower mixer

- Sliding bar in their wall holder.
- Fixed shower head \varnothing 250 mm. with ball joint.
- Massage hand shower \varnothing 100 mm. (5 fonctions).
- Satin hose.

Set doccia termostatica

- Barra e supporti parete regolabili.
- Doccia fissa \varnothing 250 mm. con snodo.
- Doccetta massaggio \varnothing 100 mm. (5 funzioni).
- Flessibile satin.

Souprava sprchové termostatické baterie

- Posuvná tyč na nástěnných držácích.
- Pevná sprcha \varnothing 250 mm. s kloubem.
- Ruční masážní sprcha \varnothing 100 mm. (5 funkcí).
- Flexi hadice SATIN.



190387

350,00

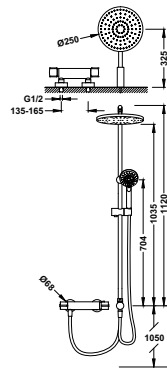

Wall thermostatic shower mixer

- Fixed shower head \varnothing 250 mm. with ball joint.
- Massage hand shower \varnothing 100 mm. (5 fonctions).
- Satin hose.

Set doccia termostatica

- Doccia fissa \varnothing 250 mm. con snodo.
- Doccetta massaggio \varnothing 100 mm. (5 funzioni).
- Flessibile satin.

Souprava termostatické sprchové baterie

- Pevná sprcha \varnothing 250 mm. s kloubem.
- Ruční masážní sprcha \varnothing 100 mm. (5 funkcí).
- Flexi hadice SATIN.



190388

328,00

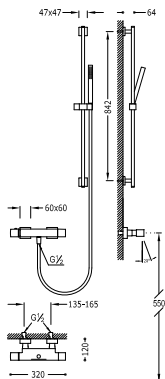

Thermostatic bathtub

- Sliding bar long. 842 mm.
- Anti-limescale hand shower.
- Satin hose.
- Diverter integrated in the flow control.

Kit vasca termostatica

- Asta antiscivolo lungo 842 mm.
- Doccetta anticalcare.
- Flessibile satin.
- Invertitore integrato nel regolatore di portata.

Termostatický vanová set

- Posuvná tyč 842 mm.
- Ruční sprcha, proti usaz. vod. kamene.
- Flexi hadice SATIN.
- Přepínač zabudovaný v regulaci průtoku.



910616110

06217402

402,00

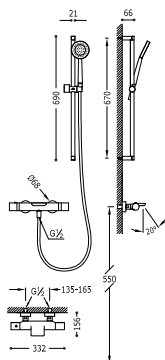

Thermostatic bathtub

- Sliding bar Ø 20,6 mm. long. 673 mm.
- Anti-limescale hand shower.
- Satin hose.
- Diverter integrated in the flow control.

Kit vasca termostatica

- Asta antiscivolo Ø 20,6 mm. lungo 673 mm.
- Doccetta anticalcare.
- Flessibile satin.
- Invertitore integrato nel regolatore di portata.

Termostatický vanová set

- Posuvná tyč Ø 20,6 mm, délka 673 mm.
- Ruční sprcha, proti usaz. vod. kamene.
- Flexi hadice SATIN.
- Přepínač zabudovaný v regulaci průtoku.



29919503

06217402

347,00

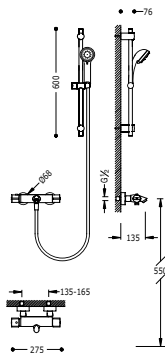

Thermostatic bathtub

- Sliding bar long. 516 mm.
- Massage shower, 3 positions.
- Diverter integrated in the flow control.

Kit vasca termostatica

- Asta antiscivolo lungo 516 mm.
- Doccetta massaggio, 3 posizioni.
- Invertitore integrato nel regolatore di portata.

Termostatický vanová set

- Posuvná tyč 516 mm.
- Masážní sprcha, 3 polohy.
- Přepínač zabudovaný v regulaci průtoku.



919A16110

183398

317,00

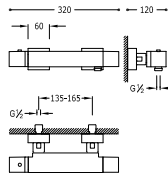

Wall thermostatic shower mixer

Doccia termostatica
Termostatická sprchová baterie



107164

304,00

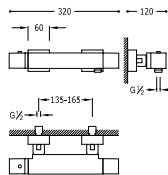

Wall thermostatic shower mixer

(Anti-limescale hand shower with directable support. Shower hose satin.)

Doccia termostatica
(Doccetta anticalcare con supporto orientabile. Flesso satinato.)

Termostatická sprchová baterie
(Ruční sprcha s nastavitelným držákem, proti usaz. vod. kamene. Flexi hadice SATIN (9134.609.15))



1071649

340,00

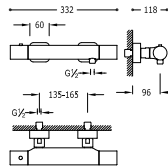

Wall thermostatic shower mixer

Doccia termostatica
Termostatická sprchová baterie



20016401

219,00

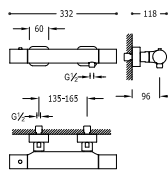

Wall thermostatic shower mixer

(Anti-limescale hand shower with directable support. Shower hose satin.)

Doccia termostatica
(Doccetta anticalcare con supporto orientabile. Flessibile satin.)

Termostatická sprchová baterie
(Ruční sprcha s nastavitelným držákem, proti usaz. vod. kamene s flexi hadice SATIN.)



20016409

268,00

Wall thermostatic shower mixer

Doccia termostatica

Termostatická sprchová baterie

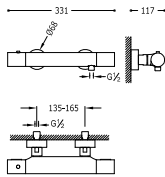

06116201

219,00

Wall thermostatic shower mixer

(Anti-limescale hand shower with directable support and satin hose).

Doccia termostatica

(Doccetta anticalcare con supporto orientabile. Flessibile satin).

Termostatická sprchová baterie

(Ruční sprcha s nastavitelným držákem, proti usaz. vod. kamene a flexi hadice SATIN).

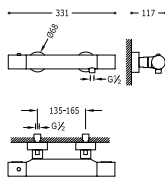

06116209

268,00

Wall thermostatic shower mixer

(Anti-limescale hand shower with directable support. Shower hose satin).

Doccia termostatica

(Doccetta anticalcare con supporto orientabile. Flessibile satin).

Termostatická sprchová baterie

(Ruční sprcha s nastavitelným držákem, proti usaz. vod. kamene a flexi hadice SATIN).

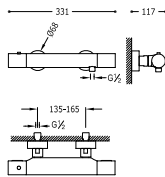

205164019

249,00

Wall thermostatic shower mixer

Doccia termostatica

Termostatická sprchová baterie

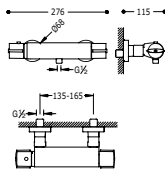

181164

174,00

Wall thermostatic shower mixer

(Massage hand shower Ø 100 mm. (5 fonctions) with directable support and satin hose).

Doccia termostatica

(Doccetta Ø 100 mm. (5 funzioni) con supporto orientabile e flessibile satin).

Termostatická sprchová baterie

(Ruční masážní sprcha Ø 100 mm. (5 funkci) s nastavitelným držákem. Flexi hadice SATIN).

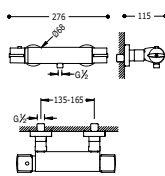

1811649

223,00

Wall thermostatic shower mixer

Doccia termostatica

Termostatická sprchová baterie

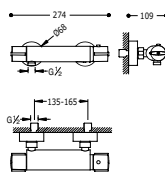

190186

145,00

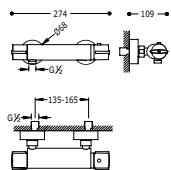

Wall thermostatic shower mixer
(Anti-limescale hand shower with directable support. Shower hose satin).

Doccia termostatica
(Doccetta anticalcare con supporto orientabile. Flessibile satin).

Termostatická sprchová baterie
(Ruční sprcha s nastavitelným držákem, proti usaz. vod. kamene a flexi hadice SATIN).



09018601

170,00

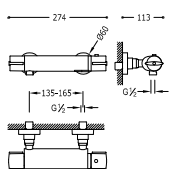

Wall thermostatic shower mixer

Doccia termostatica

Termostatická sprchová baterie



20419601

135,00

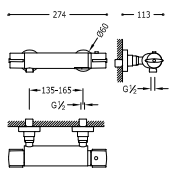

Wall thermostatic shower mixer
(Anti-limescale hand shower with directable support. Double interlocked shower hose).

Doccia termostatica
(Doccetta anticalcare con supporto orientabile. Flessibile doppia graffatura).

Termostatická sprchová baterie
(Ruční sprcha s nastavitelným držákem, proti usaz. vod. kamene a flexi hadice s dvojm. zámkem).



20419603

156,00

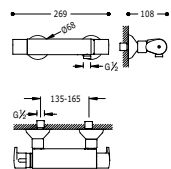

Wall thermostatic shower mixer

Doccia termostatica

Termostatická sprchová baterie



190162

180,00

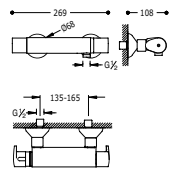

Wall thermostatic shower mixer
(Anti-limescale hand shower with directable support. Shower hose satin).

Doccia termostatica
(Doccetta anticalcare con supporto orientabile. Flessibile satin).

Termostatická sprchová baterie
(Ruční sprcha s nastavitelným držákem, proti usaz. vod. kamene a flexi hadice SATIN).



1901629

226,00

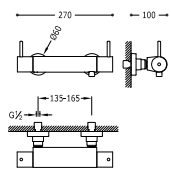

Wall thermostatic shower mixer
Suitable for persons with physical disabilities.

Doccia termostatica
Indicato per persone con disabilità fisiche

Termostatická sprchová baterie
Určeno pro osoby s fyzickým handicapem



09026401

198,00

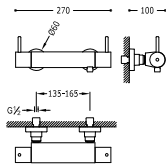

Wall thermostatic shower mixer with cascade
 Anti-limescale hand shower with directable support. Shower hose satin. Suitable for persons with physical disabilities.

Doccia termostatica
 Doccetta anticalcare con supporto orientabile. Flessibile satin. Indicato per persone con disabilità fisiche

Termostatická sprchová baterie
 Ruční sprcha s nastavitelným držákem (299.631.03), proti usaz. vod. kamene a flexi hadice SATIN. Určeno pro osoby s fyzickým handicapem



09096401

230,00

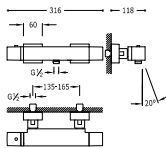

Wall thermostatic bath and shower mixer with cascade
 Diverter integrated in the flow control.

Vasca-Doccia termostatica
 con cascata. Invertitore integrato nel regolatore di portata.

Termostatická baterie pro vanu-sprchu
 s kaskádou. Přepínač zabudovaný v regulaci průtoku.



107174

357,00

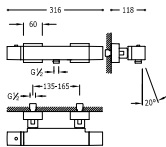

Wall thermostatic bath and shower mixer with cascade (Anti-limescale hand shower with directable support)
 Shower hose satin. Diverter integrated in the flow control.

Vasca-Doccia termostatica
 Con bocca a cascata (Doccetta anticalcare con supporto orientabile. Flessibile satinato). Invertitore integrato nel regolatore di portata.

Termostatická baterie pro vanu-sprchu
 s kaskádou (Ruční sprcha s nastavitelným držákem, proti usaz. vod. kamene. Flexi hadice SATIN). Přepínač zabudovaný v regulaci průtoku.



1071749

404,00

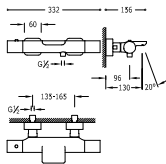

Vasca-Doccia termostatica
 con cascata. Invertitore integrato nel regolatore di portata.

Wall thermostatic shower mixer with cascade
 Diverter integrated in the flow control.

Termostatická baterie pro vanu-sprchu
 s kaskádou. Přepínač zabudovaný v regulaci průtoku.



20017401

280,00

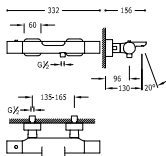

Wall thermostatic bath and shower mixer with cascade (Anti-limescale hand shower with directable support)
 Shower hose satin. Diverter integrated in the flow control.

Bagno doccia termostatica
 Con bocca a cascata (Doccetta anticalcare con supporto orientabile. Flessibile satin). Invertitore integrato nel regolatore di portata.

Termostatická baterie pro vanu-sprchu
 s kaskádou (Ruční sprcha s nastavitelným držákem, proti usaz. vod. kamene a flexi hadice SATIN). Přepínač zabudovaný v regulaci průtoku.



20017409

337,00

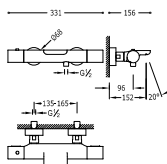

Wall thermostatic shower mixer with cascade. Diverter integrated in the flow control.

Vasca-Doccia termostatica con cascata. Invertitore integrato nel regolatore di portata.

Termostatická baterie pro vanu-sprchu s kaskádou. Přepínač zabudovaný v regulaci průtoku.



06117201

280,00

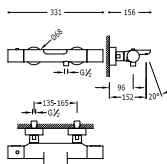

Wall thermostatic shower mixer with cascade (Anti-limescale hand shower with directable support. Shower hose satin). Diverter integrated in the flow control.

Vasca-Doccia termostatica Con bocca a cascata (Doccetta anticalcare con supporto orientabile. Flessibile satin). Invertitore integrato nel regolatore di portata.

Termostatická baterie pro vanu-sprchu s kaskádou (Ruční sprcha s nastavitelným držákem, proti usaz. vod. kamene a flexi hadice SATIN). Přepínač zabudovaný v regulaci průtoku.



06117209

329,00

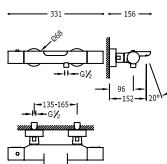

Wall thermostatic bath and shower mixer with cascade (Anti-limescale hand shower with directable support. Shower hose satin). Diverter integrated in the flow control.

Vasca-Doccia termostatica Con bocca a cascata (Doccetta anticalcare con supporto orientabile. Flessibile satin). Invertitore integrato nel regolatore di portata.

Termostatická baterie pro vanu-sprchu s kaskádou (Ruční sprcha s nastavitelným držákem, proti usaz. vod. kamene a flexi hadice SATIN). Přepínač zabudovaný v regulaci průtoku.



205174019

308,00

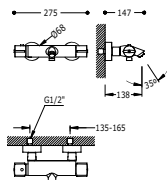

Badthermostaat Diverter integrated in the flow control.

Vasca-Doccia termostatica Invertitore integrato nel regolatore di portata.

Termostatická baterie pro vanu-sprchu Přepínač zabudovaný v regulaci průtoku.



181174

231,00

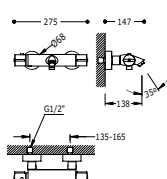

Badthermostaat (Massage hand shower Ø 100 mm. (5 fonctions)with directable support. Shower hose satin). Diverter integrated in the flow control.

Vasca-Doccia termostatica (Doccetta Ø 100 mm. (5 funzioni)con supporto orientabile. Flessibile satin). Invertitore integrato nel regolatore di portata.

Termostatická baterie pro vanu-sprchu (Ruční masážní sprcha Ø 100 mm. (5 funkce)s nastavitelným držákem, proti usaz. vod. kamene. Flexi hadice SATIN). Přepínač zabudovaný v regulaci průtoku.



1811749

276,00

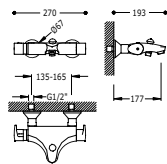

Wall thermostatic bath and shower mixer Vasca-Doccia termostatica

Termostatická baterie pro vanu-sprchu



190172

224,00

Wall thermostatic bath and shower mixer

(Anti-limescale hand shower with directable support. Shower hose satin.)

Vasca-Doccia termostatica
(Doccetta anticalcare con supporto orientabile. Flessibile satin.)

Termostatická baterie pro vanu-sprchu
(Ruční sprcha s nastavitelným držákem, proti usaz. vod. kamene a flexi hadice SATIN.)



1901729

270,00

Wall thermostatic shower mixer

Suitable for persons with physical disabilities. Diverter integrated in the flow control.

Vasca-Doccia termostatica
Indicato per persone con disabilità fisiche. Invertitore integrato nel regolatore di portata.

Termostatická baterie pro vanu-sprchu
Určeno pro osoby s fyzickým handicapem. Přepínač zabudovaný v regulaci průtoku.



09027401

250,00

Wall thermostatic shower mixer

Anti-limescale hand shower with directable support. Shower hose satin. Suitable for persons with physical disabilities. Diverter integrated in the flow control.

Vasca-Doccia termostatica
Doccetta anticalcare con supporto orientabile. Flessibile satin. Indicato per persone con disabilità fisiche. Invertitore integrato nel regolatore di portata.

Termostatická baterie pro vanu-sprchu
Ruční sprcha s nastavitelným držákem, proti usaz. vod. kamene a flexi hadice SATIN.). Určeno pro osoby s fyzickým handicapem. Přepínač zabudovaný v regulaci průtoku.



09097401

284,00

Shower-bath elbow adaptor

2 units with silencer

Gomito adattatore bagno-doccia
2 unità con silenziatore

Rohový ventil vana-sprcha
2 kusy s tlumičem

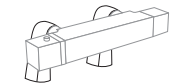
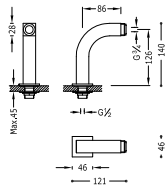

29987002

110,00

Shower-bath elbow adaptor

2 units with silencer

Gomito adattatore bagno-doccia
2 unità con silenziatore

Rohový ventil vana-sprcha
2 kusy s tlumičem

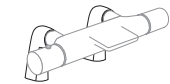
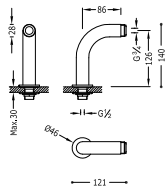

29987001

97,70





Compact design

Design compatto

Kompaktní konstrukce

The advantages of concealed thermostatic tapware, in the minimum space. The Compact thermostatic equipment by TRES is optimum both for plasterboard and solid wall constructions. All that is needed is 50 mm depth, at most, to embed the product in the wall. There are no screws in sight, reinforcing its pure, clean lines. With a safety button that limits the temperature to 38°C, and an inverter to regulate the water outlet.

I vantaggi di una rubinetteria termostatica a incasso in uno spazio ridotto. I rubinetti termostatici Compact di TRES sono l'ideale da montare su pareti sia in cartongesso sia in muratura. È necessario soltanto un massimo di 50 mm di profondità per incassare il prodotto nel muro. Viti non visibili e linee essenziali e semplici. Con pulsante di sicurezza che riduce la temperatura a 38°C e inverter per azionare l'uscita dell'acqua.

Výhody podomítkově termostatické baterie s minimálními požadavky na prostor. Termostatické baterie Compact od TRES představují optimální řešení pro montáž do sádkokartonu i do zděných stěn. Potřebná hloubka k vestavění produktu je maximálně 50 mm. Nepřítomnost viditelných hlav šroubů znovu umocňuje minimalistickou čistotu linií. Bezpečnostní tlačítko se stará o omezení maximální teploty na 38°C, k nastavení výstupu vody jsou produkty vybaveny měničem.

THERMOSTATICALLY-CONTROLLED SETS | GRUPPI TERMOSTATICI | TERMOSTATICKÉ SOUPRAVY (COMPACT)

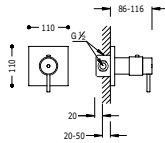

Concealed thermostatic mixer. Single lever shower mixer with water shut off and flow control.
 · Built-in body included

Termostatica ad incasso doccia
 Con chiusura e regolazione di portata
 · Corpo incassato incluso

Termostatická sprchová baterie podomítková s uzávěrem a regulací průtoku
 · Včetně podomítkového tělesa



190647

263,00

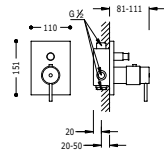

Concealed thermostatic mixer. Single lever bath and shower mixer with water shut off and flow control.
 · Built-in body included

Termostatica ad incasso vasca
 Con chiusura e regolazione di portata
 · Corpo incassato incluso

Termostatická baterie pro vanu-sprchu podomítková s uzávěrem a regulací průtoku
 · Včetně podomítkového tělesa



190652

360,00

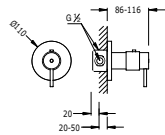

Concealed thermostatic mixer. Single lever shower mixer with water shut off and flow control.
 · Built-in body included

Termostatica ad incasso doccia
 Con chiusura e regolazione di portata
 · Corpo incassato incluso

Termostatická sprchová baterie podomítková s uzávěrem a regulací průtoku
 · Včetně podomítkového tělesa



190547

249,00

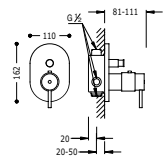

Concealed thermostatic mixer. Single lever bath and shower mixer with water shut off and flow control.
 · Built-in body included

Termostatica ad incasso vasca
 Con chiusura e regolazione di portata
 · Corpo incassato incluso

Termostatická baterie pro vanu-sprchu podomítková s uzávěrem a regulací průtoku
 · Včetně podomítkového tělesa



190552

346,00

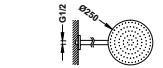

Concealed thermostatic shower kit with water shut off and flow control (2 ways).

- Built-in body included
- Fixed shower head Ø 250 mm. with ball joint.
- Elbow wall.
- Anti-limescale hand shower.
- Satin hose.

Kit termostatico doccia ad incasso con chiusura e regolazione di portata (2 vie).

- Corpo incassato incluso
- Doccia fissa Ø 250 mm. con snodo.
- Supporto per doccia.
- Doccetta anticalcare.
- Flessibile satin.

Podomítkový sprchový set termostatické bateri s uzávěrem a regulací průtoku (2-cestná).

- Včetně podomítkového tělesa
- Pevná sprcha Ø 250 mm. s kloubem.
- Držák s nástěnným přívodem vody.
- Ruční sprcha, proti usaz. vod. kamene.
- Flexi hadice SATIN.

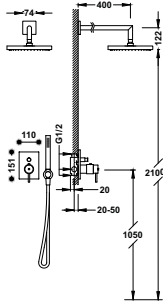

09096020

560,00

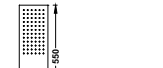

Concealed thermostatic shower kit with water shut off and flow control (2 ways).

- Built-in body included
- Stainless steel wall shower 160x550 mm.
- Elbow wall.
- Anti-limescale hand shower.
- Satin hose.

Kit termostatico doccia ad incasso con chiusura e regolazione di portata (2 vie).

- Corpo incassato incluso
- Doccia acciaio inossidabile da parete 160x550 mm.
- Supporto per doccia.
- Doccetta anticalcare.
- Flessibile satin.

Podomítkový sprchový set termostatické bateri s uzávěrem a regulací průtoku (2-cestná).

- Včetně podomítkového tělesa
- Nástěnné sprchové křepítko z nerez. oceli 160x550 mm.
- Držák s nástěnným přívodem vody.
- Ruční sprcha, proti usaz. vod. kamene.
- Flexi hadice SATIN.

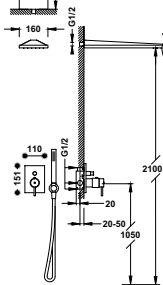

09096021

756,00

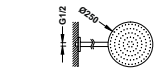

Concealed thermostatic shower kit with water shut off and flow control (2 ways).

- Built-in body included
- Fixed shower head Ø 250 mm. with ball joint.
- Elbow wall.
- Anti-limescale hand shower.
- Satin hose.

Kit termostatico doccia ad incasso con chiusura e regolazione di portata (2 vie).

- Corpo incassato incluso
- Doccia fissa Ø 250 mm. con snodo.
- Supporto per doccia.
- Doccetta anticalcare.
- Flessibile satin.

Podomítkový sprchový set termostatické bateri s uzávěrem a regulací průtoku (2-cestná).

- Včetně podomítkového tělesa
- Pevná sprcha Ø 250 mm. s kloubem.
- Držák s nástěnným přívodem vody.
- Ruční sprcha, proti usaz. vod. kamene.
- Flexi hadice SATIN.

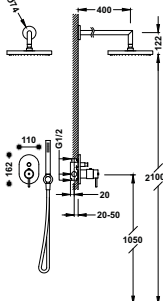

09096022

549,00



Shower columns

Colonne doccia

Sprchové panely





Large shower head

Enjoy a shower that will envelope and stimulate you with the delightful feeling of rain.

Soffione di grande formato

Per una doccia che ti avvolge e ti stimola con una piacevole sensazione di pioggia.

Velkoformátové sprchy

Získejte sprchu, která vás ovine a vzpruží při příjemném pocitu deště.



Anodised aluminium control panel

Di facile pulizia e massima resistenza alla corrosione e all'usura. Non richiede manutenzione.

Pannello di alluminio anodizzato

Di facile pulizia e massima resistenza alla corrosione e all'usura. Non richiede manutenzione.

Panel z anodizovaného hliníku

Snadně čištění a maximální odolnost proti korozi a opotřebení. Nepotřebuje údržbu.



Hand shower with different functions

Increase the invigorating and revitalising power of a water massage, combining the different jets.

Doccia a mano con funzioni

Aumenta il potere tonificante e rivitalizzante del massaggio ad acqua combinando i diversi getti.

Ruční sprcha s různými funkcemi

Zvyšuje tonifikační a revitalizační sílu vodní masáže kombinací různých proudů.



Simultaneous functions

Independent controls for each function, with a thermostatic cartridge that reacts instantly.

Funzioni simultanee

Comandi indipendenti per ogni funzione con cartuccia termostatica a risposta immediata.

Současné funkce

Samostatně ovládání každé funkce pomocí termostatického ventilu s okamžitou reakcí.



Adjustable jets

For a relaxing neck, back and lumbar massage.

Bocchette orientabili

Per un rilassante massaggio cervicale, dorsale e lombare.

Nastavitelné trysky

Pro relaxační masáž šíje, zad a beder.



Shower or bathtub installation

Ideal for filling bathtubs, graduating temperature or cooling feet.

Montaggio in doccia o vasca da bagno

Ideale per riempire vasche da bagno, regolare la temperatura, rinfrescare i piedi...

Souprava pro sprchu či vanu

Ideální k plnění van, graduace teploty vody, osvěžení nohou...

SHOWER COLUMNS | COLONNE DOCCIA | SPRCHOVÉ PANELE

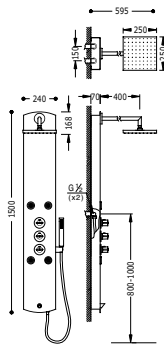

Thermostatic shower column LEX-B

- Fixed shower head 250x250 mm. with ball joint.
- Anti-limescale hand shower.
- Satin hose.

Colonna doccia termostatica LEX-B

- Doccia fissa 250x250 mm. con snodo.
- Doccetta anticalcare.
- Flessibile satin.

Termostatický vanový panel LEX-B

- Hlavová sprcha 250x250 mm. s kloubem.
- Ruční sprcha, proti usaz. vod. Kamene.
- Hadice satin.



AN 193124

903,00

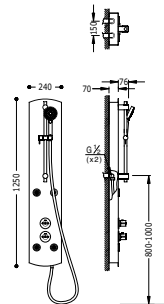

Thermostatic shower column LEX-D

- Massage hand shower.
- Satin hose.

Colonna di vasca termostatica LEX-D

- Doccetta massaggi.
- Flessibile satin.

Termostatický vanový panel LEX-D

- Masážní ruční sprcha.
- Hadice satin.



AN 193223

572,00

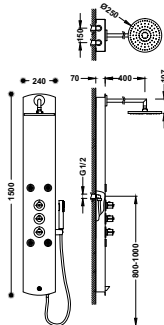

Thermostatic shower column LEX-B

- Fixed shower head Ø 250 mm. with ball joint.
- Anti-limescale hand shower.
- Satin hose.

Colonna doccia termostatica LEX-B

- Doccia fissa Ø 250 mm. con snodo.
- Doccetta anticalcare.
- Flessibile satin.

Termostatický vanový panel LEX-B

- Hlavová sprcha Ø 250 mm. s kloubem.
- Sprchová koncovka, proti usaz. vod. Kamene.
- Hadice satin.



AN 193123

828,00

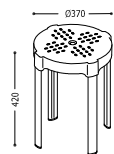

Bathroom stool
Max. supported weight 225 kg

Sgabello da bagno
Peso massimo supportato 225 kg.

Koupelnová stolička
Maximální nosnost 225 kg.



03463628

65,85



Adjustable bathroom stool
Max. supported weight 225 kg

Sgabello da bagno regolabile
Peso massimo supportato 225 kg.

Nastavitelná koupelnová stolička
Maximální nosnost 225 kg.



03463629

83,70

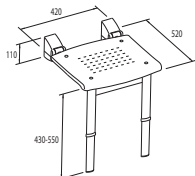

Foldable shower chair with legs
Sedile da doccia piegabile con gambe

Skládací sprchová židle



03463630

239,00

384 / **Bathtub mixer taps | Monocomando esterno | mechanismus vany**



390 / **Built-in sets | Monocomando ad incasso | Vestavěné soupravy**



407 / **Deck-mounted bathtubs | Bordovasca | Vany s prodlouženým pultem**



TRÉS

**MIXER TAPS
MONOCOMANDI
BATERIE**



www.qtr.es/mono



Chrome
Cromato
Chrom



MONOCOMANDI BAGNO / BATHTUB MIXER TAPS / JEDNOPÁKOVÝ MECHANISMUS VANY

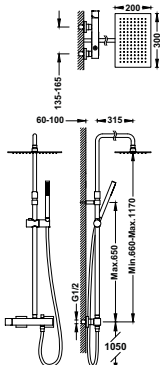

Bar-shower set

- Fixed shower head 300x200 mm. with ball joint. Stainless material.
- Anti-limescale hand shower.
- Satin hose.
- Telescopic bar.

Set doccia

- Doccia fissa 300x200 mm. con snodo. Materiale acciaio inossidabile.
- Doccetta anticalcare.
- Flessibile satin.
- Asta telescopica.

Sprchová souprava, proti usaz. vod. kamene

- Pevná sprcha 300x200 mm. s kloubem. Materiál nerezová ocel.
- Ruční sprcha, proti usaz. vod. kamene.
- Flexi hadice SATIN.
- Teleskopická tyč.



00719702

557,00

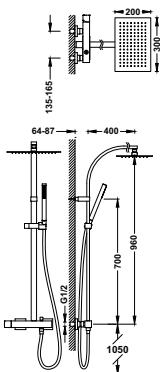

Bar-shower set

- Fixed shower head 300x200 mm. with ball joint. Stainless material.
- Anti-limescale hand shower.
- Satin hose.

Set doccia

- Doccia fissa 300x200 mm. con snodo. Materiale acciaio inossidabile.
- Doccetta anticalcare.
- Flessibile satin.

Sprchová souprava, proti usaz. vod. kamene

- Pevná sprcha 300x200 mm. s kloubem. Materiál nerezová ocel.
- Ruční sprcha, proti usaz. vod. kamene.
- Flexi hadice SATIN.



00719102

625,00

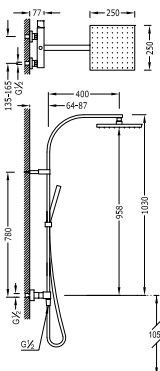

Bar-shower set

- Fixed shower head 250x250 mm. with ball joint.
- Anti-limescale hand shower.
- Satin hose.

Set doccia

- Doccia fissa 250x250 mm. con snodo.
- Doccetta anticalcare.
- Flessibile satin.

Sprchová souprava, proti usaz. vod. kamene

- Pevná sprcha 250x250 mm. s kloubem.
- Ruční sprcha, proti usaz. vod. kamene.
- Flexi hadice SATIN.



00719101

625,00



Bar-shower set

- Fixed shower head 250x250 mm. with ball joint.
- Anti-limescale hand shower.
- Satin hose.
- Telescopic bar.

Set doccia

- Doccia fissa 250x250 mm. con snodo.
- Doccetta anticalcare.
- Flessibile satin.
- Asta telescopica.

Sprchová souprava, proti usaz. vod. kamene

- Pevná sprcha 250x250 mm. s kloubem.
- Ruční sprcha, proti usaz. vod. kamene.
- Flexi hadice SATIN.
- Teleshopická tyč.

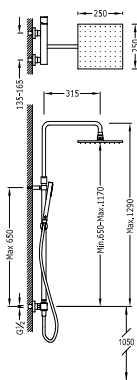

00719701

557,00

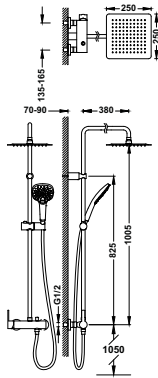
**Bar-shower set**

- Fixed shower head 250x250 mm. with ball joint. Stainless material.
- Anti-limescale hand shower (3 fonctions)
- Satin hose.

Set doccia

- Doccia fissa 250x250 mm. con snodo. Materiale acciaio inossidabile.
- Doccetta anticalcare (3 funzioni).
- Flessibile satin.

Sprchová souprava, proti usaz. vod. kamene

- Pevná sprcha 250x250 mm. s kloubem. Materiál nerezová ocel.
- Ruční sprcha (3 funkci) proti usaz. vod. Kamene
- Flexi hadice SATIN.



08119302

396,00

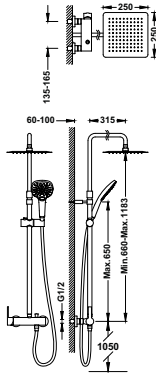
**Bar-shower set**

- Fixed shower head 250x250 mm. with ball joint. Stainless material.
- Anti-limescale hand shower (3 fonctions)
- Satin hose.
- Telescopic bar.

Set doccia

- Doccia fissa 250x250 mm. con snodo. Materiale acciaio inossidabile.
- Doccetta anticalcare (3 funzioni).
- Flessibile satin.
- Asta telescopica.

Sprchová souprava, proti usaz. vod. kamene

- Pevná sprcha 250x250 mm. s kloubem. Materiál nerezová ocel.
- Ruční sprcha (3 funkci) proti usaz. vod. Kamene
- Flexi hadice SATIN.
- Teleskopická tyč.



08119704

435,00

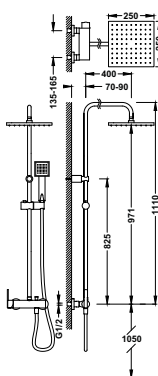
**Bar-shower set**

- Fixed shower head 250x250 mm. with ball joint.
- Anti-limescale hand shower.
- Satin hose.

Set doccia

- Doccia fissa 250x250 mm. con snodo.
- Doccetta anticalcare.
- Flessibile satin.

Sprchová souprava, proti usaz. vod. kamene

- Pevná sprcha 250x250 mm. s kloubem.
- Ruční sprcha, proti usaz. vod. kamene.
- Flexi hadice SATIN.



08119301

396,00

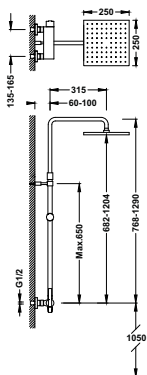

Bar-shower set

- Fixed shower head 250x250 mm. with ball joint.
- Anti-limescale hand shower.
- Satin hose.
- Telescopic bar.

Set doccia

- Doccia fissa 250x250 mm. con snodo.
- Doccetta anticalcare.
- Flessibile satin.
- Asta telescopica.

Sprchová souprava, proti usaz. vod. kamene

- Pevná sprcha 250x250 mm. s kloubem.
- Ruční sprcha, proti usaz. vod. kamene.
- Flexi hadice SATIN.
- Teleshopická tyč.



08119701

435,00

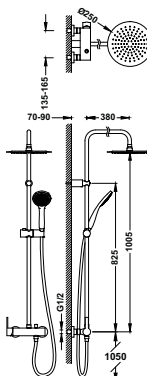

Bar-shower set

- Fixed shower head Ø 250 mm. with ball joint. Stainless material.
- Anti-limescale hand shower.
- Satin hose.

Set doccia

- Doccia fissa Ø 250 mm. con snodo. Materiale acciaio inossidabile.
- Doccetta anticalcare.
- Flessibile satin.

Sprchová souprava, proti usaz. vod. kamene

- Pevná sprcha Ø 250 mm. s kloubem. Materiál nerezová ocel.
- Ruční sprcha, proti usaz. vod. Kamene.
- Flexi hadice SATIN.



1811902

396,00

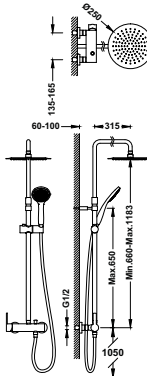

Bar-shower set

- Fixed shower head Ø 250 mm. with ball joint. Stainless material.
- Anti-limescale hand shower.
- Satin hose.
- Telescopic bar.

Set doccia

- Doccia fissa Ø 250 mm. con snodo. Materiale acciaio inossidabile.
- Doccetta anticalcare.
- Flessibile satin.
- Asta telescopica.

Sprchová souprava, proti usaz. vod. kamene

- Pevná sprcha Ø 250 mm. s kloubem. Materiál nerezová ocel.
- Ruční sprcha, proti usaz. vod. Kamene.
- Flexi hadice SATIN.
- Teleshopická tyč.



08119703

435,00

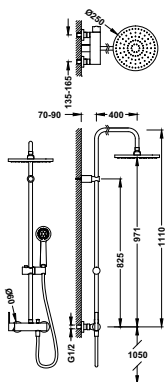
**Bar-shower set**

- Fixed shower head Ø 250 mm. with ball joint.
- Anti-limescale hand shower Ø 80 mm.
- Double interlocked shower hose.

Set doccia

- Doccia fissa Ø 250 mm. con snodo.
- Doccetta anticalcare Ø 80 mm.
- Flessibile doppia graffatura.

Sprchová souprava, proti usaz. vod. kamene

- Pevná sprcha Ø 250 mm. s kloubem.
- Ruční sprcha, proti usaz. vod. kamene Ø 80 mm.
- Flexi hadice s dvojitým zámkem.



9134592

081192

337,00

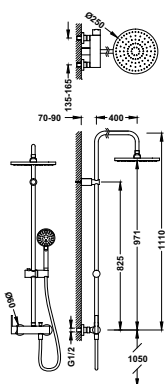
**Bar-shower set**

- Fixed shower head Ø 250 mm. with ball joint.
- Massage hand shower Ø 100 mm. (5 fonctions).
- Satin hose.

Set doccia

- Doccia fissa Ø 250 mm. con snodo.
- Doccetta Ø 100 mm. (5 funzioni).
- Flessibile satin.

Sprchová souprava, proti usaz. vod. kamene

- Pevná sprcha Ø 250 mm. s kloubem.
- Ruční masážní sprcha Ø 100 mm. (5 funkcí).
- Flexi hadice SATIN.



9134592

181191

396,00

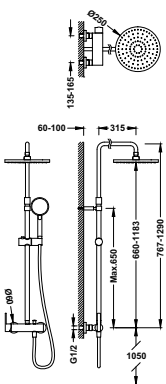
**Bar-shower set**

- Fixed shower head Ø 250 mm. with ball joint.
- Massage hand shower Ø 100 mm. (5 fonctions).
- Satin hose.
- Telescopic bar.

Set doccia

- Doccia fissa Ø 250 mm. con snodo.
- Doccetta Ø 100 mm. (5 funzioni).
- Flessibile satin.
- Asta telescopica.

Sprchová souprava, proti usaz. vod. kamene

- Pevná sprcha Ø 250 mm. s kloubem.
- Ruční masážní sprcha Ø 100 mm. (5 funkcí).
- Flexi hadice SATIN.
- Teleskopická tyč.



9134592

08119702

435,00

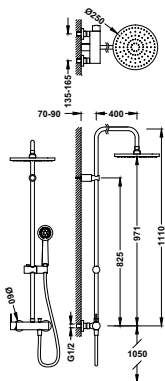

Bar-shower set

- Fixed shower head Ø 250 mm. with ball joint.
- Anti-limescale hand shower.
- Satin hose.

Set doccia

- Doccia fissa Ø 250 mm. con snodo.
- Doccetta anticalcare.
- Flessibile satin.

Sprchová souprava, proti usaz. vod. kamene

- Pevná sprcha Ø 250 mm. s kloubem.
- Ruční sprcha, proti usaz. vod. kamene.
- Flexi hadice SATIN.



20319101

383,00

AD INCASSO / BUILT-IN / VESTAVĚNÉ

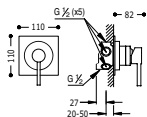
**5-way diverter****With water shut off and flow control**

Distributore 5 vie

Con chiusura e regolazione di portata

Vestavěný pěticestý rozdělovač
uzávěrem a regulací průtoku (1 vstup a 5 výstupů)

134550

230,00

AD INCASSO / BUILT-IN / VESTAVĚNÉ

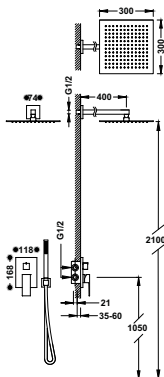
**Concealed shower set RAPID-BOX****with water shut off and flow control.**

- Built-in body included
- Stainless steel fixed shower head 300x300 mm. With ball joint.
- Elbow wall.
- Anti-limescale hand shower.
- Shower hose SATIN.

Kit doccia ad incasso RAPID-BOX

Con chiusura e regolazione di portata.

- Corpo incassato incluso
- Doccia fissa acciaio inossidabile 300x300 mm. con snodo.
- Supporto per doccia.
- Doccetta anticalcare.
- Flessibile satin.

Podomítkový jednopákový sprchový set RAPID-BOX

s uzávěrem a regulací průtoku.

- Včetně podomítkového tělesa
- Pevná sprcha 300x300 mm. s kloboukem. Materiál nerez. oceli.
- Držák s nástěnným přívodem vody
- Ruční sprcha, proti usaz. vod. kamene.
- Flexi hadice SATIN.



00628004

589,00

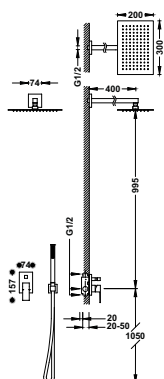
**Concealed shower set****with water shut off and flow control.**

- Built-in body included
- Fixed shower head 300x200 mm. with ball joint. Stainless material.
- Elbow wall.
- Anti-limescale hand shower.
- Satin hose.

Kit doccia ad incasso

Con chiusura e regolazione di portata.

- Corpo incassato incluso
- Doccia fissa 300x200 mm. con snodo. Materiale acciaio inossidabile.
- Supporto per doccia.
- Doccetta anticalcare.
- Flessibile satin.

Podomítkový jednopákový sprchový set

s uzávěrem a regulací průtoku.

- Včetně podomítkového tělesa
- Pevná sprcha 300x200 mm. s kloboukem. Materiál nerezová ocel.
- Držák s nástěnným přívodem vody
- Ruční sprcha, proti usaz. vod. kamene.
- Flexi hadice SATIN.



00698003

505,00

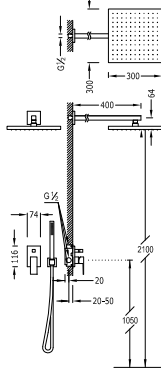

Concealed shower set with water shut off and flow control.

- Built-in body included
- Fixed shower head 300x300 mm. with ball joint. Brass.
- Elbow wall.
- Anti-limescale hand shower.
- Satin hose.

Kit doccia ad incasso

- Con chiusura e regolazione di portata.
- Corpo incassato incluso
 - Doccia fissa 300x300 mm. con snodo. Ottone.
 - Supporto per doccia.
 - Doccetta anticalcare.
 - Flessibile satin..

Podomítkový jednopákový sprchový set

- s uzávěrem a regulací průtoku.
- Včetně podomítkového tělesa
 - Pevná sprcha 300x300 mm. s kloubem. Materiál mosaz.
 - Držák s nástěnným přívodem vody.
 - Ruční sprcha, proti usaz. vod. kamene.
 - Flexi hadice SATIN.



106980

589,00

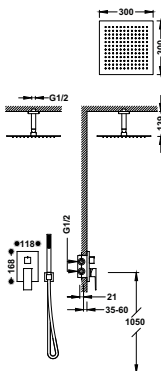

Concealed shower set RAPID-BOX

- with water shut off and flow control.
- Built-in body included
 - Stainless steel fixed shower head 300x300 mm. with ball joint.
 - Elbow wall.
 - Anti-limescale hand shower.
 - Shower hose SATIN.

Kit doccia ad incasso RAPID-BOX

- Con chiusura e regolazione di portata.
- Corpo incassato incluso
 - Doccia fissa acciaio inossidabile 300x300 mm. con snodo.
 - Supporto per doccia.
 - Doccetta anticalcare.
 - Flessibile satin.

Podomítkový jednopákový sprchový set RAPID-BOX

- s uzávěrem a regulací průtoku.
- Včetně podomítkového tělesa
 - Pevná sprcha 300x300 mm. s kloubem. Materiál nerez. oceli.
 - Držák s nástěnným přívodem vody.
 - Ruční sprcha, proti usaz. vod. kamene.
 - Flexi hadice SATIN.



00628003

562,00

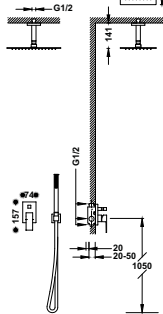

- Concealed shower set with water shut off and flow control.**
- Built-in body included
 - Fixed shower head 300x200 mm. with ball joint. Stainless material.
 - Elbow wall.
 - Anti-limescale hand shower.
 - Satin hose.

- Kit doccia ad incasso**
Con chiusura e regolazione di portata.
- Corpo incassato incluso
 - Doccia fissa 300x200 mm. con snodo. Materiale acciaio inossidabile.
 - Supporto per doccia.
 - Doccetta anticalcare.
 - Flessibile satin.

- Podomítkový jednopákový sprchový set**
s uzavěrem a regulací průtoku.
- Včetně podomítkového tělesa
 - Pevná sprcha 300x200 mm. s kloubem. Materiál nerezová ocel.
 - Držák s nástěnným přívodem vody.
 - Ruční sprcha, proti usaz. vod. Kamene.
 - Flexi hadice SATIN.



00618081

494,00

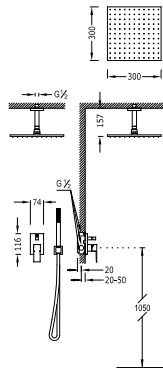

- Concealed shower set with water shut off and flow control.**
- Built-in body included
 - Fixed shower head 300x300 mm. with ball joint. Brass.
 - Elbow wall.
 - Anti-limescale hand shower.
 - Satin hose.

- Kit doccia ad incasso**
Con chiusura e regolazione di portata.
- Corpo incassato incluso
 - Doccia fissa 300x300 mm. con snodo. Ottone.
 - Supporto per doccia.
 - Doccetta anticalcare.
 - Flessibile satin.

- Podomítkový jednopákový sprchový set**
s uzavěrem a regulací průtoku.
- Včetně podomítkového tělesa
 - Pevná sprcha 300x300 mm. s kloubem. Materiál mosaz.
 - Držák s nástěnným přívodem vody.
 - Ruční sprcha, proti usaz. vod. kamene.
 - Flexi hadice SATIN.



00618080

562,00

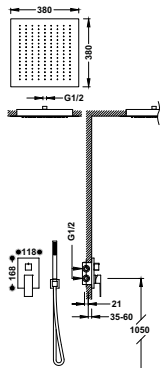

- Concealed shower set RAPID-BOX with water shut off and flow control.**
- Built-in body included
 - Steel shower head 380x380 mm.
 - Elbow wall.
 - Anti-limescale hand shower.
 - Satin hose.

- Kit doccia ad incasso RAPID-BOX**
Con chiusura e regolazione di portata.
- Corpo incassato incluso
 - Soffione doccia acciaio inossidabile 380x380 mm.
 - Supporto per doccia.
 - Doccetta anticalcare.
 - Flessibile satin.

- Podomítkový jednopákový sprchový set RAPID-BOX**
s uzavěrem a regulací průtoku.
- Včetně podomítkového tělesa
 - Sprchové hrobitko z nerez. oceli 380x380 mm.
 - Držák s nástěnným přívodem.
 - Ruční sprcha, proti usaz. vod. kamene.
 - Flexi hadice SATIN.



00628005

876,00

Concealed shower set RAPID-BOX

- with water shut off and flow control.
- Built-in body included.
- Bath spout.
- Elbow wall.
- Anti-limescale hand shower.
- Shower hose SATIN.

Kit doccia ad incasso RAPID-BOX

- Con chiusura e regolazione di portata.
- Corpo incassato incluso.
- Canna per vasca da bagno.
- Supporto per doccia.
- Doccia anticalcare.
- Flessibile satin.

Podomítkový jednopákový sprchový set RAPID-BOX

- s uzávěrem a regulací průtoku.
- Včetně podomítkového tělesa.
- Kohoutek pro vanu.
- Držák s nástěnným přívodem vody.
- Ruční sprcha, proti usaz. vod. kamene.
- Flexi hadice SATIN.

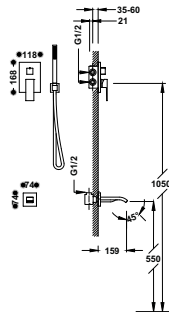

0628006

286,00

Concealed shower set RAPID-BOX

- with water shut off and flow control.
- Built-in body included
- Stainless steel fixed shower head Ø 250 mm. With ball joint.
- Elbow wall.
- Anti-limescale hand shower.
- Shower hose SATIN.

Kit doccia ad incasso RAPID-BOX

- Con chiusura e regolazione di portata.
- Corpo incassato incluso
- Doccia fissa acciaio inossidabile Ø 250 mm. con snodo.
- Supporto per doccia.
- Doccetta anticalcare.
- Flessibile satin.

Podomítkový jednopákový sprchový set RAPID-BOX

- s uzávěrem a regulací průtoku.
- Včetně podomítkového tělesa
- Pevná sprcha Ø 250 mm. s kloubem. Materiál nerez. ocelí.
- Držák s nástěnným přívodem vody
- Ruční sprcha, proti usaz. vod. kamene.
- Flexi hadice SATIN.

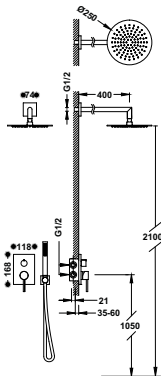

06228004

477,00

Concealed shower set

- with water shut off and flow control.
- Built-in body included
- Fixed shower head Ø 250 mm. with ball joint. Stainless material.
- Elbow wall.
- Anti-limescale hand shower.
- Satin hose.

Kit doccia ad incasso

- Con chiusura e regolazione di portata.
- Corpo incassato incluso
- Doccia fissa Ø 250 mm. con snodo. Materiale acciaio inossidabile.
- Supporto per doccia.
- Doccetta anticalcare.
- Flessibile satin.

Podomítkový jednopákový sprchový set

- s uzávěrem a regulací průtoku.
- Včetně podomítkového tělesa
- Pevná sprcha Ø 250 mm. s kloubem. Materiál nerezová ocel.
- Držák s nástěnným přívodem vody
- Ruční sprcha, proti usaz. vod. kamene.
- Flexi hadice SATIN.

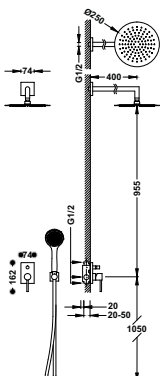

06298004

477,00

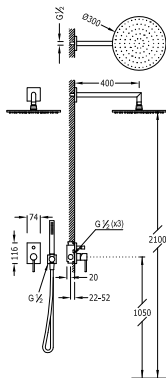
**Concealed shower set**

with water shut off and flow control.

- Built-in body included
- Fixed shower head \varnothing 300 mm. with ball joint. Brass.
- Elbow wall.
- Anti-limescale hand shower.
- Satin hose.

Kit doccia ad incasso

Con chiusura e regolazione di portata.

- Corpo incassato incluso
- Doccia fissa \varnothing 300 mm. con snodo. Ottone.
- Supporto per doccia.
- Doccetta anticalcare.
- Flessibile satin.

Podomítkový jednopákový sprchový set

s uzávěrem a regulací průtoku.

- Včetně podomítkového tělesa
- Pevná sprcha \varnothing 300 mm. s kloubem. Materiál mosaz.
- Držák s nástěnným přívodem vody.
- Ruční sprcha, proti usaz. vod. kamene.
- Flexi hadice SATIN.



9130190

06298001

496,00

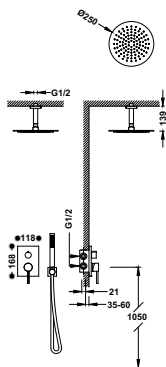
**Concealed shower set RAPID-BOX**

with water shut off and flow control.

- Built-in body included
- Stainless steel fixed shower head \varnothing 250 mm. with ball joint.
- Elbow wall.
- Anti-limescale hand shower.
- Shower hose SATIN.

Kit doccia ad incasso RAPID-BOX

Con chiusura e regolazione di portata.

- Corpo incassato incluso
- Doccia fissa acciaio inossidabile \varnothing 250 mm. con snodo.
- Supporto per doccia.
- Doccetta anticalcare.
- Flessibile satin.

Podomítkový jednopákový sprchový set RAPID-BOX

s uzávěrem a regulací průtoku.

- Včetně podomítkového tělesa
- Pevná sprcha \varnothing 250 mm. s kloubem. Materiál nerez. oceli.
- Držák s nástěnným přívodem vody.
- Ruční sprcha, proti usaz. vod. kamene.
- Flexi hadice SATIN.



29903507

06228003

457,00

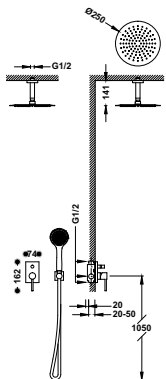
**Concealed shower set**

with water shut off and flow control.

- Built-in body included
- Fixed shower head \varnothing 250 mm. with ball joint. Stainless material.
- Elbow wall.
- Anti-limescale hand shower.
- Satin hose.

Kit doccia ad incasso

Con chiusura e regolazione di portata.

- Corpo incassato incluso
- Doccia fissa \varnothing 250 mm. con snodo. Materiale acciaio inossidabile.
- Supporto per doccia.
- Doccetta anticalcare.
- Flessibile satin.

Podomítkový jednopákový sprchový set

s uzávěrem a regulací průtoku.

- Včetně podomítkového tělesa
- Pevná sprcha \varnothing 250 mm. s kloubem. Materiál nerezová ocel.
- Držák s nástěnným přívodem vody.
- Ruční sprcha, proti usaz. vod. kamene.
- Flexi hadice SATIN.



9130190

06218081

457,00

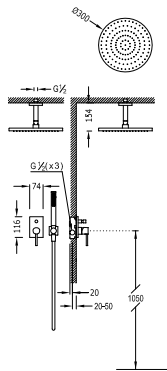

- Concealed shower set**
with water shut off and flow control.
- Built-in body included
 - Fixed shower head \varnothing 300 mm. with ball joint. Brass.
 - Elbow wall.
 - Anti-limescale hand shower.
 - Satin hose.

- Kit doccia ad incasso**
Con chiusura e regolazione di portata.
- Corpo incassato incluso
 - Doccia fissa \varnothing 300 mm. con snodo. Ottone.
 - Supporto per doccia.
 - Doccetta anticalcare.
 - Flessibile satin.

- Podomítkový jednopákový sprchový set*
s uzávěrem a regulací průtoku.
- Včetně podomítkového tělesa
 - Pevná sprcha \varnothing 300 mm. s kloubem. Materiál mosaz
 - Držák s nástěnným přívodem vody.
 - Ruční sprcha, proti usaz. vod. kamene.
 - Flexi hadice SATIN.



06218080

477,00

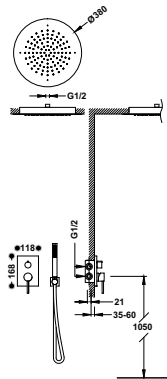

- Concealed shower set RAPID-BOX**
with water shut off and flow control.
- Built-in body included
 - Steel shower head \varnothing 380 mm.
 - Elbow wall.
 - Anti-limescale hand shower.
 - Satin hose.

- Kit doccia ad incasso RAPID-BOX**
Con chiusura e regolazione di portata.
- Corpo incassato incluso
 - Soffione doccia acciaio inossidabile \varnothing 380 mm.
 - Supporto per doccia.
 - Doccetta anticalcare.
 - Flessibile satin.

- Podomítkový jednopákový sprchový set RAPID-BOX*
s uzávěrem a regulací průtoku.
- Včetně podomítkového tělesa
 - Sprchově kropítko z nerez. oceli \varnothing 380 mm.
 - Držák s nástěnným přívodem vody.
 - Ruční sprcha, proti usaz. vod. kamene.
 - Flexi hadice SATIN.



06228005

711,00

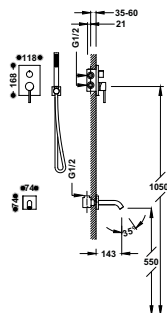

- Concealed shower set RAPID-BOX**
with water shut off and flow control.
- Built-in body included.
 - Bath spout.
 - Elbow wall.
 - Anti-limescale hand shower.
 - Shower hose SATIN.

- Kit doccia ad incasso RAPID-BOX**
Con chiusura e regolazione di portata.
- Corpo incassato incluso.
 - Canna per vasca da bagno.
 - Supporto per doccia.
 - Doccia anticalcare.
 - Flessibile satin.

- Podomítkový jednopákový sprchový set RAPID-BOX*
s uzávěrem a regulací průtoku.
- Včetně podomítkového tělesa.
 - Kahautek pro vanu.
 - Držák s nástěnným přívodem vody.
 - Ruční sprcha, proti usaz. vod. kamene.
 - Flexi hadice SATIN.



06228006

278,00

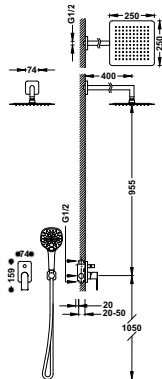

- Concealed shower set with water shut off and flow control.**
- Built-in body included
 - Fixed shower head 250x250 mm. with ball joint. Stainless material.
 - Elbow wall.
 - Anti-limescale hand shower (3 fonctions)
 - Satin hose.

- Kit doccia ad incasso**
Con chiusura e regolazione di portata.
- Corpo incassato incluso
 - Doccia fissa 250x250 mm. con snodo. Materiale acciaio inossidabile.
 - Supporto per doccia.
 - Doccetta anticalcare (3 funzioni).
 - Flessibile satin.

- Podomítkový jednopávkový sprchový set s uzávěrem a regulací průtoku.**
- Včetně podomítkového tělesa
 - Pevná sprcha 250x250 mm. s kloubem. Materiál nerezová ocel.
 - Držák s nástěnným přívodem vody.
 - Ruční sprcha (3 funkce) proti usaz. vod. Kamene
 - Flexi hadice SATIN.



20018011

419,00

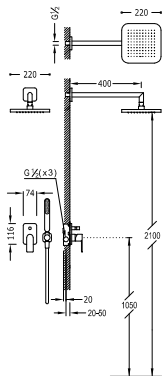

- Concealed shower set with water shut off and flow control.**
- Built-in body included
 - Fixed shower head 220x220 mm. with ball joint.
 - Elbow wall.
 - Anti-limescale hand shower.
 - Satin hose.

- Kit doccia ad incasso**
Con chiusura e regolazione di portata.
- Corpo incassato incluso
 - Doccia fissa 220x220 mm. con snodo.
 - Supporto per doccia.
 - Doccetta anticalcare.
 - Flessibile satin.

- Podomítkový jednopávkový sprchový set s uzávěrem a regulací průtoku.**
- Včetně podomítkového tělesa
 - Pevná sprcha 220x220 mm. s kloubem.
 - Držák s nástěnným přívodem vody.
 - Ruční sprcha, proti usaz. vod. Kamene.
 - Flexi hadice SATIN.



20018002

419,00

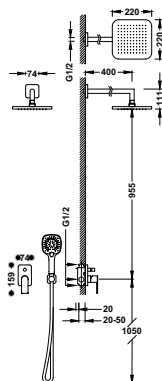

- Concealed shower set with water shut off and flow control.**
- Built-in body included
 - Fixed shower head 220x220 mm. with ball joint.
 - Elbow wall.
 - Anti-limescale hand shower.
 - Satin hose.

- Kit doccia ad incasso**
Con chiusura e regolazione di portata.
- Corpo incassato incluso
 - Doccia fissa 220x220 mm. con snodo.
 - Supporto per doccia.
 - Doccetta anticalcare.
 - Flessibile satin.

- Podomítkový jednopávkový sprchový set s uzávěrem a regulací průtoku.**
- Včetně podomítkového tělesa
 - Pevná sprcha 220x220 mm. s kloubem.
 - Držák s nástěnným přívodem vody.
 - Ruční sprcha, proti usaz. vod. Kamene.
 - Flexi hadice SATIN.



20018007

419,00

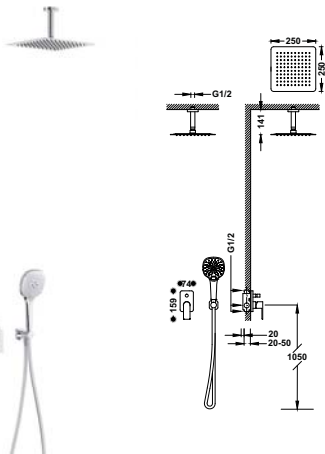

Concealed shower set

with water shut off and flow control.

- Built-in body included
- Fixed shower head 250x250 mm. with ball joint. Stainless material.
- Elbow wall.
- Anti-limescale hand shower (3 fonctions)
- Satin hose.

Kit doccia ad incasso

Con chiusura e regolazione di portata.

- Corpo incassato incluso
- Doccia fissa 250x250 mm. con snodo. Materiale acciaio inossidabile.
- Supporto per doccia.
- Doccetta anticalcare (3 funzioni).
- Flessibile satin.

Podomítkový jednopákový sprchový set

s uzávěrem a regulací průtoku.

- Včetně podomítkového tělesa
- Pevná sprcha 250x250 mm. s kloubem. Materiál nerezová ocel.
- Držák s nástěnným přívodem vody.
- Ruční sprcha (3 funkce) proti usaz. vod. Kamene
- Flexi hadice SATIN.



20018009

399,00

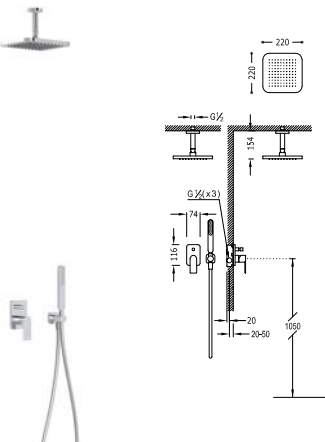

Concealed shower set

with water shut off and flow control.

- Built-in body included
- Fixed shower head 220x220 mm. with ball joint.
- Elbow wall.
- Anti-limescale hand shower.
- Satin hose.

Kit doccia ad incasso

Con chiusura e regolazione di portata.

- Corpo incassato incluso
- Doccia fissa 220x220 mm. con snodo.
- Supporto per doccia.
- Doccetta anticalcare.
- Flessibile satin.

Podomítkový jednopákový sprchový set

s uzávěrem a regulací průtoku.

- Včetně podomítkového tělesa
- Pevná sprcha 220x220 mm. s kloubem.
- Držák s nástěnným přívodem vody.
- Ruční sprcha, proti usaz. vod. Kamene.
- Flexi hadice SATIN.



20018080

399,00

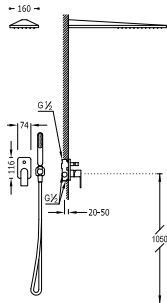
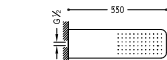

- Concealed shower set**
with water shut off and flow control.
- Built-in body included
 - Stainless steel wall shower 160x550 mm.
 - Elbow wall.
 - Anti-limescale hand shower.
 - Satin hose.

- Kit doccia ad incasso**
Con chiusura e regolazione di portata.
- Corpo incassato incluso
 - Doccia acciaio inossidabile da parete 160x550 mm.
 - Supporto per doccia.
 - Doccetta anticalcare.
 - Flessibile satin.

- Podomítkový jednopákový sprchový set**
s uzávěrem a regulací průtoku.
- Včetně podomítkového tělesa
 - Nástěnné sprchové křepítko z nerez. oceli 160x550 mm.
 - Držák s nástěnným přívodem vody.
 - Ruční sprcha, proti usaz. vod. kamene.
 - Flexi hadice SATIN.



20018005

672,00

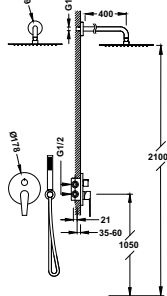
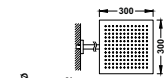

- Concealed shower set RAPID-BOX**
with water shut off and flow control.
- Built-in body included
 - Stainless steel fixed shower head 300x300 mm. With ball joint.
 - Elbow wall.
 - Anti-limescale hand shower.
 - Shower hose SATIN.

- Kit doccia ad incasso RAPID-BOX**
Con chiusura e regolazione di portata.
- Corpo incassato incluso
 - Doccia fissa acciaio inossidabile 300x300 mm. con snodo.
 - Supporto per doccia.
 - Doccetta anticalcare.
 - Flessibile satin.

- Podomítkový jednopákový sprchový set RAPID-BOX**
s uzávěrem a regulací průtoku.
- Včetně podomítkového tělesa
 - Pevná sprcha 300x300 mm. s kloubem. Materiál nerez. oceli.
 - Držák s nástěnným přívodem vody
 - Ruční sprcha, proti usaz. vod. kamene.
 - Flexi hadice SATIN.



20528004

356,00

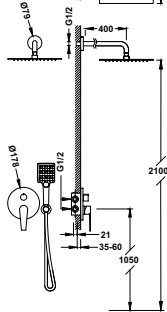
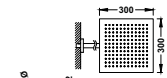

- Concealed shower set RAPID-BOX**
with water shut off and flow control.
- Built-in body included
 - Stainless steel fixed shower head 300x300 mm. With ball joint.
 - Elbow wall.
 - Anti-limescale hand shower 96x110 mm. (3 jet types).
 - Shower hose SATIN.

- Kit doccia ad incasso RAPID-BOX**
Con chiusura e regolazione di portata.
- Corpo incassato incluso
 - Doccia fissa acciaio inossidabile 300x300 mm. con snodo.
 - Supporto per doccia.
 - Doccetta anticalcare 96x110 mm. (3 tipi di getto).
 - Flessibile satin.

- Podomítkový jednopákový sprchový set RAPID-BOX**
s uzávěrem a regulací průtoku.
- Včetně podomítkového tělesa
 - Pevná sprcha 300x300 mm. s kloubem. Materiál nerez. oceli.
 - Držák s nástěnným přívodem vody
 - Ruční sprcha, proti usaz. vod. kamene 96x110 mm. (3 typů proudění vody).
 - Flexi hadice SATIN.



20528040

356,00

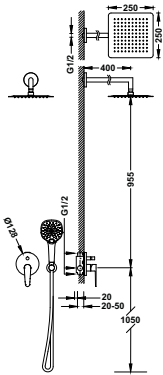

Concealed shower set

with water shut off and flow control.

- Built-in body included
- Fixed shower head 250x250 mm. with ball joint. Stainless material.
- Elbow wall.
- Anti-limescale hand shower (3 fonctions)
- Satin hose.

Kit doccia ad incasso

Con chiusura e regolazione di portata.

- Corpo incassato incluso
- Doccia fissa 250x250 mm. con snodo. Materiale acciaio inossidabile.
- Supporto per doccia.
- Doccetta anticalcare (3 funzioni).
- Flessibile satin.

Podomítkový jednopákový sprchový set

s uzávěrem a regulací průtoku.

- Včetně podomítkového tělesa
- Pevná sprcha 250x250 mm. s kloubem. Materiál nerezová ocel.
- Držák s nástěnným přívodem vody.
- Ruční sprcha (3 funkce) proti usaz. vod. kamene
- Flexi hadice SATIN.



20518006

356,00

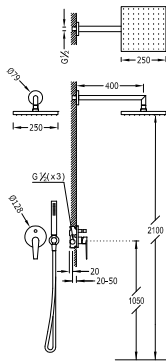

Concealed shower set

with water shut off and flow control.

- Built-in body included
- Fixed shower head 250x250 mm. with ball joint.
- Elbow wall.
- Anti-limescale hand shower.
- Satin hose.

Kit doccia ad incasso

Con chiusura e regolazione di portata.

- Corpo incassato incluso
- Doccia fissa 250x250 mm. con snodo.
- Supporto per doccia.
- Doccetta anticalcare.
- Flessibile satin.

Podomítkový jednopákový sprchový set

s uzávěrem a regulací průtoku.

- Včetně podomítkového tělesa
- Pevná sprcha 250x250 mm. s kloubem.
- Držák s nástěnným přívodem vody.
- Ruční sprcha, proti usaz. vod. kamene.
- Flexi hadice SATIN.



20518002

356,00

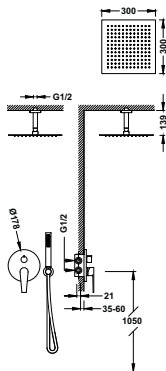

Concealed shower set RAPID-BOX

with water shut off and flow control.

- Built-in body included
- Fixed shower head 300x300 mm. with ball joint. Stainless material.
- Elbow wall.
- Anti-limescale hand shower (3 fonctions)
- Satin hose.

Kit doccia ad incasso RAPID-BOX

Con chiusura e regolazione di portata.

- Corpo incassato incluso
- Doccia fissa 300x300 mm. con snodo. Materiale acciaio inossidabile.
- Supporto per doccia.
- Doccetta anticalcare (3 funzioni).
- Flessibile satin.

Podomítkový jednopákový sprchový set RAPID-BOX

s uzávěrem a regulací průtoku.

- Včetně podomítkového tělesa
- Pevná sprcha 300x300 mm. s kloubem. Materiál nerezová ocel.
- Držák s nástěnným přívodem vody.
- Ruční sprcha (3 funkce) proti usaz. vod. kamene
- Flexi hadice SATIN.



20528003

337,00

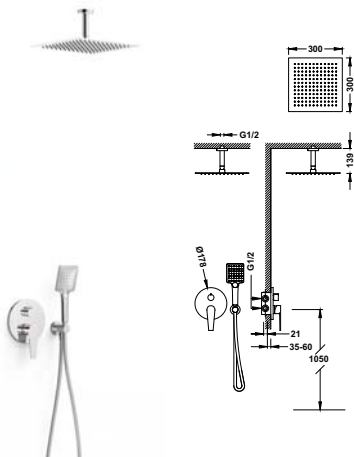

Concealed shower set RAPID-BOX

with water shut off and flow control.

- Built-in body included
- Stainless steel fixed shower head 300x300 mm. with ball joint.
- Elbow wall.
- Anti-limescale hand shower 96x110 mm. (3 jet types).
- Shower hose SATIN.

Kit doccia ad incasso RAPID-BOX

Con chiusura e regolazione di portata.

- Corpo incassato incluso
- Doccia fissa acciaio inossidabile 300x300 mm. con snodo.
- Supporto per doccia.
- Doccetta anticalcare 96x110 mm. (3 tipi di getto).
- Flessibile satin.

Podomítkový jednopákový sprchový set RAPID-BOX

s uzávěrem a regulací průtoku.

- Včetně podomítkového tělesa
- Pevná sprcha 300x300 mm. s kloubem. Materiál nerez. oceli.
- Držák s nástěnným přívodem vody.
- Ruční sprcha, proti usaz. vod. kamene 96x110 mm. (3 typů proudění vody).
- Flexi hadice SATIN.



20528030

337,00

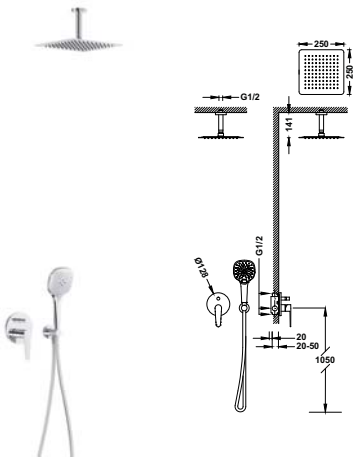

Concealed shower set

with water shut off and flow control.

- Built-in body included
- Fixed shower head 250x250 mm. with ball joint. Stainless material.
- Elbow wall.
- Anti-limescale hand shower (3 fonctions)
- Satin hose.

Kit doccia ad incasso

Con chiusura e regolazione di portata.

- Corpo incassato incluso
- Doccia fissa acciaio inossidabile 250x250 mm. con snodo. Materiale acciaio inossidabile.
- Supporto per doccia.
- Doccetta anticalcare (3 funzioni).
- Flessibile satin.

Podomítkový jednopákový sprchový set

s uzávěrem a regulací průtoku.

- Včetně podomítkového tělesa
- Pevná sprcha 250x250 mm. s kloubem. Materiál nerezová ocel.
- Držák s nástěnným přívodem vody.
- Ruční sprcha (3 funkce) proti usaz. vod. kamene
- Flexi hadice SATIN.



20518007

337,00

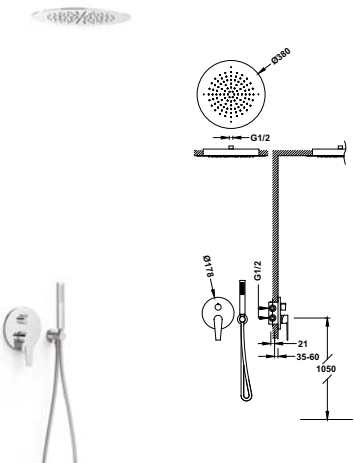

Concealed shower set RAPID-BOX

with water shut off and flow control.

- Built-in body included
- Steel shower head Ø 380 mm.
- Elbow wall.
- Anti-limescale hand shower.
- Shower hose SATIN.

Kit doccia ad incasso RAPID-BOX

Con chiusura e regolazione di portata.

- Corpo incassato incluso
- Soffione doccia acciaio inossidabile Ø 380 mm.
- Supporto per doccia.
- Doccetta anticalcare.
- Flessibile satin.

Podomítkový jednopákový sprchový set RAPID-BOX

s uzávěrem a regulací průtoku.

- Včetně podomítkového tělesa
- Sprchové hroptítko z nerez. oceli Ø 380 mm.
- Držák s nástěnným přívodem vody.
- Ruční sprcha, proti usaz. vod. kamene.
- Flexi hadice SATIN.



20528005

782,00



Concealed shower set RAPID-BOX

- with water shut off and flow control.
- Built-in body included
- Steel shower head Ø 380 mm.
- Elbow wall.
- Anti-limescale hand shower Ø 110 mm. (3 jet types).
- Shower hose SATIN.

Kit doccia ad incasso RAPID-BOX

- Con chiusura e regolazione di portata.
- Corpo incassato incluso
- Soffione doccia acciaio inossidabile Ø 380 mm.
- Supporto per doccia.
- Doccetta anticalcare Ø 110 mm. (3 tipi di getto).
- Flessibile satin.

Podomítkový jednopákový sprchový set RAPID-BOX

- s uzávěrem a regulací průtoku.
- Včetně podomítkového tělesa
- Sprchové kropítko z nerez. oceli Ø 380 mm.
- Držák s nástěnným přívodem vody.
- Ruční sprcha, proti usaz. vod. kamene Ø 110 mm. (3 typů proudění vody).
- Flexi hadice SATIN.

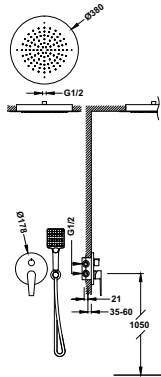

20528050

782,00

Concealed shower set RAPID-BOX

- with water shut off and flow control.
- Built-in body included.
- Bath spout.
- Elbow wall.
- Anti-limescale hand shower.
- Shower hose SATIN.

Kit doccia ad incasso RAPID-BOX

- Con chiusura e regolazione di portata.
- Corpo incassato incluso.
- Canna per vasca da bagno.
- Supporto per doccia.
- Doccetta anticalcare.
- Flessibile satin.

Podomítkový jednopákový sprchový set RAPID-BOX

- s uzávěrem a regulací průtoku.
- Včetně podomítkového tělesa.
- Kohoutek pro vanu.
- Držák s nástěnným přívodem vody.
- Ruční sprcha, proti usaz. vod. kamene.
- Flexi hadice SATIN.

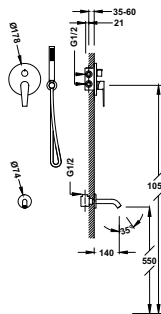

20528006

283,00

Concealed shower set RAPID-BOX

- with water shut off and flow control.
- Built-in body included.
- Bath spout.
- Elbow wall.
- Anti-limescale hand shower Ø 110 mm. (3 jet types).
- Shower hose SATIN.

Kit doccia ad incasso RAPID-BOX

- Con chiusura e regolazione di portata.
- Corpo incassato incluso.
- Canna per vasca da bagno.
- Supporto per doccia.
- Doccetta anticalcare Ø 110 mm. (3 tipi di getto).
- Flessibile satin.

Podomítkový jednopákový sprchový set RAPID-BOX

- s uzávěrem a regulací průtoku.
- Včetně podomítkového tělesa.
- Kohoutek pro vanu.
- Držák s nástěnným přívodem vody.
- Ruční sprcha, proti usaz. vod. kamene Ø 110 mm. (3 typů proudění vody).
- Flexi hadice SATIN.

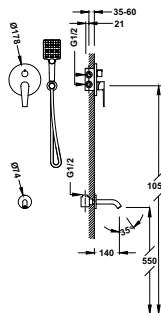

20528060

283,00

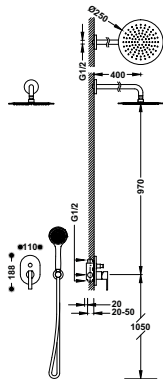

Concealed shower set

with water shut off and flow control.

- Built-in body included
- Fixed shower head Ø 250 mm. with ball joint. Stainless material.
- Elbow wall.
- Anti-limescale hand shower.
- Satin hose.

Kit doccia ad incasso

Con chiusura e regolazione di portata.

- Corpo incassato incluso
- Doccia fissa Ø 250 mm. con snodo. Materiale acciaio inossidabile.
- Supporto per doccia.
- Doccetta anticalcare.
- Flessibile satin.

Podomítkový jednopákový sprchový set

s uzávěrem a regulací průtoku.

- Včetně podomítkového tělesa
- Pevná sprcha Ø 250 mm. s kloubem. Materiál nerezová ocel.
- Držák s nástěnným přívodem vody.
- Ruční sprcha, proti usaz. vod. kamene.
- Flexi hadice SATIN.



08118001

303,00

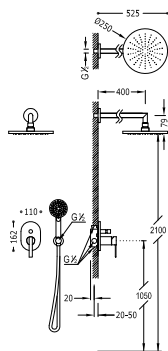

Concealed shower set

with water shut off and flow control.

- Built-in body included
- Fixed shower head Ø 250 mm. with ball joint.
- Elbow wall.
- Massage hand shower Ø 100 mm. (5 fonctions).
- Satin hose.

Kit doccia ad incasso

Con chiusura e regolazione di portata.

- Corpo incassato incluso
- Doccia fissa Ø 250 mm. con snodo.
- Supporto per doccia.
- Doccetta Ø 100 mm. (5 funzioni).
- Flessibile satin.

Podomítkový sprchový set baterie

s uzávěrem a regulací průtoku.

- Včetně podomítkového tělesa
- Pevná sprcha Ø 250 mm. s kloubem.
- Držák s nástěnným přívodem vody.
- Ruční masážní sprcha Ø 100 mm (5 funkcí).
- Flexi hadice SATIN.



18118005

323,00

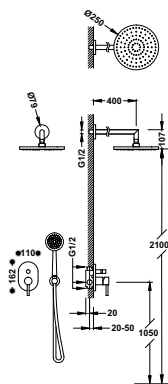

Concealed shower set

with water shut off and flow control.

- Built-in body included
- Fixed shower head Ø 250 mm. with ball joint.
- Elbow wall.
- Anti-limescale hand shower.
- Satin hose.

Kit doccia ad incasso

con chiusura e regolazione di portata.

- Corpo incassato incluso
- Doccia fissa Ø 250 mm. con snodo.
- Supporto per doccia.
- Doccetta anticalcare.
- Flessibile satin.

Sprchový podomítkový set

s uzávěrem a regulací průtoku.

- Včetně podomítkového tělesa
- Pevná sprcha Ø 250 mm. s kloubem.
- Držák s nástěnným přívodem vody.
- Ruční sprcha, proti usaz. vod. kamene.
- Flexi hadice SATIN.



20318002

303,00

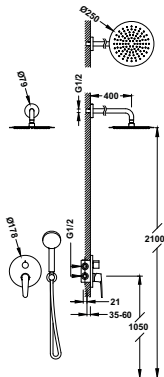

Concealed shower set RAPID-BOX

with water shut off and flow control.

- Built-in body included
- Stainless steel fixed shower head \varnothing 250 mm. With ball joint.
- Elbow wall.
- Anti-limescale hand shower: \varnothing 110 mm.
- Shower hose SATIN.

Kit doccia ad incasso RAPID-BOX

Con chiusura e regolazione di portata.

- Corpo incassato incluso
- Doccia fissa acciaio inossidabile \varnothing 250 mm. con snodo.
- Supporto per doccia.
- Doccetta anticalcare: \varnothing 110 mm.
- Flessibile satin.

Podomítkový jednopákový sprchový set RAPID-BOX

s uzávěrem a regulací průtoku.

- Včetně podomítkového tělesa
- Pevná sprcha \varnothing 250 mm. s kloubem. Materiál nerez. oceli.
- Držák s nástěnným přívodem vody
- Ruční sprcha, proti usaz. vod. kamene. \varnothing 110 mm.
- Flexi hadice SATIN.



20428004

255,00

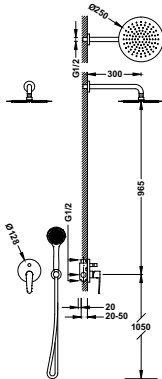

Concealed shower set

with water shut off and flow control.

- Built-in body included
- Fixed shower head \varnothing 250 mm. with ball joint. Stainless material.
- Elbow wall.
- Anti-limescale hand shower.
- Satin hose.

Kit doccia ad incasso

Con chiusura e regolazione di portata.

- Corpo incassato incluso
- Doccia fissa \varnothing 250 mm. con snodo. Materiale acciaio inossidabile.
- Supporto per doccia.
- Doccetta anticalcare.
- Flessibile satin.

Podomítkový jednopákový sprchový set

s uzávěrem a regulací průtoku.

- Včetně podomítkového tělesa
- Pevná sprcha \varnothing 250 mm. s kloubem. Materiál nerezová ocel.
- Držák s nástěnným přívodem vody.
- Ruční sprcha, proti usaz. vod. kamene.
- Flexi hadice SATIN.



20418004

255,00

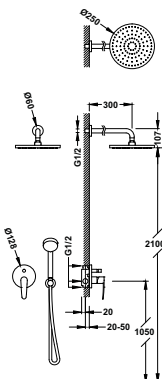

Concealed shower set

with water shut off and flow control.

- Built-in body included
- Fixed shower head \varnothing 250 mm. with ball joint.
- Elbow wall.
- Anti-limescale hand shower.
- Satin hose.

Kit doccia ad incasso

Con chiusura e regolazione di portata.

- Corpo incassato incluso
- Doccia fissa \varnothing 250 mm. con snodo.
- Supporto per doccia.
- Doccetta anticalcare.
- Flessibile satin.

Podomítkový jednopákový sprchový set

s uzávěrem a regulací průtoku.

- Včetně podomítkového tělesa
- Pevná sprcha \varnothing 250 mm. s kloubem.
- Držák s nástěnným přívodem vody.
- Ruční sprcha, proti usaz. vod. kamene.
- Flexi hadice SATIN.



20418002

255,00

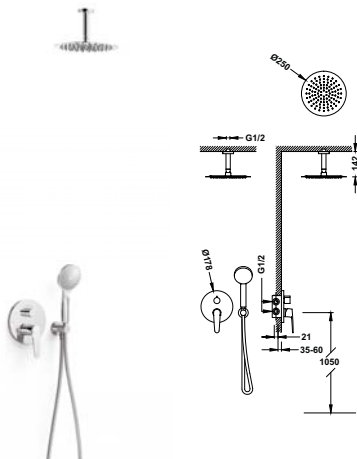

- Concealed shower set RAPID-BOX**
with water shut off and flow control.
- Built-in body included
 - Fixed shower head Ø 250 mm. with ball joint.
 - Elbow wall.
 - Anti-limescale hand shower: Ø 110 mm.
 - Satin hose.

- Kit doccia ad incasso RAPID-BOX**
Con chiusura e regolazione di portata.
- Corpo incassato incluso
 - Doccia fissa Ø 250 mm. con snodo.
 - Supporto per doccia.
 - Doccetta anticalcare: Ø 110 mm.
 - Flessibile satin.

- Podomítkový jednopákový sprchový set RAPID-BOX**
s uzávěrem a regulací průtoku.
- Včetně podomítkového tělesa
 - Pevná sprcha Ø 250 mm. s kloubem.
 - Držák s nástěnným přívodem vody.
 - Ruční sprcha, proti usaz. vod. kamene: Ø 110 mm.
 - Flexi hadice SATIN.



20428003

247,00

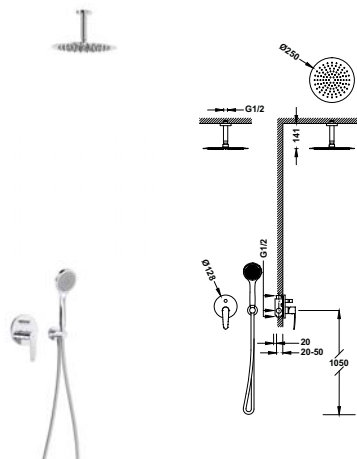

- Concealed shower set**
with water shut off and flow control.
- Built-in body included
 - Fixed shower head Ø 250 mm. with ball joint. Stainless material.
 - Elbow wall.
 - Anti-limescale hand shower.
 - Satin hose.

- Kit doccia ad incasso**
Con chiusura e regolazione di portata.
- Corpo incassato incluso
 - Doccia fissa Ø 250 mm. con snodo. Materiale acciaio inossidabile.
 - Supporto per doccia.
 - Doccetta anticalcare.
 - Flessibile satin.

- Podomítkový jednopákový sprchový set**
s uzávěrem a regulací průtoku.
- Včetně podomítkového tělesa
 - Pevná sprcha Ø 250 mm. s kloubem. Materiál nerezová ocel.
 - Držák s nástěnným přívodem vody.
 - Ruční sprcha, proti usaz. vod. kamene.
 - Flexi hadice SATIN.



20418005

247,00

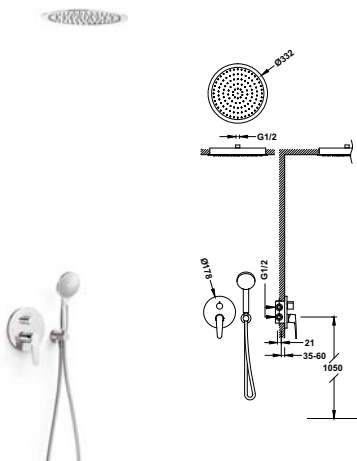

- Concealed shower set RAPID-BOX**
with water shut off and flow control.
- Built-in body included
 - Ceiling shower antilime Ø 330 mm.
 - Elbow wall.
 - Anti-limescale hand shower: Ø 110 mm.
 - Satin hose.

- Kit doccia ad incasso RAPID-BOX**
Con chiusura e regolazione di portata.
- Corpo incassato incluso
 - Soffione doccia anticalcare Ø 330 mm.
 - Supporto per doccia.
 - Doccetta anticalcare: Ø 110 mm.
 - Flessibile satin.

- Podomítkový jednopákový sprchový set RAPID-BOX**
s uzávěrem a regulací průtoku.
- Včetně podomítkového tělesa
 - Stropní sprchové hrobitko Ø 330 mm.
 - Držák s nástěnným přívodem vody.
 - Ruční sprcha, proti usaz. vod. kamene: Ø 110 mm.
 - Flexi hadice SATIN.



20428005

451,00

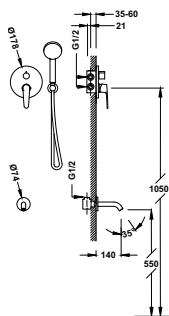

Concealed shower set RAPID-BOX

with water shut off and flow control.

- Built-in body included.
- Bath spout.
- Elbow wall.
- Anti-limescale hand shower \varnothing 110 mm.
- Shower hose SATIN.

Kit doccia ad incasso RAPID-BOX

Con chiusura e regolazione di portata.

- Corpo incassato incluso.
- Canna per vasca da bagno.
- Supporto per doccia.
- Doccetta anticalcare \varnothing 110 mm.
- Flessibile satin.

Podomítkový jednopákový sprchový set RAPID-BOX

s uzávěrem a regulací průtoku.

- Včetně podomítkového tělesa.
- Kohoutek pro vanu.
- Držák s nástěnným přívodem vody.
- Ruční sprcha, proti usaz. vod. Kamene \varnothing 110 mm.
- Flexi hadice SATIN.



20428006

273,00



Tank kit for bath ledges

Kit serbatoio per vasche a mensola

Sada nádrže pro stojánkové vanové baterie

Facilitates installation and guarantees water-tightness

The tank kit allows an over-counter tap to be mounted, facilitating its installation. The patented installation system requires no valve boxes. The tank is watertight and is connected to the bathtub drain, eliminating the water that enters. Supplied with a brass-plated trim plate to improve the finish of the visible part.

Facilita l'installazione e garantisce la tenuta stagna

Il kit serbatoio consente il montaggio superiore del rubinetto a mensola, facilitandone l'installazione. Il sistema di installazione brevettato non ha bisogno di registrazioni. Il serbatoio è a tenuta e comunica con lo scarico della vasca per espellere i resti d'acqua che possono introdursi. Include una placca di ottone cromata estetica per migliorare la finitura della parte visibile.

Usnadňuje instalaci a zaručuje těsnost

Sada pro nádrž umožňuje montáž svrchní baterie a usnadňuje její instalaci. U patentovaného systému nejsou zapotřebí registrace. Nádrž je těsná a připojená k odtoku z vany pro evakuaci případných zbytků vody. Zahrnuta je také mosazná pochromovaná deska určená ke zkrášlení viditelné části.



Bath-shower single lever tap for bracket shelf with shower Anti-limescale.

- Flowrate: 3 bar – 13 l/m.
- Compatible with tank kit ref: 20024501.
- Spout 180 mm.

Monocomando bordo vasca con doccetta anticalcare.

- Portata: 3 bar – 13 l/m.
- Compatibile con il kit serbatoio cod: 20024501.
- Canna 180 mm.

Jednopáková stojánková baterie

Sprcha, proti usaz. vod. kamene.

- Průtok: 3 bar – 13 l/m
- Kompatibilní se sadou nádrže ref. č.: 20024501.
- Ramínko 180 mm.

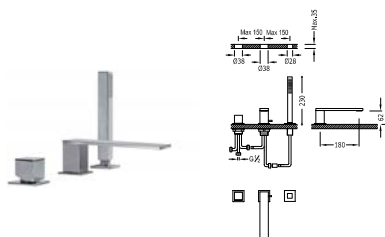

00616106

399,00

Bath-shower single lever tap for bracket shelf with shower Anti-limescale.

- Flowrate: 3 bar – 13 l/m.
- Compatible with tank kit ref: 20024501.
- Spout 220 mm.

Monocomando bordo vasca con doccetta anticalcare.

- Portata: 3 bar – 13 l/m.
- Compatibile con il kit serbatoio cod: 20024501.
- Canna 220 mm.

Jednopáková stojánková baterie

Sprcha proti usaz. vod. kamene.

- Průtok: 3 bar – 13 l/m
- Kompatibilní se sadou nádrže ref. č.: 20024501.
- Ramínko 220 mm.

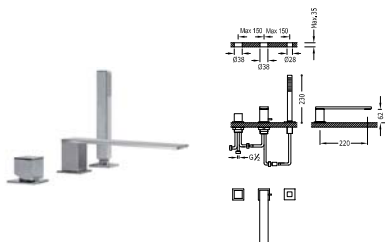

00616104

421,00

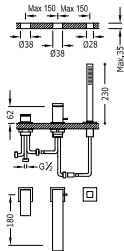
Bath-shower single lever tap for bracket shelf with shower Anti-limescale.

- Flowrate: 3 bar – 13 l/m.
- Compatible with tank kit ref: 20024501.
- Spout 180 mm.

Monocomando bordo vasca

- con doccetta anticalcare.
- Portata: 3 bar – 13 l/m.
- Compatibile con il kit serbatoio cod: 20024501.
- Canna 180 mm.

Jednopávková stojánková baterie

Sprcha, proti usaz. vod. kamene.

- Prútok: 3 bar – 13 l/m
- Kompatibilní se sadou nádrže ref. č.: 20024501.
- Ramínko 180 mm.



00616105

399,00

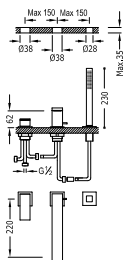
Bath-shower single lever tap for bracket shelf with shower Anti-limescale.

- Flowrate: 3 bar – 13 l/m.
- Compatible with tank kit ref: 20024501.
- Spout 220 mm.

Monocomando bordo vasca

- con doccetta anticalcare.
- Portata: 3 bar – 13 l/m.
- Compatibile con il kit serbatoio cod: 20024501.
- Canna 220 mm.

Jednopávková stojánková baterie

Sprcha, proti usaz. vod. kamene.

- Prútok: 3 bar – 13 l/m
- Kompatibilní se sadou nádrže ref. č.: 20024501.
- Ramínko 220 mm.



00616103

421,00

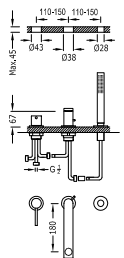
Bath-shower single lever tap for bracket shelf with shower Anti-limescale.

- Flowrate: 3 bar – 16 l/m.
- Compatible with tank kit ref: 20324501.
- Spout 180 mm.

Monocomando bordo vasca

- Doccetta anticalcare.
- Portata: 3 bar – 16 l/m.
- Compatibile con il kit serbatoio cod: 20324501.
- Canna 180 mm.

Jednopávková stojánková vanová baterie

Sprcha, proti usaz. vod. kamene.

- Prútok: 3 bar – 16 l/m
- Kompatibilní se sadou nádrže ref. č.: 20324501.
- Ramínko 180 mm.



06216103

344,00

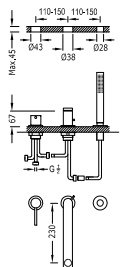
Bath-shower single lever tap for bracket shelf with shower Anti-limescale.

- Flowrate: 3 bar – 16 l/m.
- Compatible with tank kit ref: 20324501.
- Spout 230 mm.

Monocomando bordo vasca

- Doccetta anticalcare.
- Portata: 3 bar – 16 l/m.
- Compatibile con il kit serbatoio cod: 20324501.
- Canna 230 mm.

Jednopávková stojánková vanová baterie

Sprcha, proti usaz. vod. kamene.

- Prútok: 3 bar – 16 l/m
- Kompatibilní se sadou nádrže ref. č.: 20324501.
- Ramínko 230 mm.



06216102

355,00



Bath-shower single lever tap for bracket shelf with shower Anti-limescale.

- Flowrate: 3 bar – 16 l/m.
- Compatible with tank kit ref: 20324501.
- Spout 180 mm.

Monocomando bordo vasca con doccetta anticalcare.

- Portata: 3 bar – 16 l/m.
- Compatibile con il kit serbatoio cod: 20324501.
- Canna 180 mm.

Jednopáková stojánková vanová baterie

Sprcha, proti usaz. vod. kamene.

- Průtok: 3 bar – 16 l/m
- Kompatibilní se sadou nádrže ref. č.: 20324501.
- Ramínko 180 mm.

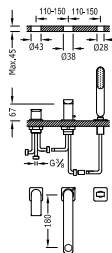

20016203

356,00

Bath-shower single lever tap for bracket shelf with shower Anti-limescale.

- Flowrate: 3 bar – 16 l/m.
- Compatible with tank kit ref: 20324501.
- Spout 220 mm.

Monocomando bordo vasca con doccetta anticalcare.

- Portata: 3 bar – 16 l/m.
- Compatibile con il kit serbatoio cod: 20324501.
- Canna 220 mm.

Jednopáková stojánková vanová baterie

Sprcha, proti usaz. vod. kamene.

- Průtok: 3 bar – 16 l/m
- Kompatibilní se sadou nádrže ref. č.: 20324501.
- Ramínko 220 mm.

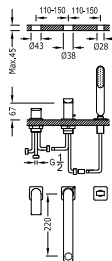

20016201

381,00

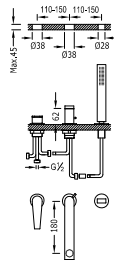

Bath-shower single lever tap for bracket shelf with shower Anti-limescale.

- Flowrate: 3 bar – 13 l/m.
- Compatible with tank kit ref: 20024501.
- Spout 180 mm.

Monocomando bordo vasca

- con doccetta anticalcare.
- Portata: 3 bar – 13 l/m.
 - Compatibile con il kit serbatoio cod: 20024501.
 - Canna 180 mm.

Jednopávková stojánková vanová baterie

- Sprcha, proti usaz. vod. kamene.*
- Průtok: 3 bar – 13 l/m
 - Kompatibilní se sadou nádrže ref. č.: 20024501.
 - Ramínko 180 mm.



20516103

321,00

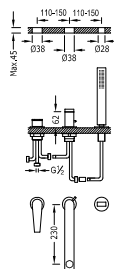

Bath-shower single lever tap for bracket shelf with shower Anti-limescale.

- Flowrate: 3 bar – 13 l/m.
- Compatible with tank kit ref: 20024501.
- Spout 230 mm.

Monocomando bordo vasca

- con doccetta anticalcare.
- Portata: 3 bar – 13 l/m.
 - Compatibile con il kit serbatoio cod: 20024501.
 - Canna 230 mm.

Jednopávková stojánková vanová baterie

- Sprcha, proti usaz. vod. kamene.*
- Průtok: 3 bar – 13 l/m
 - Kompatibilní se sadou nádrže ref. č.: 20024501.
 - Ramínko 230 mm.



20516101

332,00

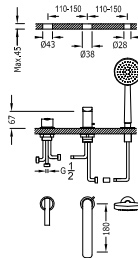

Bath-shower single lever tap for bracket shelf Massage hand shower Ø 100 mm. (5 fonctions).

- Flowrate: 3 bar – 16 l/m.
- Compatible with tank kit ref: 20324501.
- Spout 180 mm.

Monocomando bordo vasca

- Doccetta massaggio Ø 100 mm. (5 funzioni).
- Portata: 3 bar – 16 l/m.
 - Compatibile con il kit serbatoio cod: 20324501.
 - Canna 180 mm.

Jednopávková vanová stojánková baterie

- Ruční masážní sprcha Ø 100 mm. (5 funkcí).*
- Průtok: 3 bar – 16 l/m
 - Kompatibilní se sadou nádrže ref. č.: 20324501.
 - Ramínko 180 mm.



08116104

317,00

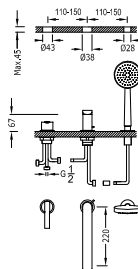

Bath-shower single lever tap for bracket shelf Massage hand shower Ø 100 mm. (5 fonctions).

- Flowrate: 3 bar – 16 l/m.
- Compatible with tank kit ref: 20324501.
- Spout 220 mm.

Monocomando bordo vasca

- Doccetta massaggio Ø 100 mm. (5 funzioni).
- Portata: 3 bar – 16 l/m.
 - Compatibile con il kit serbatoio cod: 20324501.
 - Canna 220 mm.

Jednopávková vanová stojánková baterie

- Ruční masážní sprcha Ø 100 mm. (5 funkcí).*
- Průtok: 3 bar – 16 l/m
 - Kompatibilní se sadou nádrže ref. č.: 20324501.
 - Ramínko 220 mm.



08116103

328,00

Bath-shower single lever tap for bracket shelf

Anti-limescale hand shower.

- Flowrate: 3 bar – 16 l/m.
- Compatible with tank kit ref: 20324501.
- Spout 180 mm.

Monocomando bordo vasca

Doccetta anticalcare.

- Portata: 3 bar – 16 l/m.
- Compatibile con il kit serbatoio cod: 20324501.
- Canna 180 mm.

Jednopávková stojánková vanová baterie

Sprcha, proti usaz. vod. kamene.

- Průtok: 3 bar – 16 l/m
- Kompatibilní se sadou nádrže ref. č.: 20324501.
- Ramínko 180 mm.

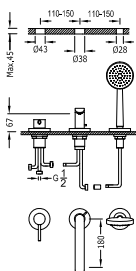

20316102

304,00

Bath-shower single lever tap for bracket shelf

Anti-limescale hand shower.

- Flowrate: 3 bar – 16 l/m.
- Compatible with tank kit ref: 20324501.
- Spout 220 mm.

Monocomando bordo vasca

Doccetta anticalcare.

- Portata: 3 bar – 16 l/m.
- Compatibile con il kit serbatoio cod: 20324501.
- Canna 220 mm.

Jednopávková stojánková vanová baterie

Sprcha, proti usaz. vod. kamene.

- Průtok: 3 bar – 16 l/m
- Kompatibilní se sadou nádrže ref. č.: 20324501.
- Ramínko 220 mm.

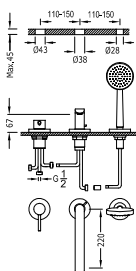

20316101

317,00

Bath-shower single lever tap for bracket shelf

Anti-limescale hand shower.

- Flowrate: 3 bar – 17 l/m.
- Compatible with tank kit ref: 134345.

Batteria bordo vasca

Doccetta anticalcare.

- Portata: 3 bar – 17 l/m.
- Compatibile con il kit serbatoio cod: 134345.

Stojánková vanová baterie

Ruční sprcha, proti usaz. vod. kamene.

- Průtok: 3 bar – 17 l/m
- Kompatibilní se sadou nádrže ref. č.: 134345.

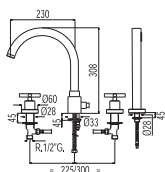

163145

518,00

Bath-shower single lever tap for bracket shelf

Massage hand shower Ø 100 mm. (5 fonctions).

- Flowrate: 3 bar – 14 l/m.
- Compatible with tank kit ref: 189245.

Monocomando bordo vasca

Doccetta massaggio Ø 100 mm. (5 funzioni).

- Portata: 3 bar Ø 100 mm. (5 funzioni).
- Compatibile con il kit serbatoio cod: 189245.

Jednopávková vanová stojánková baterie

Ruční masážní sprcha Ø 100 mm. (5 funkci).

- Průtok: 3 bar – 14 l/m
- Kompatibilní se sadou nádrže ref. č.: 189245.

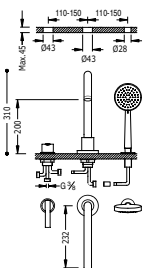

08115001

399,00



**Bath-shower single lever tap for bracket shelf
with cascade cast spout and Anti-limescale hand shower.**

- Flowrate: 3 bar – 13 l/m.
- Compatible with tank kit ref: 106245.

Monocomando bordo vasca

- Con bocca a cascata, doccetta anticalcare.
- Portata: 3 bar – 13 l/m.
- Compatibile con il kit serbatoio cod: 106245.

*Jednopávková vanová stojánková baterie
s ramínek kaskádou. Sprcha, proti usaz. vod. Kamene.*

- Průtok: 3 bar – 13 l/m
- Kompatibilní se sadou nádrže ref. č.: 106245.

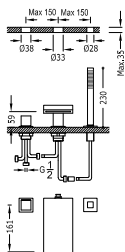

10716102

893,00

**Bath-shower single lever tap for bracket shelf
with cascade cast spout and Anti-limescale hand shower.**

- Flowrate: 3 bar – 13 l/m.
- Compatible with tank kit ref: 106245.

Monocomando bordo vasca

- Con bocca a cascata, doccetta anticalcare.
- Portata: 3 bar – 13 l/m.
- Compatibile con il kit serbatoio cod: 106245.

*Jednopávková vanová stojánková baterie
s ramínek kaskádou. Sprcha, proti usaz. vod. kamene.*

- Průtok: 3 bar – 13 l/m
- Kompatibilní se sadou nádrže ref. č.: 106245.

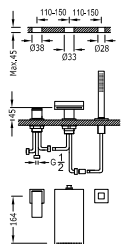

10616102

893,00

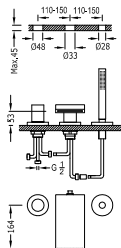

Bath-shower single lever tap for bracket shelf with cascade cast spout and Anti-limescale hand shower.
 · Flowrate: 3 bar – 17 l/m.
 · Compatible with tank kit ref: 162245.

Monocomando bordo vasca

Con bocca a cascata, doccetta anticalcare.
 · Portata: 3 bar – 17 l/m.
 · Compatibile con il kit serbatoio cod: 162245.

Jednopávková stojánková vanová baterie s ramínkem kaskádou. Sprcha, proti usaz. vod. kamene.
 · Průtok: 3 bar – 17 l/m
 · Kompatibilní se sadou nádrže ref. č.: 162245.



06116101

725,00

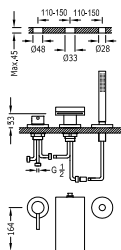

Bath-shower single lever tap for bracket shelf with cascade cast spout and Anti-limescale hand shower.
 · Flowrate: 3 bar – 17 l/m.
 · Compatible with tank kit ref: 162245.

Monocomando bordo vasca

Con bocca a cascata, doccetta anticalcare.
 · Portata: 3 bar – 17 l/m.
 · Compatibile con il kit serbatoio cod: 162245.

Jednopávková stojánková vanová baterie s ramínkem kaskádou. Sprcha, proti usaz. vod. kamene.
 · Průtok: 3 bar – 17 l/m
 · Kompatibilní se sadou nádrže ref. č.: 162245.



162161

725,00

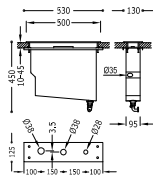
**Bath-shower kit cistern**

Easy upper assembly, without installation (for Nr.: 20216104, 20216102, 20216103, 20216101, 20266102, 20266101).

Kit bordo vasca

Facile montaggio superiore. Senza registro (per ref.: 20216104, 20216102, 20216103, 20216101, 20266102, 20266101).

Set nádrže pro stojánkové vanové baterie

Snadná montáž shora. Bez otvorů (Kód: 20216104, 20216102, 20216103, 20216101, 20266102, 20266101).

20224501

388,00

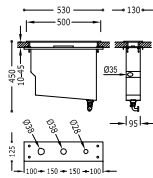
**Bath-shower kit cistern**

Easy upper assembly, without installation (for Nr.: 00616106, 00616104, 00616105, 00616103, 20516103, 20516101).

Kit bordo vasca

Facile montaggio superiore. Senza registro (per ref.: 00616106, 00616104, 00616105, 00616103, 20516103, 20516101).

Set nádrže pro stojánkové vanové baterie

Snadná montáž shora. Bez otvorů (Kód: 00616106, 00616104, 00616105, 00616103, 20516103, 20516101).

20024501

381,00

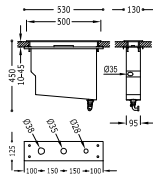
**Bath-shower kit cistern**

Easy upper assembly, without installation (for Nr.: 10716102, 10616102).

Kit bordo vasca

Facile montaggio superiore. Senza registro (per ref.: 10716102, 10616102).

Set nádrže pro stojánkové vanové baterie

Snadná montáž shora. Bez otvorů (Kód: 10716102, 10616102).

106245

381,00

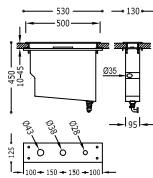
**Bath-shower kit cistern**

Easy upper assembly, without installation (for Nr.: 06216103, 06216102, 20016203, 20016201, 08116104, 08116103, 20316102, 20316101.).

Kit bordo vasca

Facile montaggio superiore. Senza registro (per ref.: 06216103, 06216102, 20016203, 20016201, 08116104, 08116103, 20316102, 20316101.).

Set nádrže pro stojánkové vanové baterie

Snadná montáž shora. Bez otvorů (Kód: 06216103, 06216102, 20016203, 20016201, 08116104, 08116103, 20316102, 20316101.).

20324501

381,00

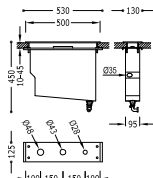
**Bath-shower kit cistern**

Easy upper assembly, without installation (for Nr.: 06116101, 162161, 26115001, 26215001.).

Kit bordo vasca

Facile montaggio superiore. Senza registro (per ref.: 06116101, 162161, 26115001, 26215001.).

Set nádrže pro stojánkové vanové baterie

Snadná montáž shora. Bez otvorů (Kód: 06116101, 162161, 26115001, 26215001.).

162245

381,00

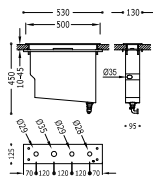
**Bath-shower kit cistern**

Easy upper assembly, without installation (for Nr.: 163145, 132145, 124146.).

Kit bordo vasca

Facile montaggio superiore. Senza registro (per ref.: 163145, 132145, 124146.).

Set nádrže pro stojánkové vanové baterie

Snadná montáž shora. Bez otvorů (Kód: 163145, 132145, 124146.).

134345

396,00

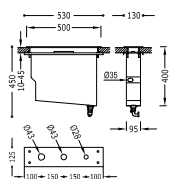

Bath-shower kit cistern

Easy upper assembly, without installation (for Nr.: 08115001).

Kit bordo vasca

Facile montaggio superiore. Senza registro (per ref.: 08115001).

Set nádrž pro stojánkové vanové baterie

Snadná montáž shora. Bez otvorů (Kód: 08115001).

189245

381,00

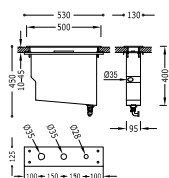

Bath-shower kit cistern

Easy upper assembly, without installation (for Nr.: 14214502).

Kit bordo vasca

Facile montaggio superiore. Senza registro (per ref.: 14214502).

Set nádrž pro stojánkové vanové baterie

Snadná montáž shora. Bez otvorů (Kód: 14214502).

134245

381,00

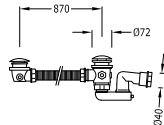

Bath valve with drainage point

Valvola vasca con presa drenaggio

Vanový odpadový ventil

134445

86,00

418 / **Basin mixer taps** | Lavabi | Koupelnová baterie427 / **Bidets** | Bidet | Bidety429 / **Bathtub mixer taps** | Monocomando esterno | Jednoplákový mechanismus vany431 / **Built-in sets** | Monocomando ad incasso | Vestavěné soupravy435 / **Deck-mounted bathtubs** | Bordovasca | Vany s prodlouženým pultem438 / **Thermostatically-controlled** | Termostatica | Termostatické439 / **Shutoff valves** | Rubinetti di arresto | Průchozí ventily



CUADRO-TRES



www.qtrr.es/cuadro-tres



Chrome
Cromato
Chrom



Single lever washbasin mixer

with cascade cast spout. * NOTE: Taps with a cascade spout come with 2 regulation valves and a filter (Nr.: 9134525)

Monocomando lavabo

con bocca a cascata. * NOTA: La rubinetteria con canna a cascata è accompagnata da 2 rubinetti di regolazione con filtro (Ref: 9134525)

Jednopávková umyvadlová baterie
ramínko s vodopádem. * POZNÁMKA: Baterie typu vodopádu je doplněna dvěma regulačními kohouty s filtrem (Kód: 9134525)

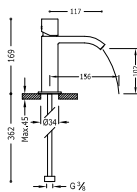

00610102 144,00



29919001

00610102D 163,00

Single lever washbasin mixer

with cascade cast spout. * NOTE: Taps with a cascade spout come with 2 regulation valves and a filter (Nr.: 9134525)

Monocomando lavabo

con bocca a cascata. * NOTA: La rubinetteria con canna a cascata è accompagnata da 2 rubinetti di regolazione con filtro (Ref: 9134525)

Jednopávková umyvadlová baterie
ramínko s vodopádem. * POZNÁMKA: Baterie typu vodopádu je doplněna dvěma regulačními kohouty s filtrem (Kód: 9134525)

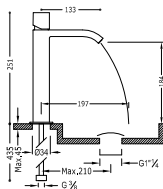

00661002 278,00



29919001

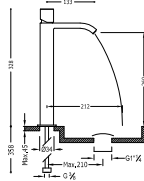

Single lever washbasin mixer
with cascade cast spout. * NOTE: Taps with a cascade spout come with 2 regulation valves and a filter (Nr.: 9134525)

Monocomando lavabo
con bocca a cascata. * NOTA: La rubinetteria con canna a cascata è accompagnata da 2 rubinetti di regolazione con filtro (Ref: 9134525)

Jednopáková umyvadlová baterie
ramínko s vodopádem. * POZNÁMKA: Baterie typu vodopádu je doplněna dvěma regulačními kohouty s filtrem (Kód: 9134525)



00681002 326,00

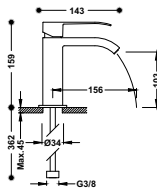

Single lever washbasin mixer
with cascade cast spout. * NOTE: Taps with a cascade spout come with 2 regulation valves and a filter (Nr.: 9134525)

Monocomando lavabo
con bocca a cascata. * NOTA: La rubinetteria con canna a cascata è accompagnata da 2 rubinetti di regolazione con filtro (Ref: 9134525)

Jednopáková umyvadlová baterie
ramínko s vodopádem. * POZNÁMKA: Baterie typu vodopádu je doplněna dvěma regulačními kohouty s filtrem (Kód: 9134525)



00610101 144,00

00610101D 163,00

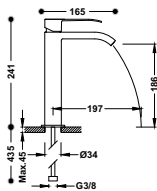

Single lever washbasin mixer
with cascade cast spout. * NOTE: Taps with a cascade spout come with 2 regulation valves and a filter (Nr.: 9134525)

Monocomando lavabo
con bocca a cascata. * NOTA: La rubinetteria con canna a cascata è accompagnata da 2 rubinetti di regolazione con filtro (Ref: 9134525)

Jednopáková umyvadlová baterie
ramínko s vodopádem. * POZNÁMKA: Baterie typu vodopádu je doplněna dvěma regulačními kohouty s filtrem (Kód: 9134525)



00661001 278,00

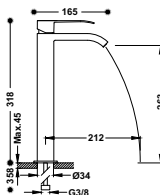

Single lever washbasin mixer
with cascade cast spout. * NOTE: Taps with a cascade spout come with 2 regulation valves and a filter (Nr.: 9134525)

Monocomando lavabo
con bocca a cascata. * NOTA: La rubinetteria con canna a cascata è accompagnata da 2 rubinetti di regolazione con filtro (Ref: 9134525)

Jednopáková umyvadlová baterie
ramínko s vodopádem. * POZNÁMKA: Baterie typu vodopádu je doplněna dvěma regulačními kohouty s filtrem (Kód: 9134525)

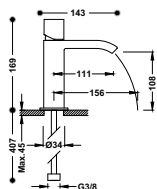

00681001 326,00

**Single lever washbasin mixer**

with open cascade spout. * NOTE: Taps with a cascade spout come with 2 regulation valves and a filter (Nr.: 9134525)

Monocomando lavabo

con bocca a cascata aperta. * NOTA: La rubinetteria con canna a cascata è accompagnata da 2 rubinetti di regolazione con filtro (Ref: 9134525)

Jednopávková umyvadlová baterie

ramínko s otvoreným vodopádem. * POZNÁMKA: Baterie typu vodopádu je doplněna dvěma regulačními kohouty s filtrem (Kód: 9134525)

00611002 238,00

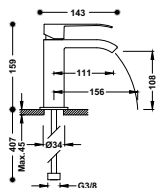

00611002D 254,00

**Single lever washbasin mixer**

with open cascade spout. * NOTE: Taps with a cascade spout come with 2 regulation valves and a filter (Nr.: 9134525)

Monocomando lavabo

con bocca a cascata aperta. * NOTA: La rubinetteria con canna a cascata è accompagnata da 2 rubinetti di regolazione con filtro (Ref: 9134525)

Jednopávková umyvadlová baterie

ramínko s otvoreným vodopádem. * POZNÁMKA: Baterie typu vodopádu je doplněna dvěma regulačními kohouty s filtrem (Kód: 9134525)

00611001 238,00

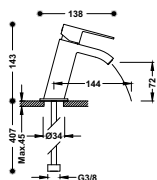

00611001D 254,00

**Single lever washbasin mixer**

with cascade cast spout. NOTE: Taps with a cascade spout come with 2 regulation valves and a filter (Nr.: 9134525)

Monocomando lavabo

con bocca a cascata. NOTA: La rubinetteria con canna a cascata è accompagnata da 2 rubinetti di regolazione con filtro (Ref: 9134525)

Jednopávková umyvadlová baterie

ramínko s vodopádem. POZNÁMKA: Baterie typu vodopádu je doplněna dvěma regulačními kohouty s filtrem (Kód: 9134525)

00620101 144,00



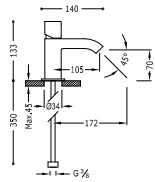

Single lever washbasin mixer with aerator

Monocomando lavabo con aeratore

Jednápáková umyvadlová baterie s perlátorem



9130190

107103

138,00

107103DA

157,00

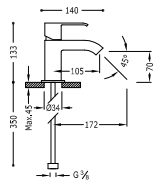

Single lever washbasin mixer with aerator

Monocomando lavabo con aeratore

Jednápáková umyvadlová baterie s perlátorem



9130190

106103

138,00

106103DA

157,00

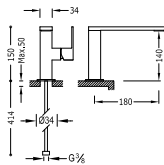

Single lever washbasin mixer spout 34x10 mm.

Monocomando lavabo canna 34x10 mm.

Jednápáková umyvadlová baterie ramínko 34x10 mm



9130190

10620501

228,00

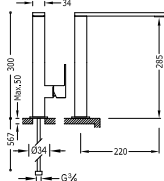

Single lever washbasin mixer spout 34x10 mm.

Monocomando lavabo canna 34x10 mm.

Jednápáková umyvadlová baterie ramínko 34x10 mm



9130190

00648501

323,00

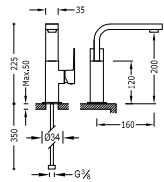

Single lever washbasin mixer spout 35x15 mm.

Monocomando lavabo canna 35x15 mm.

Jednápáková umyvadlová baterie ramínko 35x15 mm



9130190

106603

199,00

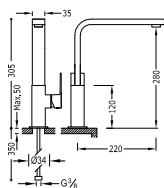

Single lever washbasin mixer spout 35x15 mm.

Monocomando lavabo canna 35x15 mm.

Jednápáková umyvadlová baterie ramínko 35x15 mm



9130190

106604

226,00

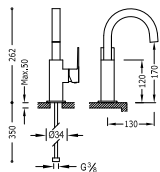

**Single lever washbasin mixer
spout 22x22 mm.**

Monocomando lavabo
canna 22x22 mm.

Jednopáková umyvadlová baterie
ramínko 22x22 mm



106605

220,00

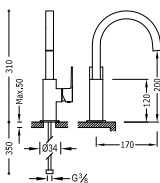

**Single lever washbasin mixer
spout 22x22 mm.**

Monocomando lavabo
canna 22x22 mm.

Jednopáková umyvadlová baterie
ramínko 22x22 mm



106606

231,00

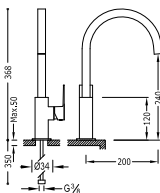

**Single lever washbasin mixer
spout 22x22 mm.**

Monocomando lavabo
canna 22x22 mm.

Jednopáková umyvadlová baterie
ramínko 22x22 mm



106607

245,00

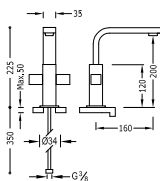

**Single hole mixer
spout 35x15 mm**

Monoblocco verticale
canna 35x15 mm.

Dvoupáková svislá baterie
ramínko 35x15 mm



108604

206,00

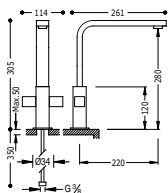

**Single hole mixer
spout 35x15 mm**

Monoblocco verticale
canna 35x15 mm.

*Dvoupáková svislá baterie
ramínko 35x15 mm*



● 910829210 ● 910829220

■ 108496

223,00

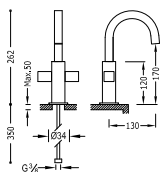

**Single hole mixer
spout 22x22 mm.**

Monoblocco verticale
canna 22x22 mm.

*Dvoupáková svislá baterie
ramínko 22x22 mm*



● 910829210 ● 910829220

■ 108605

206,00

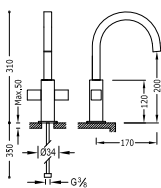

**Single hole mixer
spout 22x22 mm.**

Monoblocco verticale
canna 22x22 mm.

*Dvoupáková svislá baterie
ramínko 22x22 mm*



● 910829210 ● 910829220

■ 108606

211,00

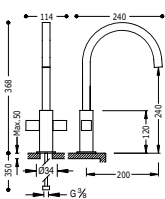

**Single hole mixer
spout 22x22 mm.**

Monoblocco verticale
canna 22x22 mm.

*Dvoupáková svislá baterie
ramínko 22x22 mm*



● 910829210 ● 910829220

■ 108497

223,00

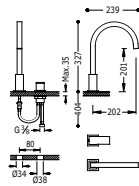

Deck-mounted washbasin mixer tap
Free installation. Spout 22x22 mm.

Monocomando lavabo a mensola
Ad installazione libera. Canna 22x22 mm.

Páková baterie k umyvadlu
Možnosť samostatné instalace. Ramínko 22x22 mm



00610503

201,00

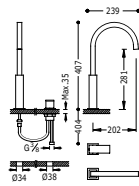

Deck-mounted washbasin mixer tap
Free installation. Spout 22x22 mm.

Monocomando lavabo a mensola
Ad installazione libera. Canna 22x22 mm.

Páková baterie k umyvadlu
Možnosť samostatné instalace. Ramínko 22x22 mm



00610504

206,00

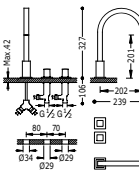

Counter-top dual control tap
Free installation. Spout 22x22 mm.

Doppio comando a mensola
Ad installazione libera. Canna 22x22 mm.

Kohoutková stojánková vanová baterie
Možnosť samostatné instalace. Ramínko 22x22 mm



00810503

232,00

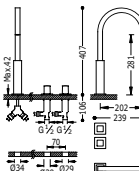

Counter-top dual control tap
Free installation. Spout 22x22 mm.

Doppio comando a mensola
Ad installazione libera. Canna 22x22 mm.

Kohoutková stojánková vanová baterie
Možnosť samostatné instalace. Ramínko 22x22 mm



00810504

239,00

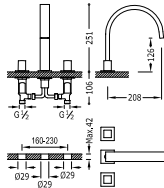

Counter-top dual control tap
Free installation. Tube spout 35x15 mm. Rectangular Aerator
 Doppio comando a mensola
 Ad installazione libera. Canna tubo 35x15 mm. Aeratore rettangolare

Kohoutková stojánková vanová baterie
 Možnost samostatné instalace. Ramínko 35x15 mm se skrytým obdélníkovým perlátorem



00810501

223,00

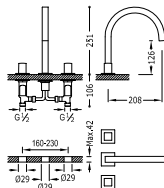

Counter-top dual control tap
Free installation. Spout 22x22 mm.
 Doppio comando a mensola
 Ad installazione libera. Canna 22x22 mm.

Kohoutková stojánková vanová baterie
 Možnost samostatné instalace. Ramínko 22x22 mm



00810502

201,00

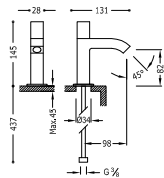

1 water or premixed bathroom tap
Rubinetto lavandino 1 acqua o premiscelata
 Umyvadlová baterie pro jednu nebo předem smíchanou vodu



107503

139,00

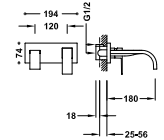

Single lever wall washbasin mixer
Indivisible concealed body with buffers. Anti-moisture seal. Spout 180 mm.
 Monomando a muro
 Corpo a incasso indivisibile con smorzatori. Guarnizione antiumidità. Canna 180 mm.

Jednopávková nástěnná baterie
 Podomítkové těleso v nedělitelném provedení s tlumiči. Těsnění proti vlhkosti. Ramínko 180 mm.



00630011

242,00

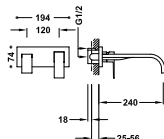

Single lever wall washbasin mixer
Indivisible concealed body with buffers. Anti-moisture seal. Spout 240 mm.
 Monomando a muro
 Corpo a incasso indivisibile con smorzatori. Guarnizione antiumidità. Canna 240 mm.

Jednopávková nástěnná baterie
 Podomítkové těleso v nedělitelném provedení s tlumiči. Těsnění proti vlhkosti. Ramínko 240 mm.



00630012

252,00

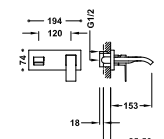

Single lever wall washbasin mixer
with cascade cast spout. Indivisible concealed body with buffers. Anti-moisture seal.
 Monomando a muro
 con bocca a cascata. Corpo a incasso indivisibile con smorzatori. Guarnizione antiumidità.

Jednopávková nástěnná baterie
 ramínko s vodopádem. Podomítkové těleso v nedělitelném provedení s tlumiči. Těsnění proti vlhkosti.



00630013

298,00

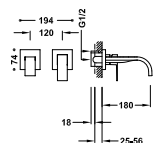

Single lever wall washbasin mixer
Indivisible concealed body with buffers. Anti-moisture seal. Spout 180 mm.

Monomando a muro
Corpo a incasso indivisibile con smorzatori. Guarnizione antiumidità. Canna 180 mm.

Jednopáková nástěnná baterie
Podomítkové těleso v nedělitelném provedení s tlumiči. Těsnění proti vlhkosti. Ramínko 180 mm.



00630001

211,00

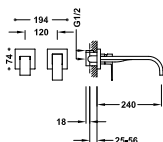

Single lever wall washbasin mixer
Indivisible concealed body with buffers. Anti-moisture seal. Spout 240 mm.

Monomando a muro
Corpo a incasso indivisibile con smorzatori. Guarnizione antiumidità. Canna 240 mm.

Jednopáková nástěnná baterie
Podomítkové těleso v nedělitelném provedení s tlumiči. Těsnění proti vlhkosti. Ramínko 240 mm.



00630002

221,00

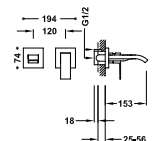

Single lever wall washbasin mixer
with cascade cast spout. Indivisible concealed body with buffers. Anti-moisture seal.

Monomando a muro
con bocca a cascata. Corpo a incasso indivisibile con smorzatori. Guarnizione antiumidità.

Jednopáková nástěnná baterie
ramínko s vodopádem. Podomítkové těleso v nedělitelném provedení s tlumiči. Těsnění proti vlhkosti.



00630003

267,00

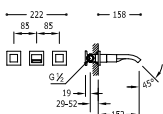

Single hole wall mixer
with cascade cast spout. Built-in body is included and indivisible.

Monoblocco a muro
con bocca a cascata. Corpo incassato incluso e indivisibile.

Nástěnná umyvadlová baterie
ramínko s vodopádem. Včetně nerozdělitelného zabudovaného tělesa.



00815201

312,00

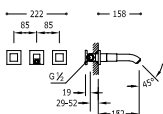

Single hole wall mixer
with aerator. Built-in body is included and indivisible.

Monoblocco a muro
con aeratore. Corpo incassato incluso e indivisibile.

Nástěnná umyvadlová baterie
s perlátorem. Včetně nerozdělitelného zabudovaného tělesa.



00815101

223,00

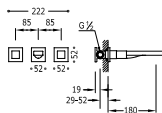

Single hole wall mixer
Built-in body is included and indivisible. Spout 180 mm.

Monoblocco a muro
Corpo incassato incluso e indivisibile. Canna 180 mm.

Nástěnná umyvadlová baterie
Včetně nerozdělitelného zabudovaného tělesa. Ramínko 180 mm.



00815301

223,00

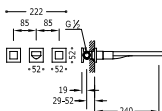

Single hole wall mixer
Built-in body is included and indivisible. Spout 240 mm.

Monoblocco a muro
Corpo incassato incluso e indivisibile. Canna 240 mm.

Nástěnná umyvadlová baterie
Včetně nerozdělitelného zabudovaného tělesa. Ramínko 240 mm.



00815401

228,00

BIDETS | BIDET | BIDETY

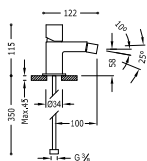

Single lever bidet mixer
Monocomando bidet
Jednopáková bidetová baterie



00712001

143,00

00712001D 162,00

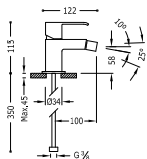

Single lever bidet mixer
Monocomando bidet
Jednopáková bidetová baterie



00612001

143,00

00612001D 162,00

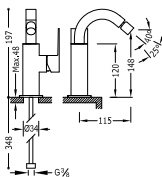

Single lever bidet mixer
Monocomando bidet
Jednopáková bidetová baterie



106124

201,00

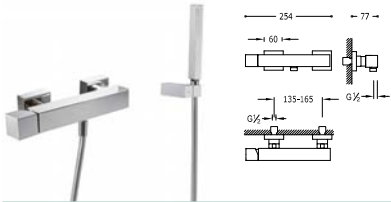

Single lever shower mixer
Anti-limescale hand shower with directable support. Shower hose satin.

Monocomando doccia
Doccetta anticalcare con supporto orientabile. Flessibile satin.

Jednopáková sprchová baterie
Ruční sprcha s nastavitelným držákem, proti usaz. vod. kamene a flexi hadici SATIN.



107167

265,00

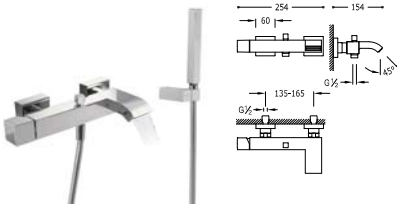

Single lever bath and shower mixer
with cascade. Anti-limescale hand shower with directable support. Shower hose satin.

Monocomando vasca
Con bocca a cascata. Doccetta anticalcare con supporto orientabile. Flessibile satin.

Jednopáková baterie pro vanu-sprchu
s kaskádou. Ruční sprcha s nastavitelným držákem, proti usaz. vod. kamene. Flexi hadice SATIN.



10717002

302,00

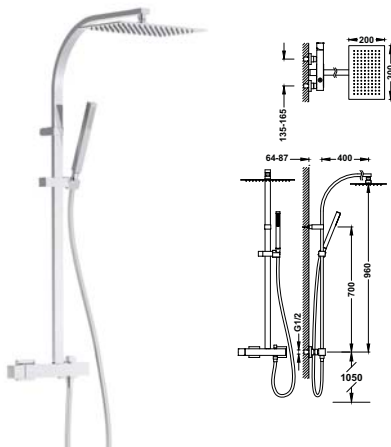

Bar-shower set
· Fixed shower head 300x200 mm. with ball joint. Stainless material.
· Anti-limescale hand shower.
· Satin hose.

Set doccia
· Doccia fissa 300x200 mm. con snodo. Materiale acciaio inossidabile.
· Doccetta anticalcare.
· Flessibile satin.

Sprchová souprava, proti usaz. vod. kamene
· Pevná sprcha 300x200 mm. s kloubem. Materiál nerezová ocel.
· Ruční sprcha, proti usaz. vod. kamene.
· Flexi hadice SATIN.



00719102

625,00

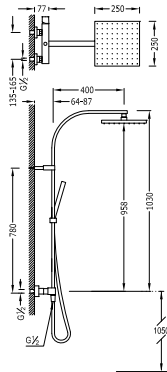
**Concealed shower set**

- Fixed shower head 250x250 mm. with ball joint.
- Anti-limescale hand shower.
- Satin hose.

Kit doccia

- Doccia fissa 250x250 mm. con snodo.
- Doccetta anticalcare.
- Flessibile satin.

Sprchová souprava, proti usaz. vod. kamene

- Pevná sprcha 250x250 mm. s kloubem.
- Ruční sprcha, proti usaz. vod. kamene.
- Flexi hadice SATIN.



9130190

00719101

625,00

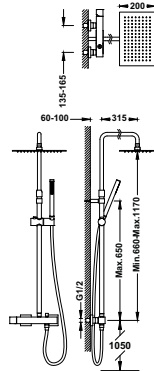
**Bar-shower set**

- Fixed shower head 300x200 mm. with ball joint. Stainless material.
- Anti-limescale hand shower.
- Satin hose.
- Telescopic bar.

Set doccia

- Doccia fissa 300x200 mm. con snodo. Materiale acciaio Inossidabile.
- Doccetta anticalcare.
- Flessibile satin.
- Asta telescopica.

Sprchová souprava, proti usaz. vod. kamene

- Pevná sprcha 300x200 mm. s kloubem. Materiál nerezová ocel.
- Ruční sprcha, proti usaz. vod. kamene.
- Flexi hadice SATIN.
- Teleskopická tyč.



9130190

00719702

557,00

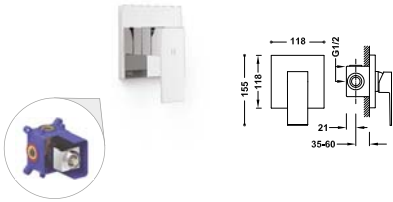

Built-in mixer taps RAPID-BOX (1 way)
 Concealed body with buffers. ABS embedding box. Anti-moisture seal.

Monocomando incasso RAPID-BOX (1 via)
 Corpo a incasso con smorzatori. Scatola da incasso in ABS. Guarnizione antiumidità.

Vestavěná jednopáková baterie RAPID-BOX (jednocestná)
 Podomítkové těleso s tlumiči. Krabice ABS k zabudování do zdi. Těsnění proti vlhkosti.



10627701

117,00

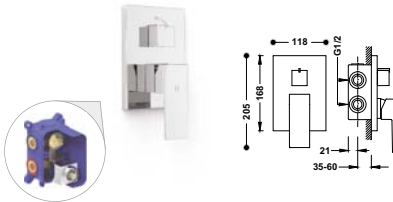

Built-in mixer taps RAPID-BOX (2 way)
 Concealed body with buffers. ABS embedding box. Anti-moisture seal.

Monocomando incasso RAPID-BOX (2 vie)
 Corpo a incasso con smorzatori. Scatola da incasso in ABS. Guarnizione antiumidità.

Vestavěná jednopáková baterie RAPID-BOX (dvoucestná)
 Podomítkové těleso s tlumiči. Krabice ABS k zabudování do zdi. Těsnění proti vlhkosti.



10628001

205,00

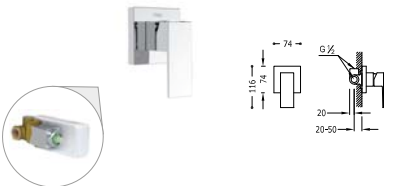

Built-in mixer taps (1 way)
 Built-in body included

Monocomando incasso (1 via)
 corpo incassato incluso

Vestavěná jednopáková sprchová baterie (jednocestná)
 včetně podomítkového tělesa



106177

117,00

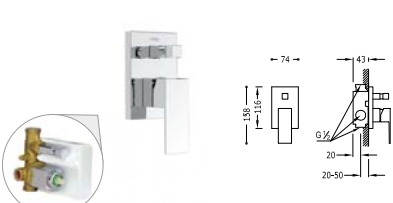

Built-in mixer taps (2 way)
 Built-in body included

Monocomando incasso (2 vie)
 corpo incassato incluso

Vestavěná jednopáková baterie (dvoucestná)
 včetně podomítkového tělesa



106180

205,00



Extension for built-in shower mixer tap
 for Nr: 106177

Prolunga per monocomando incasso doccia
 per ref. 106177

Nástavec pro vestavěnou jednopákovou sprchu
 Kód: 106177

10617710

82,10



Extension for built-in bathtub-shower mixer tap
 for Nr: 106180

Prolunga per monocomando incasso bagno-doccia
 per ref. 106180

Nástavec pro vestavěnou jednopákovou vanu/sprchu
 Kód: 106180

10618010

111,00

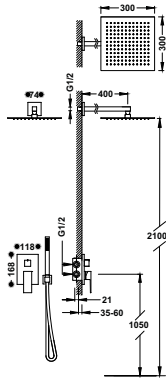
**Concealed shower set RAPID-BOX**

with water shut off and flow control.

- Built-in body included
- Stainless steel fixed shower head 300x300 mm. With ball joint.
- Elbow wall.
- Anti-limescale hand shower.
- Shower hose SATIN.

Kit doccia ad incasso RAPID-BOX

Con chiusura e regolazione di portata.

- Corpo incassato incluso
- Doccia fissa acciaio inossidabile 300x300 mm. con snodo.
- Supporto per doccia.
- Doccetta anticalcare.
- Flessibile satin.

Podomítkový jednopákový sprchový set RAPID-BOX

s uzávěrem a regulací průtoku.

- Včetně podomítkového tělesa
- Pevná sprcha 300x300 mm. s kloboum. Materiál nerez. oceli.
- Držák s nástěnným přívodem vody
- Ruční sprcha, proti usaz. vod. kamene.
- Flexi hadice SATIN.



00628004

589,00

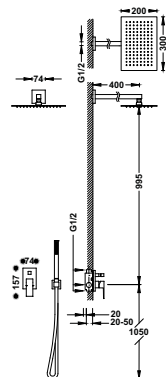
**Concealed shower set**

with water shut off and flow control.

- Built-in body included
- Fixed shower head 300x200 mm. with ball joint. Stainless material.
- Elbow wall.
- Anti-limescale hand shower.
- Satin hose.

Kit doccia ad incasso

Con chiusura e regolazione di portata.

- Corpo incassato incluso
- Doccia fissa 300x200 mm. con snodo. Materiale acciaio inossidabile.
- Supporto per doccia.
- Doccetta anticalcare.
- Flessibile satin.

Podomítkový jednopákový sprchový set

s uzávěrem a regulací průtoku.

- Včetně podomítkového tělesa
- Pevná sprcha 300x200 mm. s kloboum. Materiál nerezová ocel.
- Držák s nástěnným přívodem vody
- Ruční sprcha, proti usaz. vod. kamene.
- Flexi hadice SATIN.



00698003

505,00

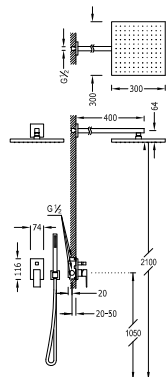
**Concealed shower set**

with water shut off and flow control.

- Built-in body included
- Fixed shower head 300x300 mm. with ball joint. Brass.
- Elbow wall.
- Anti-limescale hand shower.
- Satin hose.

Kit doccia ad incasso

Con chiusura e regolazione di portata.

- Corpo incassato incluso
- Doccia fissa 300x300 mm. con snodo. Ottone.
- Supporto per doccia.
- Doccetta anticalcare.
- Flessibile satin.

Podomítkový jednopákový sprchový set

s uzávěrem a regulací průtoku.

- Včetně podomítkového tělesa
- Pevná sprcha 300x300 mm. s kloboum. Materiál mosaz.
- Držák s nástěnným přívodem vody
- Ruční sprcha, proti usaz. vod. kamene.
- Flexi hadice SATIN.



106980

589,00

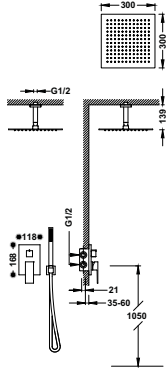

Concealed shower set RAPID-BOX

- with water shut off and flow control.
- Built-in body included
- Stainless steel fixed shower head 300x300 mm. with ball joint.
- Elbow wall.
- Anti-limescale hand shower.
- Shower hose SATIN.

Kit doccia ad incasso RAPID-BOX

- Con chiusura e regolazione di portata.
- Corpo incassato incluso
- Doccia fissa acciaio inossidabile 300x300 mm. con snodo.
- Supporto per doccia.
- Doccetta anticalcare.
- Flessibile satin.

Podomítkový jednopákový sprchový set RAPID-BOX

- s uzávěrem a regulací průtoku.
- Včetně podomítkového tělesa
- Pevná sprcha 300x300 mm. s kloubem. Materiál nerez. oceli.
- Držák s nástěnným přívodem vody.
- Ruční sprcha, proti usaz. vod. kamene.
- Flexi hadice SATIN.



00628003

562,00

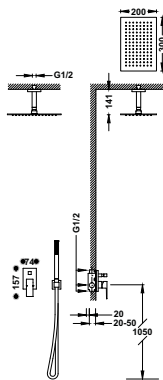

Concealed shower set
with water shut off and flow control.

- Built-in body included
- Fixed shower head 300x200 mm. with ball joint. Stainless material.
- Elbow wall.
- Anti-limescale hand shower.
- Satin hose.

Kit doccia ad incasso

- Con chiusura e regolazione di portata.
- Corpo incassato incluso
- Doccia fissa 300x200 mm. con snodo. Materiale acciaio inossidabile.
- Supporto per doccia.
- Doccetta anticalcare.
- Flessibile satin.

Podomítkový jednopákový sprchový set

- s uzávěrem a regulací průtoku.
- Včetně podomítkového tělesa
- Pevná sprcha 300x200 mm. s kloubem. Materiál nerezová ocel.
- Držák s nástěnným přívodem vody.
- Ruční sprcha, proti usaz. vod. kamene.
- Flexi hadice SATIN.



00618081

494,00

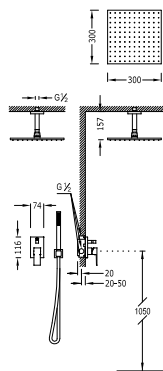

Concealed shower set
with water shut off and flow control.

- Built-in body included
- Fixed shower head 300x300 mm. with ball joint. Brass.
- Elbow wall.
- Anti-limescale hand shower.
- Satin hose.

Kit doccia ad incasso

- Con chiusura e regolazione di portata.
- Corpo incassato incluso
- Doccia fissa 300x300 mm. con snodo. Ottone.
- Supporto per doccia.
- Doccetta anticalcare.
- Flessibile satin.

Podomítkový jednopákový sprchový set

- s uzávěrem a regulací průtoku.
- Včetně podomítkového tělesa
- Pevná sprcha 300x300 mm. s kloubem. Materiál mosaz.
- Držák s nástěnným přívodem vody.
- Ruční sprcha, proti usaz. vod. kamene.
- Flexi hadice SATIN.



00618080

562,00

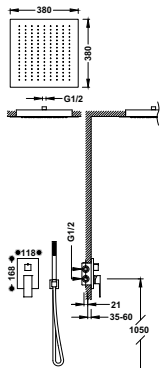
**Concealed shower set RAPID-BOX**

with water shut off and flow control.

- Built-in body included.
- Steel shower head 380x380 mm.
- Elbow wall.
- Anti-limescale hand shower.
- Satin hose.

Kit doccia ad incasso RAPID-BOX

Con chiusura e regolazione di portata.

- Corpo incassato incluso
- Soffione doccia acciaio inossidabile 380x380 mm.
- Supporto per doccia.
- Doccetta anticalcare.
- Flessibile satin.

Podomítkový jednopákový sprchový set RAPID-BOX

s uzávěrem a regulací průtoku.

- Včetně podomítkového tělesa
- Sprchové křepítko z nerez. oceli 380x380 mm.
- Držák s nástěnným přívodem.
- Ruční sprcha, proti usaz. vod. kamene.
- Flexi hadice SATIN.



00628005

876,00

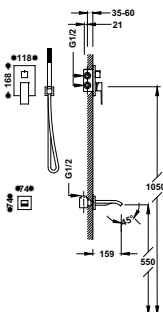
**Concealed shower set RAPID-BOX**

with water shut off and flow control.

- Built-in body included.
- Bath spout.
- Elbow wall.
- Anti-limescale hand shower.
- Shower hose SATIN.

Kit doccia ad incasso RAPID-BOX

Con chiusura e regolazione di portata.

- Corpo incassato incluso.
- Canna per vasca da bagno.
- Supporto per doccia.
- Doccia anticalcare.
- Flessibile satin.

Podomítkový jednopákový sprchový set RAPID-BOX

s uzávěrem a regulací průtoku.

- Včetně podomítkového tělesa.
- Kohoutek pro vanu.
- Držák s nástěnným přívodem vody.
- Ruční sprcha, proti usaz. vod. kamene.
- Flexi hadice SATIN.



00628006

286,00



Bath-shower single lever tap for bracket shelf
with shower Anti-limescale.
- Flowrate: 3 bar – 13 l/m.
- Compatible with tank kit ref: 20024501.
- Spout 180 mm.

Monocomando bordo vasca
con doccetta anticalcare.
- Portata: 3 bar – 13 l/m.
- Compatibile con il kit serbatoio cod: 20024501.
- Canna 180 mm.

Jednopáková stojánková baterie

Sprcha, proti usaz. vod. kamene.
- Průtok: 3 bar – 13 l/m
- Kompatibilní se sadou nádrže ref. č.: 20024501.
- Ramínko 180 mm.

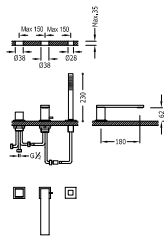

9130190

00616106

399,00

Bath-shower single lever tap for bracket shelf
with shower Anti-limescale.
- Flowrate: 3 bar – 13 l/m.
- Compatible with tank kit ref: 20024501.
- Spout 220 mm.

Monocomando bordo vasca
con doccetta anticalcare.
- Portata: 3 bar – 13 l/m.
- Compatibile con il kit serbatoio cod: 20024501.
- Canna 220 mm.

Jednopáková stojánková baterie

Sprcha proti usaz. vod. kamene.
- Průtok: 3 bar – 13 l/m
- Kompatibilní se sadou nádrže ref. č.: 20024501.
- Ramínko 220 mm.

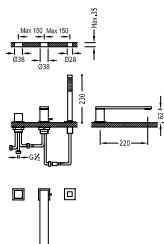

9130190

00616104

421,00

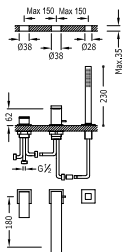
Bath-shower single lever tap for bracket shelf with shower Anti-limescale.

- Flowrate: 3 bar – 13 l/m.
- Compatible with tank kit ref: 20024501.
- Spout 180 mm.

Monocomando bordo vasca con doccetta anticalcare.

- Portata: 3 bar – 13 l/m.
- Compatibile con il kit serbatoio cod: 20024501.
- Canna 180 mm.

Jednopávková stojánková baterie

Sprcha, proti usaz. vod. kamene.

- Prútok: 3 bar – 13 l/m
- Kompatibilní se sadou nádrže ref. č.: 20024501.
- Ramínko 180 mm.



00616105

399,00

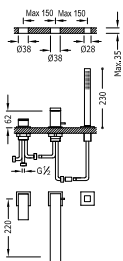
Bath-shower single lever tap for bracket shelf with shower Anti-limescale.

- Flowrate: 3 bar – 13 l/m.
- Compatible with tank kit ref: 20024501.
- Spout 220 mm.

Monocomando bordo vasca con doccetta anticalcare.

- Portata: 3 bar – 13 l/m.
- Compatibile con il kit serbatoio cod: 20024501.
- Canna 220 mm.

Jednopávková stojánková baterie

Sprcha, proti usaz. vod. kamene.

- Prútok: 3 bar – 13 l/m
- Kompatibilní se sadou nádrže ref. č.: 20024501.
- Ramínko 220 mm.



00616103

421,00

Bath-shower kit cistern

Kit bordo vasca

Set nádrže pro stojánkové vanové baterie

(per ref. / for Nr. / Kód: 00616106, 00616104, 00616105, 00616103, 20516103, 20516101).

20024501

381,00

Bath valve with drainage point

Valvola vasca con presa drenaggio

Vanový odpadový ventil

134445

86,00



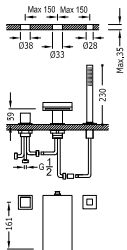

Bath-shower single lever tap for bracket shelf with cascade cast spout and Anti-limescale hand shower.
 - Flowrate: 3 bar – 13 l/m.
 - Compatible with tank kit ref: 106245.

Monocomando bordo vasca

Con bocca a cascata, doccetta anticalcare.
 - Portata: 3 bar – 13 l/m.
 - Compatibile con il kit serbatoio cod: 106245.

Jednopáková vanová stojánková baterie s ramínkem kaskádou. Sprcha, proti usaz. vod. kamene.
 - Průtok: 3 bar – 13 l/m
 - Kompatibilní se sadou nádrže ref. č.: 106245.



10716102

893,00

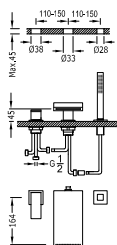

Bath-shower single lever tap for bracket shelf with cascade cast spout and Anti-limescale hand shower.
 - Flowrate: 3 bar – 13 l/m.
 - Compatible with tank kit ref: 106245.

Monocomando bordo vasca

Con bocca a cascata, doccetta anticalcare.
 - Portata: 3 bar – 13 l/m.
 - Compatibile con il kit serbatoio cod: 106245.

Jednopáková vanová stojánková baterie s ramínkem kaskádou. Sprcha, proti usaz. vod. kamene.
 - Průtok: 3 bar – 13 l/m
 - Kompatibilní se sadou nádrže ref. č.: 106245.



10616102

893,00



Bath-shower kit cistern

Kit bordo vasca

Set nádrže pro stojánkové vanové baterie

(per ref. / for Nr. / Kód: 10716102, 10616102).

106245

381,00



Bath valve with drainage point

Valvola vasca con presa drenaggio

Vanový odpadový ventil

134445

86,00

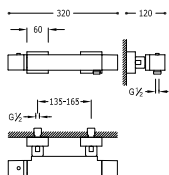

Wall thermostatic shower mixer

Doccia termostatica
Termostatická sprchová baterie



107164

304,00

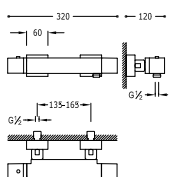

Wall thermostatic shower mixer

(Anti-limescale hand shower with directable support. Shower hose satin).

Doccia termostatica
(Doccetta anticalcare con supporto orientabile. Flesso satinato).

Termostatická sprchová baterie
(Ruční sprcha s nastavitelným držákem, proti usaz. vod. kamene. Flexi hadice SATIN (91.34.609.15))



1071649

340,00

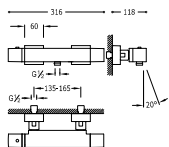

Wall thermostatic bath and shower mixer

with cascade. Diverter integrated in the flow control.

Vasca-Doccia termostatica
con cascata. Invertitore integrato nel regolatore di portata.

Termostatická baterie pro vanu-sprchu
s kaskádou. Přepínač zabudovaný v regulaci průtoku.



107174

357,00

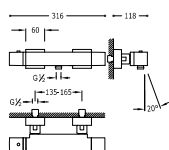

Wall thermostatic bath and shower mixer

with cascade (Anti-limescale hand shower with directable support. Shower hose satin). Diverter integrated in the flow control.

Vasca-Doccia termostatica
Con bocca a cascata (Doccetta anticalcare con supporto orientabile. Flesso satinato). Invertitore integrato nel regolatore di portata.

Termostatická baterie pro vanu-sprchu
s kaskádou (Ruční sprcha s nastavitelným držákem, proti usaz. vod. kamene. Flexi hadice SATIN). Přepínač zabudovaný v regulaci průtoku.



1071749

404,00

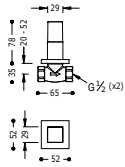

1/2" threaded-ends gate-valve
Rubinetto di arresto filettato 1/2"
Uzavírací ventil 1/2"

00715501

74,80

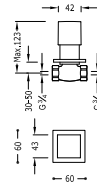

3/4" threaded-ends gate-valve
Rubinetto di arresto filettato 3/4"
Uzavírací ventil 3/4"

107511

82,10

442 / **Basin mixer taps** | Lavabi | Koupelňová baterie449 / **Bidets** | Bidet | Bidety450 / **Bathtub mixer taps** | Monocomando esterno | Jednoplákový mechanismus vany452 / **Built-in sets** | Monocomando ad incasso | Vestavěné soupravy456 / **Deck-mounted bathtubs** | Bordovasca | Vany s prodlouženým pultem458 / **Thermostatically-controlled** | Termostatica | Termostatické461 / **Shutoff valves** | Rubinetti di arresto | Průchozí ventily

TRÉS

MAX-TRES

F



www.qrtr.es/max-tres



Chrome
Cromato
Chrom

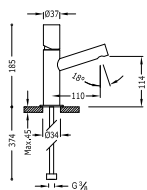

Single lever washbasin mixer
Monocomando lavabo
Jednopáková umyvadlová baterie



06110301 131,00

06110301D 148,00

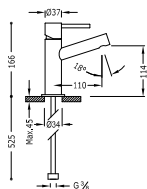

Single lever washbasin mixer
Monocomando lavabo
Jednopáková umyvadlová baterie



06210301 131,00

06210301D 148,00

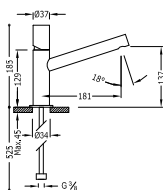

Single lever washbasin mixer
long spout
Monocomando lavabo
canna lunga
*Jednopáková umyvadlová baterie
dlouhé ramínko*



06120301 154,00

06120301D 172,00

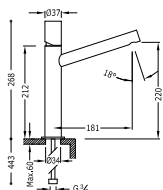

Single lever washbasin mixer
long spout
Monocomando lavabo
canna lunga
*Jednopáková umyvadlová baterie
dlouhé ramínko*



06120601 202,00

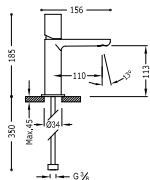

Single lever washbasin mixer
Monocomando lavabo
Jednopáková umyvadlová baterie



06110302 **115,00**

06110302D **135,00**

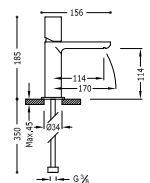

Single lever washbasin mixer
NOTE: Taps with a cascade spout come with 2 regulation valves and a filter (Nr.: 9134525)
Monocomando lavabo

NOTA: La rubinetteria con canna a cascata è accompagnata da 2 rubinetti di regolazione con filtro (Ref. 9134525)

Jednopáková umyvadlová baterie

POZNÁMKA: Baterie typu vodopádu je doplněna dvěma regulačními kohouty s filtrem (Kód: 9134525)



06110303 **135,00**

06110303D **152,00**

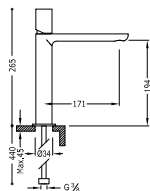

Single lever washbasin mixer
Monocomando lavabo
Jednopáková umyvadlová baterie



06120304 **208,00**

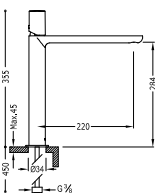

Single lever washbasin mixer
Monocomando lavabo
Jednopáková umyvadlová baterie



06120306 **231,00**

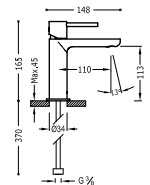

Single lever washbasin mixer
Monocomando lavabo
Jednopáková umyvadlová baterie



06210302 **115,00**

06210302D **135,00**

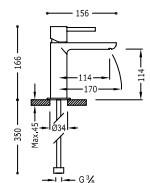

Single lever washbasin mixer
NOTE: Taps with a cascade spout come with 2 regulation valves and a filter (Nr.: 9134525)
Monocomando lavabo

NOTA: La rubinetteria con canna a cascata è accompagnata da 2 rubinetti di regolazione con filtro (Ref. 9134525)

Jednopáková umyvadlová baterie

POZNÁMKA: Baterie typu vodopádu je doplněna dvěma regulačními kohouty s filtrem (Kód: 9134525)



06210303 **135,00**

06210303D **152,00**

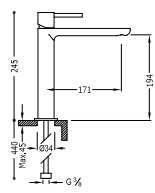

Single lever washbasin mixer
Monocomando lavabo
Jednopáková umyvadlová baterie



06220304 **208,00**

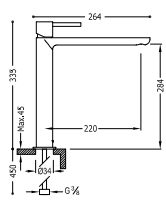

Single lever washbasin mixer
Monocomando lavabo
Jednopáková umyvadlová baterie



06220306 **231,00**

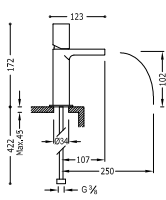

Single lever washbasin mixer
with open cascade spout. NOTE: Taps with a cascade spout come with 2 regulation valves and a filter (Nr.: 9134525)

Monocomando lavabo
 con bocca a cascata aperta. **NOTA:** La rubinetteria con canna a cascata è accompagnata da 2 rubinetti di regolazione con filtro (Ref: 9134525)

Jednopáková umyvadlová baterie ramínko s otevřeným vodopádem. POZNÁMKA: Baterie typu vodopádu je doplněna dvěma regulačními kohouty s filtrem (Kód.: 9134525)



9134525 06111001 **194,00**

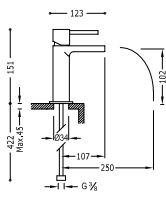

Single lever washbasin mixer
with open cascade spout. NOTE: Taps with a cascade spout come with 2 regulation valves and a filter (Nr.: 9134525)

Monocomando lavabo
 con bocca a cascata aperta. **NOTA:** La rubinetteria con canna a cascata è accompagnata da 2 rubinetti di regolazione con filtro (Ref: 9134525)

Jednopáková umyvadlová baterie ramínko s otevřeným vodopádem. POZNÁMKA: Baterie typu vodopádu je doplněna dvěma regulačními kohouty s filtrem (Kód.: 9134525)



9134525 06211001 **194,00**

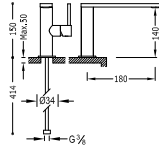

**Single lever washbasin mixer
spout 34x9 mm.**

Monocomando lavabo
canna 34x9 mm.

Jednopáková umyvadlová baterie
ramínko 34x9 mm



9130190

06290503

171,00

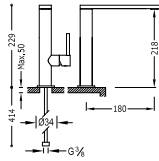

**Single lever washbasin mixer
spout 34x9 mm.**

Monocomando lavabo
canna 34x9 mm.

Jednopáková umyvadlová baterie
ramínko 34x9 mm



9130190

06290502

189,00

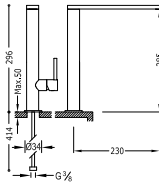

**Single lever washbasin mixer
spout 34x9 mm.**

Monocomando lavabo
canna 34x9 mm.

Jednopáková umyvadlová baterie
ramínko 34x9 mm



9130190

06290501

225,00



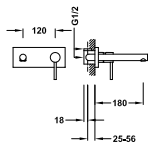

Single lever wall washbasin mixer
Indivisible concealed body with buffers. Anti-moisture seal. Spout 180 mm.

Monomando a muro
Corpo a incasso indivisibile con smorzatori. Guarnizione antiumidità. Canna 180 mm.

Jednopáková nástěnná baterie
Podomítkové těleso v nedělitelném provedení s tlumiči. Těsnění proti vlhkosti. Ramínko 180 mm.



0623001

246,00

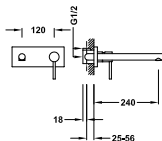

Single lever wall washbasin mixer
Indivisible concealed body with buffers. Anti-moisture seal. Spout 240 mm.

Monomando a muro
Corpo a incasso indivisibile con smorzatori. Guarnizione antiumidità. Canna 240 mm.

Jednopáková nástěnná baterie
Podomítkové těleso v nedělitelném provedení s tlumiči. Těsnění proti vlhkosti. Ramínko 240 mm.



0623002

257,00

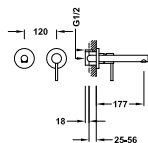

Single lever wall washbasin mixer
Indivisible concealed body with buffers. Anti-moisture seal. Spout 177 mm.

Monomando a muro
Corpo a incasso indivisibile con smorzatori. Guarnizione antiumidità. Canna 177 mm.

Jednopáková nástěnná baterie
Podomítkové těleso v nedělitelném provedení s tlumiči. Těsnění proti vlhkosti. Ramínko 177 mm.



06230001

201,00

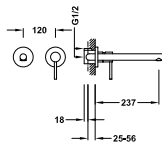

Single lever wall washbasin mixer
Indivisible concealed body with buffers. Anti-moisture seal. Spout 237 mm.

Monomando a muro
Corpo a incasso indivisibile con smorzatori. Guarnizione antiumidità. Canna 237 mm.

Jednopáková nástěnná baterie
Podomítkové těleso v nedělitelném provedení s tlumiči. Těsnění proti vlhkosti. Ramínko 237 mm.



06230002

211,00

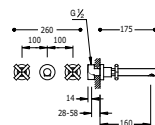

Single hole wall mixer
Built-in body is included and indivisible. Spout 160 mm.

Monoblocco a muro
Corpo incassato incluso e indivisibile. Canna 160 mm.

Nástěnná umyvadlová baterie
Včetně nerezávitelného zabudovaného tělesa. Ramínko 160 mm.



163152

270,00

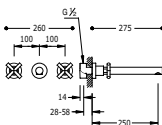

Single hole wall mixer
Built-in body is included and indivisible. Spout 250 mm.

Monoblocco a muro
Corpo incassato incluso e indivisibile. Canna 250 mm.

Nástěnná umyvadlová baterie
Včetně nerezávitelného zabudovaného tělesa. Ramínko 250 mm.



163151

280,00

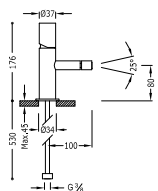

Single lever bidet mixer
Monocomando bidet
Jednopáková bidetová baterie



910719005

- 06112001 **131,00**
- 06112001D **148,00**

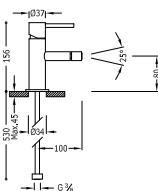

Single lever bidet mixer
Monocomando bidet
Jednopáková bidetová baterie



910719005

- 06212001 **131,00**
- 06212001D **148,00**

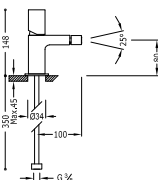

Single lever bidet mixer
Monocomando bidet
Jednopáková bidetová baterie



9130190

- 06122001 **115,00**
- 06122001D **135,00**

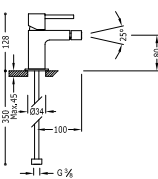

Single lever bidet mixer
Monocomando bidet
Jednopáková bidetová baterie



9130190

- 06222001 **115,00**
- 06222001D **135,00**

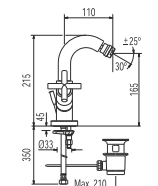

Single hole bidet mixer
Monoblocco bidet
Dvoupáková bidetová baterie



9134282

- 163120 **220,00**
- 168120 **239,00**

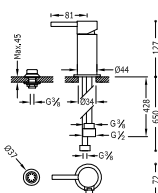

Bidet mixer tap with small shower head
Monocomando bidet con doccia
Jednopáková bidetová baterie se sprškou



9134592

- 06213001 **121,00**

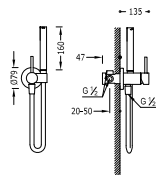

Concealed single lever bidet/toilets

Left or right support, interchangeable. Sateen hose.

Monocomando ad incasso per bidè WC
Supporto a destra o a sinistra, intercambiabile. Flesso satinato.

Jednopávková podomítková baterie pro bidet WC
Vyměnitelný držák zprava či zleva. Sprchová mosazná baterie s omezovacím hrdlem 5 l/m. Systém proti kapání a flexi hadice SATIN



134123

159,00

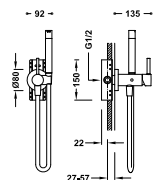

Concealed single lever bidet/toilets

Left or right support, interchangeable. Sateen hose. Opție gips

Monocomando ad incasso per bidè WC
Supporto a destra o a sinistra, intercambiabile. Flesso satinato.
Opzione Cartongesso

Jednopávková podomítková baterie pro bidet WC
Vyměnitelný držák zprava či zleva. Sprchová mosazná baterie s omezovacím hrdlem 5 l/m. Systém proti kapání a flexi hadice SATIN. Možnost pro sádrokartonové panely



134122

199,00



Accessory towel racks

180 mm. (for Nr.: 134122, 134123, 181122, 181123, 181222, 181223, 20522201, 20522301). NOTE: Left or right support, interchangeable.

Accessori portasciugamani

180 mm. (per ref.: 134122, 134123, 181122, 181123, 181222, 181223, 20522201, 20522301). NOTA: Supporto a destra o a sinistra, intercambiabile.

Príslušenství držák na ručníky

180 mm. (Kód: 134122, 134123, 181122, 181123, 181222, 181223, 20522201, 20522301). POZNÁMKA: Právý nebo levý podstavec, vyměnitelný.



03412401

32,00

BATHTUB MIXER TAPS | MONOCOMANDI BAGNO | JEDNOPÁVKOVÝ MECHANISMUS VANY

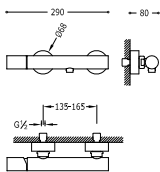

Single lever shower mixer

Anti-limescale hand shower with directable support. Shower hose satin.

Monocomando doccia
Doccetta anticalcare con supporto orientabile. Flessibile satin.

Sprchová baterie
Ruční sprcha s nastavitelným držákem, proti usaz. vod. kamene a flexi hadice SATIN.



06116701

206,00

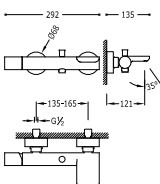

Single lever bath and shower mixer

with cascade. Anti-limescale hand shower with directable support. Shower hose satin.

Monocomando vasca
Con bocca a cascata. Doccetta anticalcare con supporto orientabile. Flessibile satin.

Vanová baterie
s kaskádou. Ruční sprcha s nastavitelným držákem, proti usaz. vod. kamene a flexi hadice SATIN.



06117001

230,00

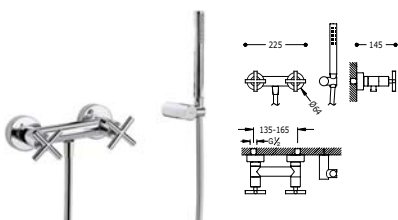

Shower mixer

Anti-limescale hand shower with directable support. Shower hose satin.

Gruppo doccia

Doccetta anticalcare con supporto orientabile. Flessibile satin.

Sprchový set

Ruční sprcha s nastavitelným držákem, proti usaz. vod. kamene a flexi hadice SATIN.



163868

272,00

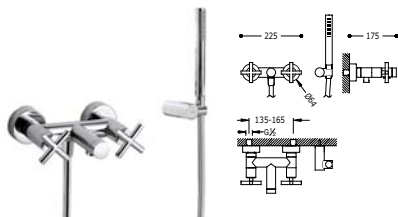

Bath and shower mixer

Anti-limescale hand shower with directable support. Shower hose satin.

Gruppo vasca

Doccetta anticalcare con supporto orientabile. Flessibile satin.

Vanový set

Ruční sprcha s nastavitelným držákem, proti usaz. vod. kamene a flexi hadice SATIN.



163874

345,00

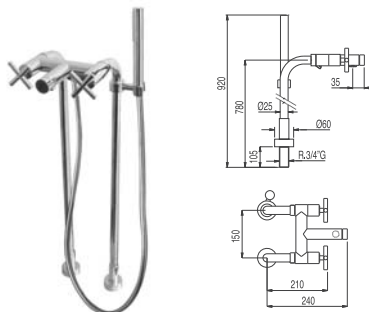

Bath & shower mixer with conections to the floor

Anti-limescale hand shower with directable support. Shower hose satin.

Gruppo vasca con presa a pavimento

Doccetta anticalcare con supporto orientabile. Flessibile satin.

Vanový set s podlahovými přívody

Ruční sprcha s nastavitelným držákem, proti usaz. vod. kamene a flexi hadice SATIN.



163194

619,00

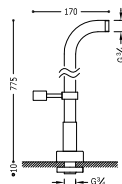

Water intake at floor of bath 2 units with adjustable shower support

Prese d'acqua a terra per vasca da bagno
2 unità con supporto doccia girevole

Vodovodní podlahové přípojky
2 kusy s otočným sprchovým držákem

161194

267,00

BUILT-IN SETS | GRUPPI AD INCASSO | VESTAVĚNÉ SOUPRAVY

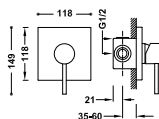

Built-in mixer taps RAPID-BOX (1 way)

Concealed body with buffers. ABS embedding box. Anti-moisture seal.

Monocomando incasso RAPID-BOX (1 via)

Corpo a incasso con smorzatori. Scatola da incasso in ABS. Guarnizione antiumidità.

Vestavěná jednopáková baterie RAPID-BOX (jednocestný)

Podomítkové těleso s tlumiči. Krabice ABS k zabudování do zdi. Těsnění proti vlhkosti.



06227701

102,00

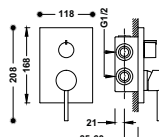

Built-in mixer taps RAPID-BOX (2 way)

Concealed body with buffers. ABS embedding box. Anti-moisture seal.

Monocomando incasso RAPID-BOX (2 vie)

Corpo a incasso con smorzatori. Scatola da incasso in ABS. Guarnizione antiumidità.

Vestavěná jednopáková baterie RAPID-BOX (dvoucestný)

Podomítkové těleso s tlumiči. Krabice ABS k zabudování do zdi. Těsnění proti vlhkosti.



06228001

197,00

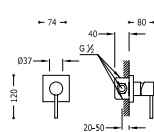

Built-in mixer taps (1 way)

Built-in body included

Monocomando incasso (1 via)

corpo incassato incluso

Vestavěná jednopáková baterie (jednocestný)

včetně podomítkového tělesa



06217702

97,05

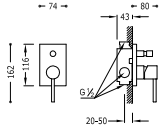

Built-in mixer taps (2 way)

Built-in body included

Monocomando incasso (2 vie)

corpo incassato incluso

Vestavěná jednopáková baterie (dvoucestný)

včetně podomítkového tělesa



06218002

171,00

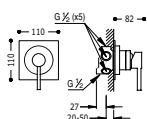

5-way diverter

With water shut off and flow control. Built-in body included.

Distributore 5 vie

Con chiusura e regolazione di portata. Corpo incassato incluso.

Vestavěný pěticestý rozdělovač uzávěrem a regulací průtoku (1 vstup a 5 výstupů). Včetně podomítkového tělesa.



134550

230,00

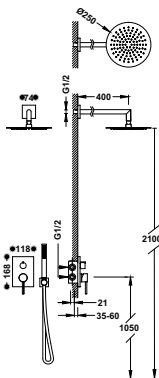

Concealed shower set RAPID-BOX

with water shut off and flow control.

- Built-in body included
- Stainless steel fixed shower head Ø 250 mm. With ball joint.
- Elbow wall.
- Anti-limescale hand shower.
- Shower hose SATIN.

Kit doccia ad incasso RAPID-BOX

Con chiusura e regolazione di portata.

- Corpo incassato incluso
- Doccia fissa acciaio inossidabile Ø 250 mm. con snodo.
- Supporto per doccia.
- Doccetta anticalcare.
- Flessibile satin.

Podomítkový jednopákový sprchový set RAPID-BOX

s uzávěrem a regulací průtoku.

- Včetně podomítkového tělesa
- Pevná sprcha Ø 250 mm. s kloubem. Materiál nerez. oceli.
- Držák s nástěnným přívodem vody
- Ruční sprcha, proti usaz. vod. kamene.
- Flexi hadice SATIN.



06228004

477,00



Concealed shower set

with water shut off and flow control.

- Built-in body included
- Fixed shower head Ø 250 mm. with ball joint. Stainless material.
- Elbow wall.
- Anti-limescale hand shower.
- Satin hose.

Kit doccia ad incasso

Con chiusura e regolazione di portata.

- Corpo incassato incluso
- Doccia fissa Ø 250 mm. con snodo. Materiale acciaio inossidabile.
- Supporto per doccia.
- Doccetta anticalcare.
- Flessibile satin.

Podomítkový jednopákový sprchový set

s uzávěrem a regulací průtoku.

- Včetně podomítkového tělesa
- Pevná sprcha Ø 250 mm. s kloubem. Materiál nerezová ocel.
- Držák s nástěnným přívodem vody.
- Ruční sprcha, proti usaz. vod. kamene.
- Flexi hadice SATIN.



06298004

477,00

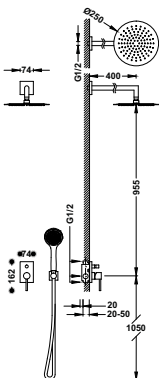

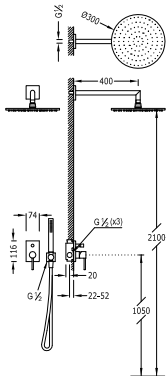

Concealed shower set

with water shut off and flow control.

- Built-in body included
- Fixed shower head \varnothing 300 mm. with ball joint. Brass.
- Elbow wall.
- Anti-limescale hand shower.
- Satin hose.

Kit doccia ad incasso

Con chiusura e regolazione di portata.

- Corpo incassato incluso
- Doccia fissa \varnothing 300 mm. con snodo. Ottone.
- Supporto per doccia.
- Doccetta anticalcare.
- Flessibile satin.

Podomítkový jednopákový sprchový set

s uzávěrem a regulací průtoku.

- Včetně podomítkového tělesa
- Pevná sprcha \varnothing 300 mm. s kloubem. Materiál mosaz.
- Držák s nástěnným přívodem vody.
- Ruční sprcha, proti usaz. vod. kamene.
- Flexi hadice SATIN.



9130190

06298001

496,00

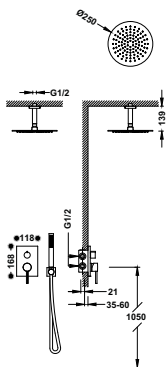

Concealed shower set RAPID-BOX

with water shut off and flow control.

- Built-in body included
- Stainless steel fixed shower head \varnothing 250 mm. with ball joint.
- Elbow wall.
- Anti-limescale hand shower.
- Shower hose SATIN.

Kit doccia ad incasso RAPID-BOX

Con chiusura e regolazione di portata.

- Corpo incassato incluso
- Doccia fissa acciaio inossidabile \varnothing 250 mm. con snodo.
- Supporto per doccia.
- Doccetta anticalcare.
- Flessibile satin.

Podomítkový jednopákový sprchový set RAPID-BOX

s uzávěrem a regulací průtoku.

- Včetně podomítkového tělesa
- Pevná sprcha \varnothing 250 mm. s kloubem. Materiál nerez. oceli.
- Držák s nástěnným přívodem vody.
- Ruční sprcha, proti usaz. vod. kamene.
- Flexi hadice SATIN.



29903507

06228003

457,00

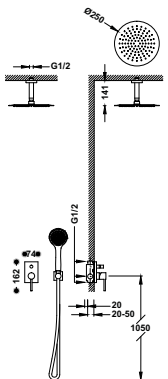

Concealed shower set

with water shut off and flow control.

- Built-in body included
- Fixed shower head \varnothing 250 mm. with ball joint. Stainless material.
- Elbow wall.
- Anti-limescale hand shower.
- Satin hose.

Kit doccia ad incasso

Con chiusura e regolazione di portata.

- Corpo incassato incluso
- Doccia fissa \varnothing 250 mm. con snodo. Materiale acciaio inossidabile.
- Supporto per doccia.
- Doccetta anticalcare.
- Flessibile satin.

Podomítkový jednopákový sprchový set

s uzávěrem a regulací průtoku.

- Včetně podomítkového tělesa
- Pevná sprcha \varnothing 250 mm. s kloubem. Materiál nerezová ocel.
- Držák s nástěnným přívodem vody.
- Ruční sprcha, proti usaz. vod. kamene.
- Flexi hadice SATIN.



9130190

06218081

457,00

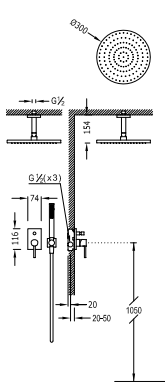

- Concealed shower set**
with water shut off and flow control.
- Built-in body included
 - Fixed shower head \varnothing 300 mm. with ball joint. Brass.
 - Elbow wall.
 - Anti-limescale hand shower.
 - Satin hose.

- Kit doccia ad incasso**
Con chiusura e regolazione di portata.
- Corpo incassato incluso
 - Doccia fissa \varnothing 300 mm. con snodo. Ottone.
 - Supporto per doccia.
 - Doccetta anticalcare.
 - Flessibile satin.

- Podomítkový jednopákový sprchový set*
s uzávěrem a regulací průtoku.
- Včetně podomítkového tělesa
 - Pevná sprcha \varnothing 300 mm. s kloubem. Materiál mosaz.
 - Držák s nástěnným přívodem vody.
 - Ruční sprcha, proti usaz. vod. kamene.
 - Flexi hadice SATIN.



06218080

477,00

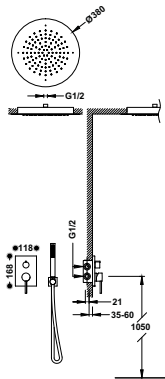

- Concealed shower set RAPID-BOX**
with water shut off and flow control.
- Built-in body included
 - Steel shower head \varnothing 380 mm.
 - Elbow wall.
 - Anti-limescale hand shower.
 - Satin hose.

- Kit doccia ad incasso RAPID-BOX**
Con chiusura e regolazione di portata.
- Corpo incassato incluso
 - Soffione doccia acciaio inossidabile \varnothing 380 mm.
 - Supporto per doccia.
 - Doccetta anticalcare.
 - Flessibile satin.

- Podomítkový jednopákový sprchový set RAPID-BOX*
s uzávěrem a regulací průtoku.
- Včetně podomítkového tělesa
 - Sprchově kropítko z nerez. oceli \varnothing 380 mm.
 - Držák s nástěnným přívodem vody.
 - Ruční sprcha, proti usaz. vod. kamene.
 - Flexi hadice SATIN.



06228005

711,00

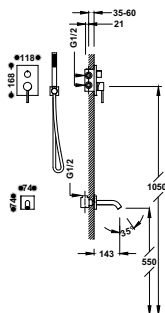

- Concealed shower set RAPID-BOX**
with water shut off and flow control.
- Built-in body included.
 - Bath spout.
 - Elbow wall.
 - Anti-limescale hand shower.
 - Shower hose SATIN.

- Kit doccia ad incasso RAPID-BOX**
Con chiusura e regolazione di portata.
- Corpo incassato incluso.
 - Canna per vasca da bagno.
 - Supporto per doccia.
 - Doccia anticalcare.
 - Flessibile satin.

- Podomítkový jednopákový sprchový set RAPID-BOX*
s uzávěrem a regulací průtoku.
- Včetně podomítkového tělesa.
 - Kahautek pro vanu.
 - Držák s nástěnným přívodem vody.
 - Ruční sprcha, proti usaz. vod. kamene.
 - Flexi hadice SATIN.



06228006

278,00

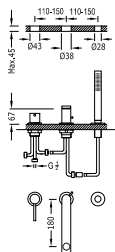

Bath-shower single lever tap for bracket shelf with shower Anti-limescale.

- Flowrate: 3 bar – 16 l/m.
- Compatible with tank kit ref: 20324501.
- Spout 180 mm.

Monocomando bordo vasca

Doccetta anticalcare.

- Portata: 3 bar – 16 l/m.
- Compatibile con il kit serbatoio cod: 20324501.
- Canna 180 mm.

Jednopáková stojánková vanová baterie

Sprcha, proti usaz. vod. kamene.

- Prútok: 3 bar – 16 l/m
- Kompatibilní se sadou nádrže ref. č.: 20324501.
- Ramínko 180 mm.



06216103

344,00

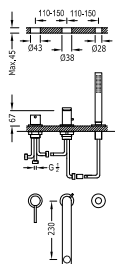

Bath-shower single lever tap for bracket shelf with shower Anti-limescale.

- Flowrate: 3 bar – 16 l/m.
- Compatible with tank kit ref: 20324501.
- Spout 230 mm.

Monocomando bordo vasca

Doccetta anticalcare.

- Portata: 3 bar – 16 l/m.
- Compatibile con il kit serbatoio cod: 20324501.
- Canna 230 mm.

Jednopáková stojánková vanová baterie

Sprcha, proti usaz. vod. kamene.

- Prútok: 3 bar – 16 l/m
- Kompatibilní se sadou nádrže ref. č.: 20324501.
- Ramínko 230 mm.



06216102

355,00



Bath-shower kit cistern

Kit bordo vasca

Set nádrže pro stojánkové vanové baterie

(per ref. / for Nr. / Kód: 06216103, 06216102, 20016203, 20016201, 08116104, 08116103, 20316102, 20316101).

20324501

381,00



Bath valve with drainage point

Valvola vasca con presa drenaggio

Vanový odpadový ventil

134445

86,00

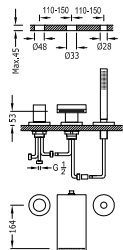

Bath-shower single lever tap for bracket shelf with cascade cast spout and Anti-limescale hand shower.
 · Flowrate: 3 bar – 17 l/m.
 · Compatible with tank kit ref. 162245.

Monocomando bordo vasca
 Con bocca a cascata, doccetta anticalcare.
 · Portata: 3 bar – 17 l/m.
 · Compatibile con il kit serbatoio cod: 162245.

Jednopáková stojánková vanová baterie s ramínkem kaskádou. Sprcha, proti usaz. vod. kamene.
 · Průtok: 3 bar – 17 l/m
 · Kompatibilní se sadou nádrže ref. č.: 162245.



06116101

725,00

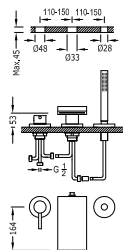

Bath-shower single lever tap for bracket shelf with cascade cast spout and Anti-limescale hand shower.
 · Flowrate: 3 bar – 17 l/m.
 · Compatible with tank kit ref. 162245.

Monocomando bordo vasca
 Con bocca a cascata, doccetta anticalcare.
 · Portata: 3 bar – 17 l/m.
 · Compatibile con il kit serbatoio cod: 162245.

Jednopáková stojánková vanová baterie s ramínkem kaskádou. Sprcha, proti usaz. vod. kamene.
 · Průtok: 3 bar – 17 l/m
 · Kompatibilní se sadou nádrže ref. č.: 162245.



162161

725,00



Bath-shower kit cistern

Kit bordo vasca

Set nádrže pro stojánkové vanové baterie

(per ref. / for Nr. / Kód: 06116101, 162161, 26115001, 26215001.).

162245

381,00



Bath valve with drainage point

Valvola vasca con presa drenaggio

Vanový odpadový ventil

134445

86,00



Bath-shower single lever tap for bracket shelf

- Anti-limescale hand shower.
- Flowrate: 3 bar – 17 l/m.
- Compatible with tank kit ref: 134345.

Batteria bordo vasca

- Doccetta anticalcare.
- Portata: 3 bar – 17 l/m.
- Compatibile con il kit serbatoio cod: 134345.

Stojánková vanová baterie

- Ruční sprcha, proti usaz. vod. kamene.
- Průtok: 3 bar – 17 l/m
- Kompatibilní se sadou nádrže ref. č.: 134345.



163145

518,00

Bath-shower kit cistern**Kit bordo vasca**

Set nádrže pro stojánkové vanové baterie
(per ref. / for Nr. / Kód: 163145, 132145, 124146.)



134345

396,00

Bath valve with drainage point

Valvola vasca con presa drenaggio
Vanový odpadový ventil



134445

86,00

THERMOSTATICALLY-CONTROLLED | TERMOSTATICHE | TERMOSTATICKÉ**Wall thermostatic shower mixer****Doccia termostatica**

Termostatická sprchová baterie

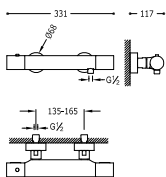

06116201

219,00

Wall thermostatic shower mixer

(Anti-limescale hand shower with directable support and satin hose).

Doccia termostatica

(Doccetta anticalcare con supporto orientabile. Flessibile satin).

Termostatická sprchová baterie

(Ruční sprcha s nastavitelným držákem, proti usaz. vod. kamene a flexi hadice SATIN).

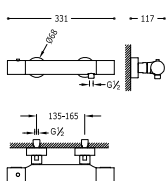

06116209

268,00



Wall thermostatic shower mixer with cascade. Diverter integrated in the flow control.

Vasca-Doccia termostatica con cascata. Invertitore integrato nel regolatore di portata.

Termostatická baterie pro vanu-sprchu s kaskádou. Prepínač zabudovaný v regulaci průtoku.

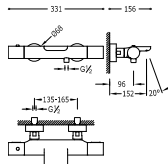

06117201

280,00

Wall thermostatic shower mixer with cascade (Anti-limescale hand shower with directable support. Shower hose satin). Diverter integrated in the flow control.

Vasca-Doccia termostatica Con bocca a cascata (Doccetta anticalcare con supporto orientabile. Flessibile satin). Invertitore integrato nel regolatore di portata.

Termostatická baterie pro vanu-sprchu s kaskádou (Ruční sprcha s nastavitelným držákem, proti usaz. vod. kamene a flexi hadice SATIN). Prepínač zabudovaný v regulaci průtoku.

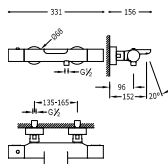

06117209

329,00

Wall thermostatic shower mixer

Doccia termostatica
Termostatická sprchová baterie

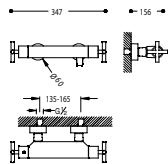

06316201

276,00

Wall thermostatic shower mixer (Anti-limescale hand shower with directable support. Shower hose satin).

Doccia termostatica (Doccetta anticalcare con supporto orientabile. Flessibile satin).

Termostatická sprchová baterie (Ruční sprcha s nastavitelným držákem, proti usaz. vod. kamene a flexi hadice SATIN).

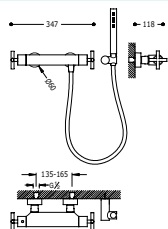

06316209

331,00

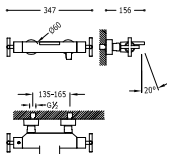

Wall thermostatic shower mixer with cascade. Diverter integrated in the flow control.

Vasca-Doccia termostatica con cascata. Invertitore integrato nel regolatore di portata.

Termostatická baterie pro vanu-sprchu s kaskádou. Přepínač zabudovaný v regulaci průtoku.



29916301

06317201

363,00

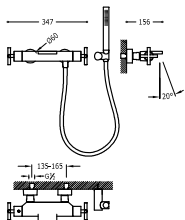

Wall thermostatic shower mixer with cascade (Anti-limescale hand shower with directable support. Shower hose satin). Diverter integrated in the flow control.

Vasca-Doccia termostatica con bocca a cascata (Doccetta anticalcare con supporto orientabile. Flessibile satin). Invertitore integrato nel regolatore di portata.

Termostatická baterie pro vanu-sprchu s kaskádou (Ruční sprcha s nastavitelným držákem, proti usaz. vod. kamene a flexi hadice SATIN). Přepínač zabudovaný v regulaci průtoku.



29916301

06317209

416,00

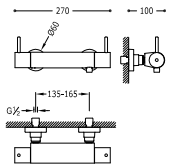

Wall thermostatic shower mixer Suitable for persons with physical disabilities.

Doccia termostatica Indicato per persone con disabilità fisiche

Termostatická sprchová baterie Určeno pro osoby s fyzickým handicapem



29919509

09026401

198,00

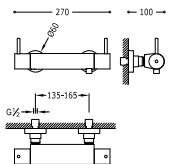

Wall thermostatic shower mixer Anti-limescale hand shower with directable support. Shower hose satin. Suitable for persons with physical disabilities.

Doccia termostatica Doccetta anticalcare con supporto orientabile. Flessibile satin. Indicato per persone con disabilità fisiche

Termostatická sprchová baterie Ruční sprcha s nastavitelným držákem (299.631.03), proti usaz. vod. kamene a flexi hadice SATIN). Určeno pro osoby s fyzickým handicapem



29919509

09096401

230,00

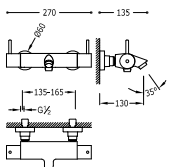

Wall thermostatic shower mixer Suitable for persons with physical disabilities. Diverter integrated in the flow control.

Vasca-Doccia termostatica Indicato per persone con disabilità fisiche. Invertitore integrato nel regolatore di portata.

Termostatická baterie pro vanu-sprchu Určeno pro osoby s fyzickým handicapem. Přepínač zabudovaný v regulaci průtoku.



29919509

09027401

250,00

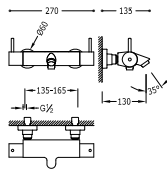

Wall thermostatic shower mixer

Anti-limescale hand shower with directable support. Shower hose satin. Suitable for persons with physical disabilities. Diverter integrated in the flow control.

Vasca-Doccia termostatica

Doccetta anticalcare con supporto orientabile. Flessibile satin. Indicato per persone con disabilità fisiche. Invertitore integrato nel regolatore di portata.

Termostatická baterie pro vanu-sprchu

Ruční sprcha s nastavitelným držákem, proti usaz. vod. kamene a flexi hadice SATIN. Určeno pro osoby s fyzickým handicapem. Přepínač zabudovaný v regulaci průtoku.



09097401

284,00

THERMOSTATICALLY-CONTROLLED SETS | GRUPPI TERMOSTATICI | TERMOSTATICKÉ SOUPRAVY (COMPACT)

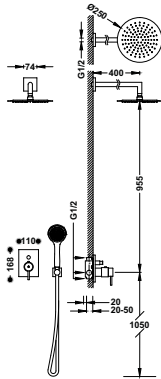

Concealed thermostatic shower kit with water shut off and flow control (2 ways).

- Built-in body included
- Fixed shower head Ø 250 mm. with ball joint. Stainless material.
- Elbow wall.
- Anti-limescale hand shower.
- Satin hose.

Kit termostatico doccia ad incasso

Con chiusura e regolazione di portata (2 vie).

- Corpo incassato incluso
- Doccia fissa Ø 250 mm. con snodo. Materiale acciaio inossidabile.
- Supporto per doccia.
- Doccetta anticalcare.
- Flessibile satin.

Podmítkový sprchový set termostatické bateri

s uzavěrem a regulací průtoku (2-cestná).

- Včetně podmítkového tělesa
- Pevná sprcha Ø 250 mm. s kloubem. Materiál nerezová ocel.
- Držák s nástěnným přívodem vody.
- Ruční sprcha, proti usaz. vod. kamene.
- Flexi hadice SATIN.



09096023

560,00

SHUTOFF VALVES | RUBINETTI DI ARRESTO | PRŮCHOZÍ VENTILY

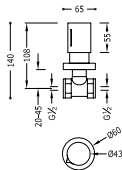

1/2" threaded-ends gate-valve

Rubinetto di arresto filettato 1/2"

Uzavírací ventil 1/2"

06115501

74,70

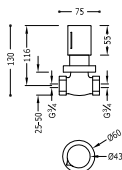

3/4" threaded-ends gate-valve

Rubinetto di arresto filettato 3/4"

Uzavírací ventil 3/4"

06151101

82,90

464 / **Basin mixer taps** | Lavabi | Koupelnová baterie468 / **Bidets** | Bidet | Bidety470 / **Bathtub mixer taps** | Monocomando esterno | Jednopákový mechanismus vany470 / **Built-in sets** | Monocomando ad incasso | Vestavěné soupravy473 / **Deck-mounted bathtubs** | Bordovasca | Vany s prodlouženým pultem474 / **Thermostatically-controlled** | Termostatica | Termostatické475 / **Shutoff valves** | Rubinetti di arresto | Průchozí ventily

LOFT-TRES



www.qtr.es/loft-tres

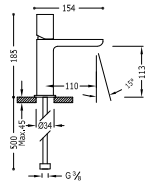

Chrome
Cromato
Chrom

**Single lever washbasin mixer****Monocomando lavabo***Jednopáková umyvadlová baterie*

9130190

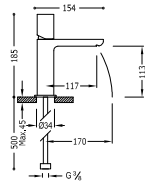
20010302 **115,00**20010302D **138,00****Single lever washbasin mixer****with cascade cast spout. * NOTE: Taps with a cascade spout come with 2 regulation valves and a filter (Nr.: 9134525)****Monocomando lavabo****con bocca a cascata. * NOTA: La rubinetteria con canna a cascata è accompagnata da 2 rubinetti di regolazione con filtro (Ref: 9134525)***Jednopáková umyvadlová baterie**ramínko s vodopádem. * POZNÁMKA: Baterie typu vodopádu je doplněna dvěma regulačními kohouty s filtrem (Kód: 9134525)*

9130190

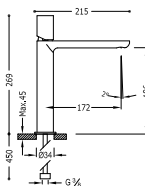
20010102 **137,00**20010102D **162,00****Single lever washbasin mixer****Monocomando lavabo***Jednopáková umyvadlová baterie*

9130190

20020304 **208,00**

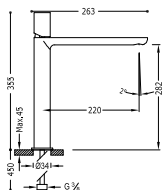

Single lever washbasin mixer
Monocomando lavabo
Jednárková umyvadlová baterie



20020306

231,00

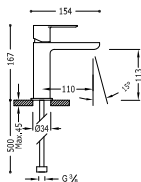

Single lever washbasin mixer
Monocomando lavabo
Jednárková umyvadlová baterie



20010301

115,00

20010301D

138,00

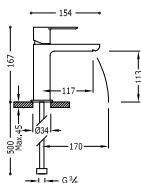

Single lever washbasin mixer
with cascade cast spout. * NOTE: Taps with a cascade spout come with 2 regulation valves and a filter (Nr.: 9134525)

Monocomando lavabo
 con bocca a cascata. * NOTA: La rubinetteria con canna a cascata è accompagnata da 2 rubinetti di regolazione con filtro (Ref: 9134525)

Jednárková umyvadlová baterie
 ramínko s vodopádem. * POZNÁMKA: Baterie typu vodopádu je doplněna dvěma regulačními kohouty s filtrem (Kód: 9134525)



20010101

137,00

20010101D

162,00

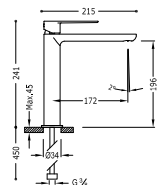

Single lever washbasin mixer
with base extension

Monocomando lavabo
 con prolunga inferiore
Jednárková umyvadlová baterie
 s nástavcem



20020303

208,00

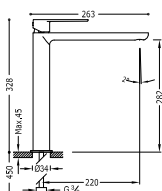

Single lever washbasin mixer
with base extension

Monocomando lavabo
 con prolunga inferiore
Jednárková umyvadlová baterie
 s nástavcem



20020305

231,00

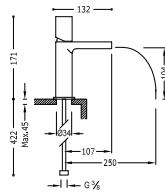
**Single lever washbasin mixer**

with open cascade spout. NOTE: Taps with a cascade spout come with 2 regulation valves and a filter (Nr.: 9134525)

Monocomando lavabo

con bocca a cascata aperta. NOTA: La rubinetteria con canna a cascata è accompagnata da 2 rubinetti di regolazione con filtro (Ref: 9134525)

Jednopáková umyvadlová baterie

ramínko s otvoreným vodopádem. POZNÁMKA: Baterie typu vodopádu je doplněna dvěma regulačními kohouty s filtrem (Kód: 9134525)



9130190

20011002

194,00

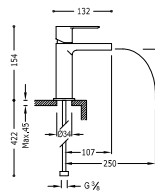
**Single lever washbasin mixer**

with open cascade spout. NOTE: Taps with a cascade spout come with 2 regulation valves and a filter (Nr.: 9134525)

Monocomando lavabo

con bocca a cascata aperta. NOTA: La rubinetteria con canna a cascata è accompagnata da 2 rubinetti di regolazione con filtro (Ref: 9134525)

Jednopáková umyvadlová baterie

ramínko s otvoreným vodopádem. POZNÁMKA: Baterie typu vodopádu je doplněna dvěma regulačními kohouty s filtrem (Kód: 9134525)



9130190

20011001

194,00



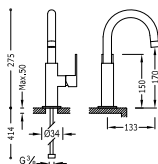

Single lever washbasin mixer
Monocomando lavabo
Jednopáková umyvadlová baterie



20020504

165,00

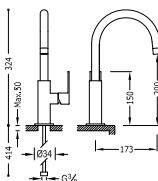

Single lever washbasin mixer
Monocomando lavabo
Jednopáková umyvadlová baterie



20020505

171,00

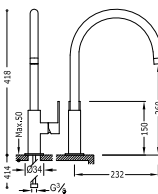

Single lever washbasin mixer
Monocomando lavabo
Jednopáková umyvadlová baterie



20020506

176,00

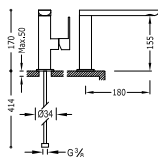

Single lever washbasin mixer
spout 35x15 mm.

Monocomando lavabo
canna 35x15 mm.
Jednopáková umyvadlová baterie
ramínko 35x15 mm



20020501

171,00

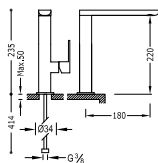

Single lever washbasin mixer
spout 35x15 mm.

Monocomando lavabo
canna 35x15 mm.
Jednopáková umyvadlová baterie
ramínko 35x15 mm



20020502

189,00

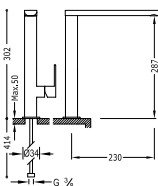

Single lever washbasin mixer
spout 35x15 mm.

Monocomando lavabo
canna 35x15 mm.
Jednopáková umyvadlová baterie
ramínko 35x15 mm



20020503

225,00

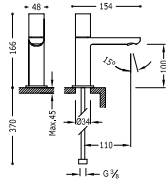
**1 water or premixed bathroom tap****Rubinetto lavandino 1 acqua o premiscelata**

Umyvadlová baterie pro jednu nebo předem smíchanou vodu



9134282

20050301

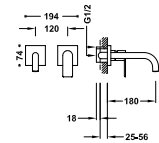
104,00**Single lever wall washbasin mixer****Indivisible concealed body with buffers. Anti-moisture seal. Spout 180 mm.****Monomando a muro**

Corpo a incasso indivisibile con smorzatori. Guarnizione antiumidità. Canna 180 mm.

*Jednopáková nástěnná baterie**Podomítkové těleso v nedělitelném provedení s tlumiči. Těsnění proti vlhkosti. Ramínko 180 mm.*

29902801

20030001

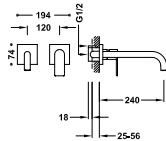
204,00**Single lever wall washbasin mixer****Indivisible concealed body with buffers. Anti-moisture seal. Spout 240 mm.****Monomando a muro**

Corpo a incasso indivisibile con smorzatori. Guarnizione antiumidità. Canna 240 mm.

*Jednopáková nástěnná baterie**Podomítkové těleso v nedělitelném provedení s tlumiči. Těsnění proti vlhkosti. Ramínko 240 mm.*

29902801

20030002

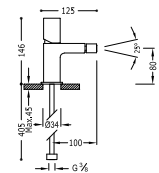
225,00**BIDETS | BIDET | BIDEŤY****Single lever bidet mixer****Monocomando bidet***Jednopáková bidetová baterie*

9130190

20012002

117,00

20012002D

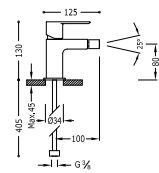
140,00**Single lever bidet mixer****Monocomando bidet***Jednopáková bidetová baterie*

9130190

20012001

117,00

20012001D

140,00

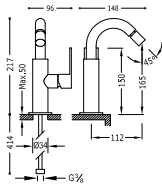

Single lever bidet mixer
Monocomando bidet
Jednápáková bidetová baterie



20022401

158,00

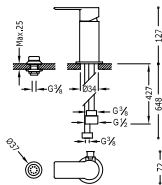

Bidet mixer tap with small shower head
Monocomando bidet con doccetta
Jednápáková bidetová baterie se sprškou



20013001

121,00

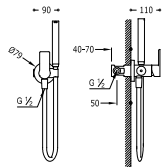

Concealed single lever bidet/toilets
Left or right support, interchangeable. Sateen hose.

Monocomando ad incasso per bidè WC
Supporto a destra o a sinistra, intercambiabile. Flesso satinato.

Jednápáková podomítková baterie pro bidet WC
Vyměnitelný držák zprava či zleva. Sprchová mosazná baterie s
omezovacím hrdlem 5 l/m. Systém proti kapání a flexi hadice SATIN



20522301

158,00

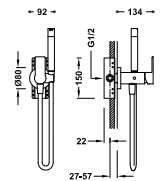

Concealed single lever bidet/toilets
Left or right support, interchangeable. Sateen hose. Optie gips

Monocomando ad incasso per bidè WC
Supporto a destra o a sinistra, intercambiabile. Flesso satinato. Opzione Cartongesso

Jednápáková podomítková baterie pro bidet WC
Vyměnitelný držák zprava či zleva. Sprchová mosazná baterie s
omezovacím hrdlem 5 l/m. Systém proti kapání a flexi hadice
SATIN. Možnost pro sádrokartonové panely



20522201

195,00



Accessory towel racks

180 mm. (for Nr.: 134122, 134123, 181122, 181123, 181222, 181223, 20522201, 20522301). NOTE: Left or right support, interchangeable.

Accessori portasciugamani

180 mm. (per ref.: 134122, 134123, 181122, 181123, 181222, 181223, 20522201, 20522301). NOTA: Supporto a destra o a sinistra, intercambiabile.

Príslušenství držák na ručníky

180 mm. (Kód: 134122, 134123, 181122, 181123, 181222, 181223, 20522201, 20522301). POZNÁMKA: Právý nebo levý podstavec, vyměnitelný.



03412401

32,00

BATHTUB MIXER TAPS | MONOCOMANDI BAGNO | JEDNOPÁKOVÝ MECHANISMUS VANY

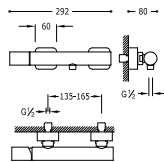
**Single lever shower mixer**

Anti-limescale hand shower with directable support. Shower hose satin.

Monocomando doccia

Doccetta anticalcare con supporto orientabile. Flessibile satin.

Jednopaková sprchová baterie

Ruční sprcha s nastavitelným držákem, proti usaz. vod. kamene a flexi hadice SATIN.



20016701

206,00

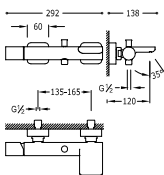
**Single lever bath and shower mixer**

with cascade. Anti-limescale hand shower with directable support. Shower hose satin.

Monocomando vasca

Con bocca a cascata. Doccetta anticalcare con supporto orientabile. Flessibile satin.

Jednopaková baterie pro vanu-sprchu

s kaskádou. Ruční sprcha s nastavitelným držákem, proti usaz. vod. kamene a flexi hadice SATIN.



20017001

239,00

BUILT-IN SETS | GRUPPI AD INCASSO | VESTAVĚNÉ SOUPRAVY

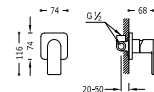
**Single lever bath and shower mixer**

with cascade. Anti-limescale hand shower with directable support. Shower hose satin.

Monocomando vasca

Con bocca a cascata. Doccetta anticalcare con supporto orientabile. Flessibile satin.

Jednopaková baterie pro vanu-sprchu

s kaskádou. Ruční sprcha s nastavitelným držákem, proti usaz. vod. kamene a flexi hadice SATIN.



20017701

97,60

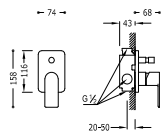
**Built-in mixer taps (2 way)****Built-in body included****Monocomando incasso (2 vie)**

corpo incassato incluso

Vestavěná jednopaková baterie (dvoucestrný)

včetně podomítkového tělesa



20018001

171,00

**Extension for built-in bathtub-shower mixer tap**

Prolunga per monocomando incasso bagno-doccia

Nástavec pro vestavěnou jednopakovou vanu/sprchu

20018010

85,35

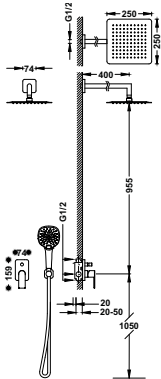

Concealed shower set

with water shut off and flow control.

- Built-in body included
- Fixed shower head 250x250 mm. with ball joint. Stainless material.
- Elbow wall.
- Anti-limescale hand shower (3 fonctions)
- Satin hose.

Kit doccia ad incasso

Con chiusura e regolazione di portata.

- Corpo incassato incluso
- Doccia fissa 250x250 mm. con snodo. Materiale acciaio inossidabile.
- Supporto per doccia.
- Doccetta anticalcare (3 funzioni).
- Flessibile satin.

Podomítkový jednopákový sprchový set

s uzávěrem a regulací průtoku.

- Včetně podomítkového tělesa
- Pevná sprcha 250x250 mm. s kloubem. Materiál nerezová ocel.
- Držák s nástěnným přívodem vody.
- Ruční sprcha (3 funkce) proti usaz. vod. Kamene
- Flexi hadice SATIN.



20018011

419,00

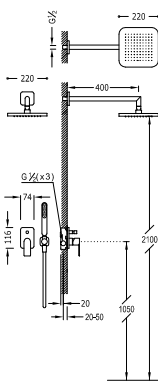

Concealed shower set

with water shut off and flow control.

- Built-in body included
- Fixed shower head 220x220 mm. with ball joint.
- Elbow wall.
- Anti-limescale hand shower.
- Satin hose.

Kit doccia ad incasso

Con chiusura e regolazione di portata.

- Corpo incassato incluso
- Doccia fissa 220x220 mm. con snodo.
- Supporto per doccia.
- Doccetta anticalcare.
- Flessibile satin.

Podomítkový jednopákový sprchový set

s uzávěrem a regulací průtoku.

- Včetně podomítkového tělesa
- Pevná sprcha 220x220 mm. s kloubem.
- Držák s nástěnným přívodem vody.
- Ruční sprcha, proti usaz. vod. Kamene.
- Flexi hadice SATIN.



20018002

419,00

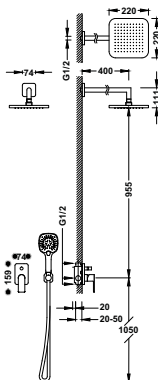

Concealed shower set

with water shut off and flow control.

- Built-in body included
- Fixed shower head 220x220 mm. with ball joint.
- Elbow wall.
- Anti-limescale hand shower.
- Satin hose.

Kit doccia ad incasso

Con chiusura e regolazione di portata.

- Corpo incassato incluso
- Doccia fissa 220x220 mm. con snodo.
- Supporto per doccia.
- Doccetta anticalcare.
- Flessibile satin.

Podomítkový jednopákový sprchový set

s uzávěrem a regulací průtoku.

- Včetně podomítkového tělesa
- Pevná sprcha 220x220 mm. s kloubem.
- Držák s nástěnným přívodem vody.
- Ruční sprcha, proti usaz. vod. Kamene.
- Flexi hadice SATIN.



20018007

419,00

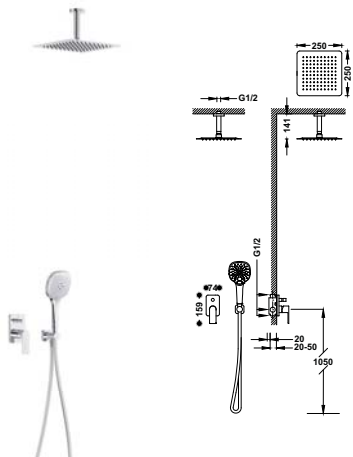
**Concealed shower set**

with water shut off and flow control.

- Built-in body included
- Fixed shower head 250x250 mm. with ball joint. Stainless material.
- Elbow wall.
- Anti-limescale hand shower (3 fonctions)
- Satin hose.

Kit doccia ad incasso

Con chiusura e regolazione di portata.

- Corpo incassato incluso
- Doccia fissa 250x250 mm. con snodo. Materiale acciaio inossidabile.
- Supporto per doccia.
- Doccetta anticalcare (3 funzioni).
- Flessibile satin.

Podomítkový jednopákový sprchový set

s uzávěrem a regulací průtoku.

- Včetně podomítkového tělesa
- Pevná sprcha 250x250 mm. s kloubem. Materiál nerezová ocel.
- Držák s nástěnným přívodem vody.
- Ruční sprcha (3 funkce) proti usaz. vod. Kamene
- Flexi hadice SATIN.



20018009

399,00

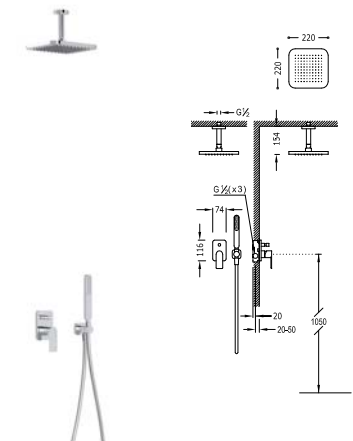
**Concealed shower set**

with water shut off and flow control.

- Built-in body included
- Fixed shower head 220x220 mm. with ball joint.
- Elbow wall.
- Anti-limescale hand shower.
- Satin hose.

Kit doccia ad incasso

Con chiusura e regolazione di portata.

- Corpo incassato incluso
- Doccia fissa 220x220 mm. con snodo.
- Supporto per doccia.
- Doccetta anticalcare.
- Flessibile satin.

Podomítkový jednopákový sprchový set

s uzávěrem a regulací průtoku.

- Včetně podomítkového tělesa
- Pevná sprcha 220x220 mm. s kloubem.
- Držák s nástěnným přívodem vody.
- Ruční sprcha, proti usaz. vod. Kamene.
- Flexi hadice SATIN.



20018080

399,00

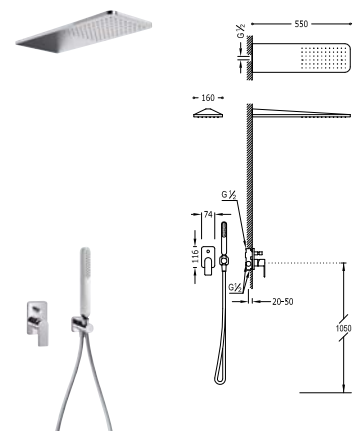
**Concealed shower set**

with water shut off and flow control.

- Built-in body included
- Stainless steel wall shower 160x550 mm.
- Elbow wall.
- Anti-limescale hand shower.
- Satin hose.

Kit doccia ad incasso

Con chiusura e regolazione di portata.

- Corpo incassato incluso
- Doccia acciaio inossidabile da parete 160x550 mm.
- Supporto per doccia.
- Doccetta anticalcare.
- Flessibile satin.

Podomítkový jednopákový sprchový set

s uzávěrem a regulací průtoku.

- Včetně podomítkového tělesa
- Nástěnné sprchové hlavičkové z nerez. oceli 160x550 mm.
- Držák s nástěnným přívodem vody.
- Ruční sprcha, proti usaz. vod. Kamene.
- Flexi hadice SATIN.



20018005

672,00



Bath-shower single lever tap for bracket shelf with shower Anti-limescale.

- Flowrate: 3 bar – 16 l/m.
- Compatible with tank kit ref: 20324501.
- Spout 180 mm.

Monocomando bordo vasca

- con doccetta anticalcare.
- Portata: 3 bar – 16 l/m.
 - Compatibile con il kit serbatoio cod: 20324501.
 - Canna 180 mm.

Jednopávková stojánková vanová baterie

- Sprcha, proti usaz. vod. kamene.
- Průtok: 3 bar – 16 l/m
 - Kompatibilní se sadou nádrže ref. č.: 20324501.
 - Rámčko 180 mm.



20016203

356,00

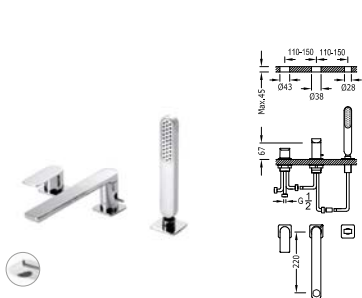

Bath-shower single lever tap for bracket shelf with shower Anti-limescale.

- Flowrate: 3 bar – 16 l/m.
- Compatible with tank kit ref: 20324501.
- Spout 220 mm.

Monocomando bordo vasca

- con doccetta anticalcare.
- Portata: 3 bar – 16 l/m.
 - Compatibile con il kit serbatoio cod: 20324501.
 - Canna 220 mm.

Jednopávková stojánková vanová baterie

- Sprcha, proti usaz. vod. kamene.
- Průtok: 3 bar – 16 l/m
 - Kompatibilní se sadou nádrže ref. č.: 20324501.
 - Rámčko 220 mm.



20016201

381,00

Bath-shower kit cistern
Kit bordo vasca
Set nádrže pro stojánkovou vanovou baterie
(per ref. / for Nr. / Kód: 06216103, 06216102, 20016203, 20016201, 08116104, 08116103, 20316102, 20316101).

20324501 381,00



Bath valve with drainage point
Valvola vasca con presa drenaggio
Vanový odpadový ventil

134445

86,00



Wall thermostatic shower mixer

Doccia termostatica

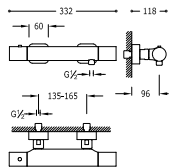
Termostatická sprchová baterie

29919503

20016401

219,00

Wall thermostatic shower mixer**(Anti-limescale hand shower with directable support. Shower hose satin).**

Doccia termostatica

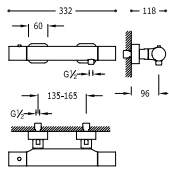
*(Doccetta anticalcare con supporto orientabile. Flessibile satin).**Termostatická sprchová baterie**(Ruční sprcha s nastavitelným držákem, proti usaz. vod. kamene a flexi hadice SATIN).*

29919503

20016409

268,00

Wall thermostatic shower mixer**with cascade. Diverter integrated in the flow control.**

Vasca-Doccia termostatica

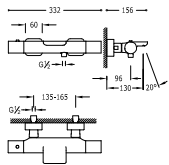
*con cascata. Invertitore integrato nel regolatore di portata.**Termostatická baterie pro vanu-sprchu**s kaskádou. Přepínač zabudovaný v regulaci průtoku.*

29919503

20017401

280,00

Wall thermostatic bath and shower mixer**with cascade (Anti-limescale hand shower with directable support. Shower hose satin). Diverter integrated in the flow control.**

Bagno doccia termostatica

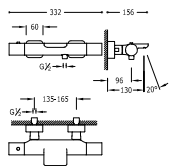
*Con bocca a cascata (Doccetta anticalcare con supporto orientabile. Flessibile satin). Invertitore integrato nel regolatore di portata.**Termostatická baterie pro vanu-sprchu**s kaskádou (Ruční sprcha s nastavitelným držákem, proti usaz. vod. kamene a flexi hadice SATIN). Přepínač zabudovaný v regulaci průtoku.*

29919503

20017409

337,00

Wall thermostatic shower mixer**Suitable for persons with physical disabilities.**

Doccia termostatica

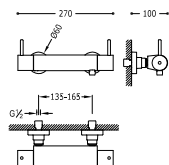
*Indicato per persone con disabilità fisiche**Termostatická sprchová baterie**Určeno pro osoby s fyzickým handicapem*

29919509

09026401

198,00

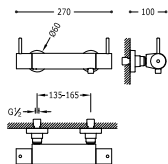

Wall thermostatic shower mixer
 Anti-limescale hand shower with directable support. Shower hose satin. Suitable for persons with physical disabilities.

Doccia termostatica
 Doccetta anticalcare con supporto orientabile. Flessibile satin. Indicato per persone con disabilità fisiche

Termostatická sprchová baterie
 Ruční sprcha s nastavitelným držákem, proti usaz. vod. kamene a flexi hadice SATIN). Určeno pro osoby s fyzickým handicapem



09096401

230,00

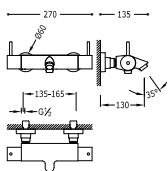

Wall thermostatic shower mixer
 Suitable for persons with physical disabilities.

Vasca-Doccia termostatica
 Indicato per persone con disabilità fisiche

Termostatická baterie pro vanu-sprchu
 Určeno pro osoby s fyzickým handicapem



09027401

250,00

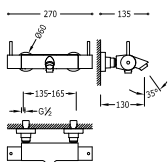

Wall thermostatic shower mixer
 Anti-limescale hand shower with directable support. Shower hose satin. Suitable for persons with physical disabilities.

Vasca-Doccia termostatica
 Doccetta anticalcare con supporto orientabile. Flessibile satin. Indicato per persone con disabilità fisiche

Termostatická baterie pro vanu-sprchu
 Ruční sprcha s nastavitelným držákem, proti usaz. vod. kamene a flexi hadice SATIN). Určeno pro osoby s fyzickým handicapem



09097401

284,00

SHUTOFF VALVES | RUBINETTI DI ARRESTO | PRŮCHOZÍ VENTILY

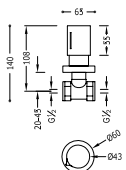

1/2" threaded-ends gate-valve
 Rubinetto di arresto filettato 1/2"
 Uzavírací ventil 1/2"

06115501

74,70

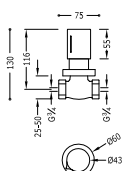

3/4" threaded-ends gate-valve
 Rubinetto di arresto filettato 3/4"
 Uzavírací ventil 3/4"

06151101

82,90

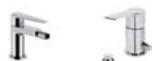
478 / **Basin mixer taps** | Lavabi | Koupelnová baterie480 / **Bidets** | Bidet | Bidety480 / **Bathtub mixer taps** | Monocomando esterno | Jednopákový mechanismus vany481 / **Built-in sets** | Monocomando ad incasso | Vestavěné soupravy486 / **Deck-mounted bathtubs** | Bordovasca | Vany s prodlouženým pultem487 / **Thermostatically-controlled** | Termostatica | Termostatické

TRES

CLASS-TRES



www.qtr.es/class-tres



Chrome
Cromato
Chrom

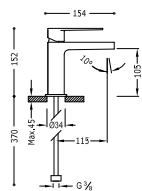

Single lever washbasin mixer
Monocomando lavabo
Jednopáková umyvadlová baterie



9130190

■ 20510301 **92,60**

■ 20510301D **109,00**

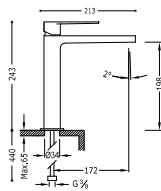

Single lever washbasin mixer
Monocomando lavabo
Jednopáková umyvadlová baterie



9130190

■ 20510303 **200,00**

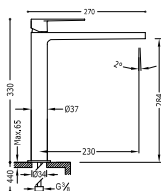

Single lever washbasin mixer
Monocomando lavabo
Jednopáková umyvadlová baterie



9130190

■ 20510305 **221,00**



Single lever wall washbasin mixer
Indivisible concealed body with buffers. Anti-moisture seal. Spout 180 mm.

Monomando a muro
 Corpo a incasso indivisibile con smorzatori. Guarnizione antiumidità. Canna 180 mm.

Jednopáková nástěnná baterie
Podomítkové těleso v nedělitelném provedení s tlumiči. Těsnění proti vlhkosti. Ramínko 180 mm.



20530011

204,00

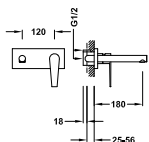

Single lever wall washbasin mixer
Indivisible concealed body with buffers. Anti-moisture seal. Spout 240 mm.

Monomando a muro
 Corpo a incasso indivisibile con smorzatori. Guarnizione antiumidità. Canna 240 mm.

Jednopáková nástěnná baterie
Podomítkové těleso v nedělitelném provedení s tlumiči. Těsnění proti vlhkosti. Ramínko 240 mm.



20530012

226,00

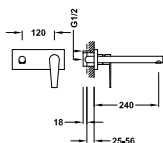

Single lever wall washbasin mixer
Indivisible concealed body with buffers. Anti-moisture seal. Spout 177 mm.

Monomando a muro
 Corpo a incasso indivisibile con smorzatori. Guarnizione antiumidità. Canna 177 mm.

Jednopáková nástěnná baterie
Podomítkové těleso v nedělitelném provedení s tlumiči. Těsnění proti vlhkosti. Ramínko 177 mm.



20530001

185,00

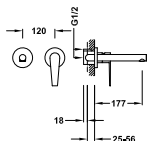

Single lever wall washbasin mixer
Indivisible concealed body with buffers. Anti-moisture seal. Spout 237 mm.

Monomando a muro
 Corpo a incasso indivisibile con smorzatori. Guarnizione antiumidità. Canna 237 mm.

Jednopáková nástěnná baterie
Podomítkové těleso v nedělitelném provedení s tlumiči. Těsnění proti vlhkosti. Ramínko 237 mm.



20530002

196,00

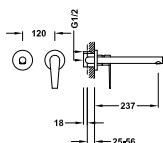

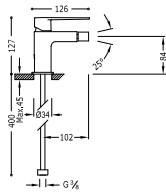

Single lever bidet mixer
Monocomando bidet
Jednopáková bidetová baterie

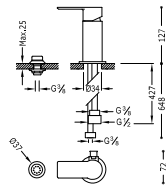

9130190

20512001 **92,60**20512001D **109,00**

Bidet mixer tap with small shower head
Monocomando bidet con doccia
Jednopáková bidetová baterie se sprškou



9134592

20013001 **121,00**

BATHTUB MIXER TAPS | MONOCOMANDI BAGNO | JEDNOPÁKOVÝ MECHANISMUS VANY

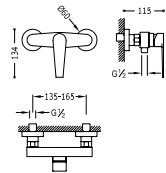

Single lever shower mixer
Anti-limescale hand shower with directable support. Shower hose satin.

Monocomando doccia
Doccetta anticalcare con supporto orientabile. Flessibile satin.

Jednopáková sprchová baterie
Ruční sprcha s nastavitelným držákem, proti usaz. vod. kamene a flexi hadice SATIN.

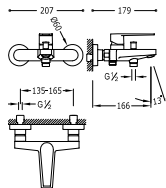

910719005

20516701 **116,00**

Single lever bath and shower mixer
Anti-limescale hand shower with directable support. Shower hose satin.

Monocomando vasca
Doccetta anticalcare con supporto orientabile. Flessibile satin.

Vanová baterie
Ruční sprcha s nastavitelným držákem, proti usaz. vod. kamene a flexi hadice SATIN.



9130190

20517001 **135,00**

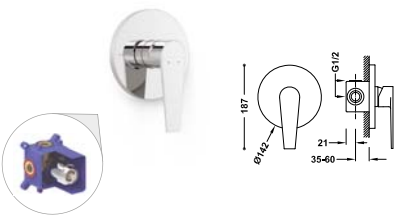

Built-in mixer taps RAPID-BOX (1 way)
 Concealed body with buffers. ABS embedding box. Anti-moisture seal.

Monocomando incasso RAPID-BOX (1 via)
 Corpo a incasso con smorzatori. Scatola da incasso in ABS. Guarnizione antiumidità.

Vestavěná jednopáková baterie RAPID-BOX (jednocestná)
Podomítkové těleso s tlumiči. Krabice ABS k zabudování do zdi.
Těsnění proti vlhkosti.



20527701

76,15

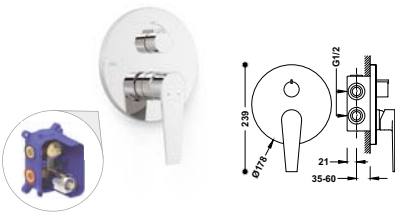

Built-in mixer taps RAPID-BOX (2 way)
 Concealed body with buffers. ABS embedding box. Anti-moisture seal.

Monocomando incasso RAPID-BOX (2 vie)
 Corpo a incasso con smorzatori. Scatola da incasso in ABS. Guarnizione antiumidità.

Vestavěná jednopáková baterie RAPID-BOX (dvoucestná)
Podomítkové těleso s tlumiči. Krabice ABS k zabudování do zdi.
Těsnění proti vlhkosti.



20528001

128,00



Built-in mixer taps (1 way)
Built-in body included
Monocomando incasso (1 via)
 corpo incassato incluso

Vestavěná jednopáková baterie (jednocestná)
včetně podomítkového tělesa



20517701

72,55



Built-in mixer taps (2 way)
Built-in body included
Monocomando incasso (2 vie)
 corpo incassato incluso

Vestavěná jednopáková baterie (dvoucestná)
včetně podomítkového tělesa



20518001

122,00

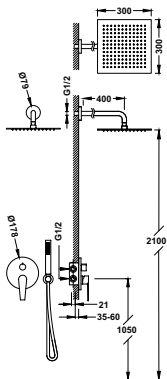

Concealed shower set RAPID-BOX

with water shut off and flow control.

- Built-in body included
- Stainless steel fixed shower head 300x300 mm. With ball joint.
- Elbow wall.
- Anti-limescale hand shower.
- Shower hose SATIN.

Kit doccia ad incasso RAPID-BOX

Con chiusura e regolazione di portata.

- Corpo incassato incluso
- Doccia fissa acciaio inossidabile 300x300 mm. con snodo.
- Supporto per doccia.
- Doccetta anticalcare.
- Flessibile satin.

Podomítkový jednopákový sprchový set RAPID-BOX

s uzávěrem a regulací průtoku.

- Včetně podomítkového tělesa
- Pevná sprcha 300x300 mm. s kloubem. Materiál nerez. oceli.
- Držák s nástěnným přívodem vody
- Ruční sprcha, proti usaz. vod. kamene.
- Flexi hadice SATIN.



20528004

356,00

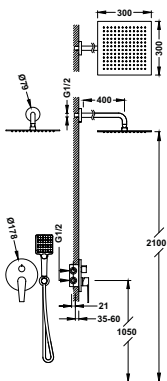

Concealed shower set RAPID-BOX

with water shut off and flow control.

- Built-in body included
- Stainless steel fixed shower head 300x300 mm. With ball joint.
- Elbow wall.
- Anti-limescale hand shower 96x110 mm. (3 jet types).
- Shower hose SATIN.

Kit doccia ad incasso RAPID-BOX

Con chiusura e regolazione di portata.

- Corpo incassato incluso
- Doccia fissa acciaio inossidabile 300x300 mm. con snodo.
- Supporto per doccia.
- Doccetta anticalcare 96x110 mm. (3 tipi di getto).
- Flessibile satin.

Podomítkový jednopákový sprchový set RAPID-BOX

s uzávěrem a regulací průtoku.

- Včetně podomítkového tělesa
- Pevná sprcha 300x300 mm. s kloubem. Materiál nerez. oceli.
- Držák s nástěnným přívodem vody
- Ruční sprcha, proti usaz. vod. kamene 96x110 mm. (3 typů proudění vody).
- Flexi hadice SATIN.



20528040

356,00

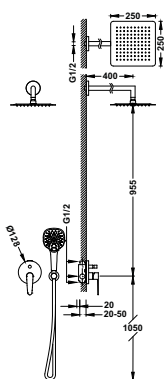

Concealed shower set

with water shut off and flow control.

- Built-in body included
- Fixed shower head 250x250 mm. with ball joint. Stainless material.
- Elbow wall.
- Anti-limescale hand shower (3 fonctions)
- Satin hose.

Kit doccia ad incasso

Con chiusura e regolazione di portata.

- Corpo incassato incluso
- Doccia fissa 250x250 mm. con snodo. Materiale acciaio inossidabile.
- Supporto per doccia.
- Doccetta anticalcare (3 funzioni).
- Flessibile satin.

Podomítkový jednopákový sprchový set

s uzávěrem a regulací průtoku.

- Včetně podomítkového tělesa
- Pevná sprcha 250x250 mm. s kloubem. Materiál nerezová ocel.
- Držák s nástěnným přívodem vody
- Ruční sprcha (3 funkce) proti usaz. vod. Kamene
- Flexi hadice SATIN.



20518006

356,00

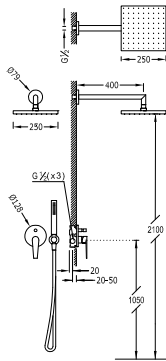

- Concealed shower set**
with water shut off and flow control.
- Built-in body included
 - Fixed shower head 250x250 mm. with ball joint.
 - Elbow wall.
 - Anti-limescale hand shower.
 - Satin hose.

- Kit doccia ad incasso**
Con chiusura e regolazione di portata.
- Corpo incassato incluso
 - Doccia fissa 250x250 mm. con snodo.
 - Supporto per doccia.
 - Doccetta anticalcare.
 - Flessibile satin.

- Podomítkový jednopákový sprchový set**
s uzávěrem a regulací průtoku.
- Včetně podomítkového tělesa
 - Pevná sprcha 250x250 mm. s kloubem.
 - Držák s nástěnným přívodem vody.
 - Ruční sprcha, proti usaz. vod. kamene.
 - Flexi hadice SATIN.



20518002

356,00

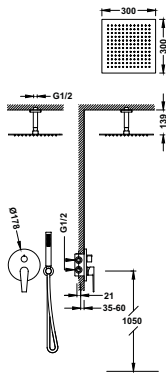

- Concealed shower set RAPID-BOX**
with water shut off and flow control.
- Built-in body included
 - Fixed shower head 300x300 mm. with ball joint. Stainless material.
 - Elbow wall.
 - Anti-limescale hand shower (3 functions)
 - Satin hose.

- Kit doccia ad incasso RAPID-BOX**
Con chiusura e regolazione di portata.
- Corpo incassato incluso
 - Doccia fissa 300x300 mm. con snodo. Materiale acciaio inossidabile.
 - Supporto per doccia.
 - Doccetta anticalcare (3 funzioni).
 - Flessibile satin.

- Podomítkový jednopákový sprchový set RAPID-BOX**
s uzávěrem a regulací průtoku.
- Včetně podomítkového tělesa
 - Pevná sprcha 300x300 mm. s kloubem. Materiál nerezová ocel.
 - Držák s nástěnným přívodem vody.
 - Ruční sprcha (3 funkce) proti usaz. vod. kamene
 - Flexi hadice SATIN.



20528003

337,00

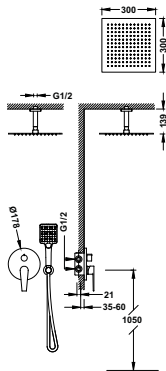

- Concealed shower set RAPID-BOX**
with water shut off and flow control.
- Built-in body included
 - Stainless steel fixed shower head 300x300 mm. with ball joint.
 - Elbow wall.
 - Anti-limescale hand shower 96x110 mm. (3 jet types).
 - Shower hose SATIN.

- Kit doccia ad incasso RAPID-BOX**
Con chiusura e regolazione di portata.
- Corpo incassato incluso
 - Doccia fissa acciaio inossidabile 300x300 mm. con snodo.
 - Supporto per doccia.
 - Doccetta anticalcare 96x110 mm. (3 tipi di getto).
 - Flessibile satin.

- Podomítkový jednopákový sprchový set RAPID-BOX**
s uzávěrem a regulací průtoku.
- Včetně podomítkového tělesa
 - Pevná sprcha 300x300 mm. s kloubem. Materiál nerez. oceli.
 - Držák s nástěnným přívodem vody.
 - Ruční sprcha, proti usaz. vod. kamene 96x110 mm. (3 typů proudění vody).
 - Flexi hadice SATIN.



20528030

337,00

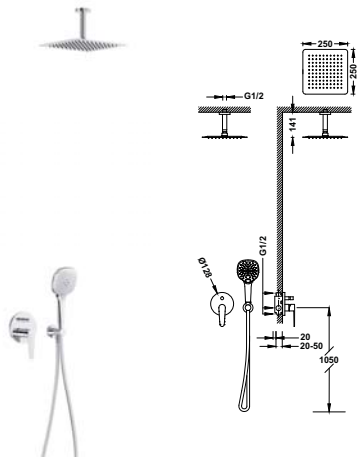

- Concealed shower set**
with water shut off and flow control.
- Built-in body included
 - Fixed shower head 250x250 mm. with ball joint. Stainless material.
 - Elbow wall.
 - Anti-limescale hand shower (3 fonctions)
 - Satin hose.

Kit doccia ad incasso

Con chiusura e regolazione di portata.

- Corpo incassato incluso
- Doccia fissa 250x250 mm. con snodo. Materiale acciaio inossidabile.
- Supporto per doccia.
- Doccetta anticalcare (3 funzioni).
- Flessibile satin.

Podomítkový jednopákový sprchový set

s uzávěrem a regulací průtoku.

- Včetně podomítkového tělesa
- Pevná sprcha 250x250 mm. s kloubem. Materiál nerezová ocel.
- Držák s nástěnným přívodem vody.
- Ruční sprcha (3 funkce) proti usaz. vod. Kamene
- Flexi hadice SATIN.



20518007

337,00

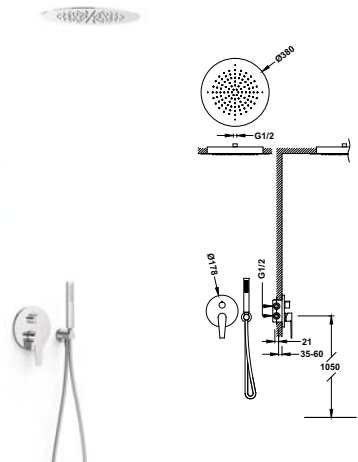

Concealed shower set RAPID-BOX

with water shut off and flow control.

- Built-in body included
- Steel shower head \varnothing 380 mm.
- Elbow wall.
- Anti-limescale hand shower.
- Shower hose SATIN.

Kit doccia ad incasso RAPID-BOX

Con chiusura e regolazione di portata.

- Corpo incassato incluso
- Soffione doccia acciaio inossidabile \varnothing 380 mm.
- Supporto per doccia.
- Doccetta anticalcare.
- Flessibile satin.

Podomítkový jednopákový sprchový set RAPID-BOX

s uzávěrem a regulací průtoku.

- Včetně podomítkového tělesa
- Sprchové křepátko z nerez. oceli \varnothing 380 mm.
- Držák s nástěnným přívodem vody.
- Ruční sprcha, proti usaz. vod. kamene.
- Flexi hadice SATIN.



20528005

782,00

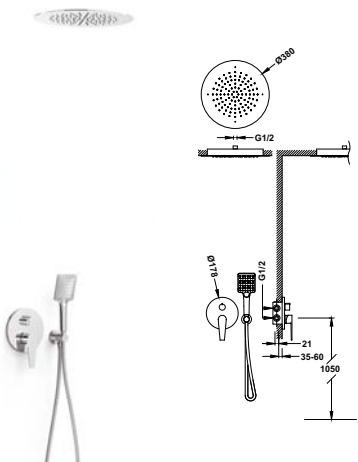

Concealed shower set RAPID-BOX

with water shut off and flow control.

- Built-in body included
- Steel shower head \varnothing 380 mm.
- Elbow wall.
- Anti-limescale hand shower \varnothing 110 mm. (3 jet types).
- Shower hose SATIN.

Kit doccia ad incasso RAPID-BOX

Con chiusura e regolazione di portata.

- Corpo incassato incluso
- Soffione doccia acciaio inossidabile \varnothing 380 mm.
- Supporto per doccia.
- Doccetta anticalcare \varnothing 110 mm. (3 tipi di getto).
- Flessibile satin.

Podomítkový jednopákový sprchový set RAPID-BOX

s uzávěrem a regulací průtoku.

- Včetně podomítkového tělesa
- Sprchové křepátko z nerez. oceli \varnothing 380 mm.
- Držák s nástěnným přívodem vody.
- Ruční sprcha, proti usaz. vod. Kamene \varnothing 110 mm. (3 typů proudění vody).
- Flexi hadice SATIN.



20528050

782,00

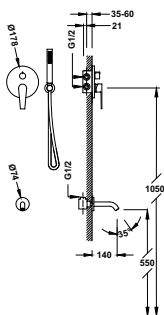

Concealed shower set RAPID-BOX

with water shut off and flow control.

- Built-in body included.
- Bath spout.
- Elbow wall.
- Anti-limescale hand shower.
- Shower hose SATIN.

Kit doccia ad incasso RAPID-BOX

Con chiusura e regolazione di portata.

- Corpo incassato incluso.
- Canna per vasca da bagno.
- Supporto per doccia.
- Doccia anticalcare.
- Flessibile satin.

Podomítkový jednopákový sprchový set RAPID-BOX

s uzávěrem a regulací průtoku.

- Včetně podomítkového tělesa.
- Kohoutek pro vanu.
- Držák s nástěnným přívodem vody.
- Ruční sprcha, proti usaz. vod. kamene.
- Flexi hadice SATIN.



20528006

283,00

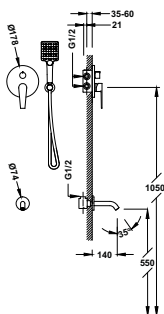

Concealed shower set RAPID-BOX

with water shut off and flow control.

- Built-in body included.
- Bath spout.
- Elbow wall.
- Anti-limescale hand shower Ø 110 mm. (3 jet types).
- Shower hose SATIN.

Kit doccia ad incasso RAPID-BOX

Con chiusura e regolazione di portata.

- Corpo incassato incluso.
- Canna per vasca da bagno.
- Supporto per doccia.
- Doccetta anticalcare Ø 110 mm. (3 tipi di getto).
- Flessibile satin.

Podomítkový jednopákový sprchový set RAPID-BOX

s uzávěrem a regulací průtoku.

- Včetně podomítkového tělesa.
- Kohoutek pro vanu.
- Držák s nástěnným přívodem vody.
- Ruční sprcha, proti usaz. vod. Kamene Ø 110 mm. (3 typů proudění vody).
- Flexi hadice SATIN.



20528060

283,00



Wall thermostatic shower mixer

Doccia termostatica
Termostatická sprchová baterie

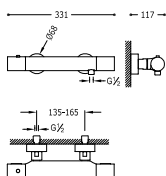

06116201

219,00



Wall thermostatic shower mixer

(Anti-limescale hand shower with directable support. Shower hose satin).

Doccia termostatica
(Doccetta anticalcare con supporto orientabile. Flessibile satin).

Termostatická sprchová baterie
(Ruční sprcha s nastavitelným držákem, proti usaz. vod. kamene a flexi hadice SATIN).

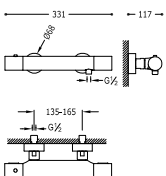

205164019

249,00



Wall thermostatic shower mixer

with cascade. Diverter integrated in the flow control.

Vasca-Doccia termostatica
con cascata. Invertitore integrato nel regolatore di portata.

Termostatická baterie pro vanu-sprchu
s kaskádou. Přepínač zabudovaný v regulaci průtoku.

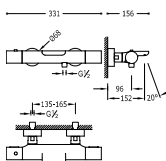

06117201

280,00



Wall thermostatic bath and shower mixer

with cascade (Anti-limescale hand shower with directable support. Shower hose satin). Diverter integrated in the flow control.

Vasca-Doccia termostatica
Con bocca a cascata (Doccetta anticalcare con supporto orientabile. Flessibile satin). Invertitore integrato nel regolatore di portata.

Termostatická baterie pro vanu-sprchu
s kaskádou (Ruční sprcha s nastavitelným držákem, proti usaz. vod. kamene a flexi hadice SATIN). Přepínač zabudovaný v regulaci průtoku.

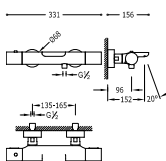

205174019

308,00



490 / Basin mixer taps | Lavabi | Koupelňová baterie



492 / Bidets | Bidet | Bidety



494 / Bathtub mixer taps | Monocomando esterno | Jednoplákový mechanismus vany

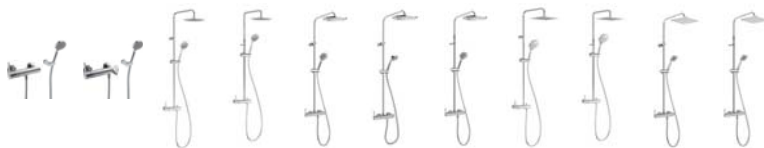

498 / Built-in sets | Monocomando ad incasso | Vestavěné soupravy



499 / Deck-mounted bathtubs | Bordovasca | Vany s prodlouženým pultem



500 / Thermostatically-controlled | Termostatica | Termostatické

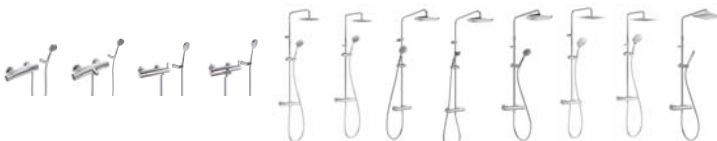

505 / Thermostatically-controlled (COMPACT) | Termostatiche / Termostatické (COMPACT)



505 / Shutoff valves | Rubinetti di arresto | Průchozí ventily



TRÉS

LEX-TRES



www.qtrr.es/lex-tres



Chrome
Cromato
Chrom

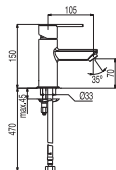

Single lever washbasin mixer
Easy-to-clean aerator.

Monocomando lavabo
Aeratore facile da pulire.

Jednopáková umyvadlová baterie
Perlátor se snadnou údržbou.



9134592 IIB

181103 92,50

186103 108,00

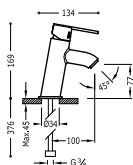

Single lever washbasin mixer
Easy-to-clean aerator.

Monocomando lavabo
Aeratore facile da pulire.

Jednopáková umyvadlová baterie
Perlátor se snadnou údržbou.



9134592

181903 98,50

186903 112,00

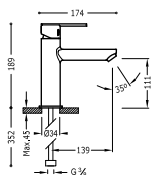

Single lever washbasin mixer
Easy-to-clean aerator.

Monocomando lavabo
Aeratore facile da pulire.

Jednopáková umyvadlová baterie
Perlátor se snadnou údržbou.



9134592

181203 120,00

186203 136,00

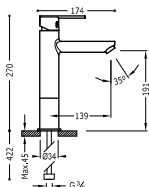

Single lever washbasin mixer
with base extension. Easy-to-clean aerator.

Monocomando lavabo
con prolunga inferiore. Aeratore facile da pulire.

Jednopáková umyvadlová baterie
s nástavcem. Perlátor se snadnou údržbou.



9134592

181217 194,00

186217 210,00

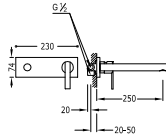

Single lever wall washbasin mixer
Built-in body is included and indivisible. Spout 250 mm.

Monomando a muro
Corpo incassato incluso e indivisibile. Canna 250 mm.

Jednopáková nástěnná baterie
Včetně nerozdělitelného zabudovaného tělesa. Ramínko 250 mm.



181200

246,00

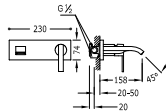

Single lever wall washbasin mixer
with cascade cast spout. Built-in body is included and indivisible.

Monomando a muro
con bocca a cascata. Corpo incassato incluso e indivisibile.

Jednopáková nástěnná baterie
ramínko s vodopádem. Včetně nerozdělitelného zabudovaného tělesa.



08126010

279,00

BIDETS | BIDEI | BIDEY

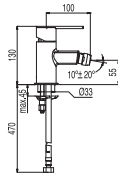

Single lever bidet mixer
Easy-to-clean aerator.

Monocomando bidet
Aeratore facile da pulire.

Jednopáková bidetová baterie
Perlátor se snadnou údržbou.



181120

96,85



186120

112,00

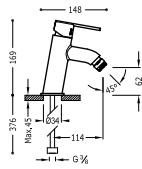

Single lever bidet mixer
Easy-to-clean aerator.

Monocomando bidet
Aeratore facile da pulire.

Jednopáková bidetová baterie
Perlátor se snadnou údržbou.



181920

103,00



186920

117,00

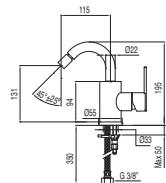

Single lever bidet mixer
Monocomando bidet

Jednopáková bidetová baterie



181224

163,00

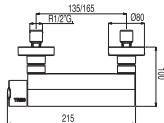
**Single lever shower mixer**

Massage hand shower \varnothing 100 mm. (5 fonctions) with directable support and satin hose.

Monocomando doccia

Doccetta massaggio \varnothing 100 mm. (5 funzioni) con supporto orientabile e flessibile satin.

Jednopáková sprchová baterie

Ruční masážní sprcha \varnothing 100 mm. (5 funkcí) s nastavitelným držákem. Flexi hadice SATIN.



9134592

IA

181468

145,00

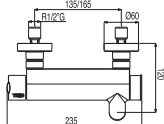
**Single lever bath and shower mixer**

Massage hand shower \varnothing 100 mm. (5 fonctions) with directable support and satin hose.

Monocomando vasca

Doccetta massaggio \varnothing 100 mm. (5 funzioni) con supporto orientabile e flessibile satin.

Jednopáková baterie pro vanu-sprchu

Ruční masážní sprcha \varnothing 100 mm. (5 funkcí) s nastavitelným držákem. Flexi hadice SATIN.



9134592

181474

158,00

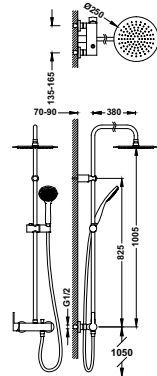
**Bar-shower set**

- Fixed shower head \varnothing 250 mm. with ball joint. Stainless material.
- Anti-limescale hand shower.
- Satin hose.

Set doccia

- Doccetta fissa \varnothing 250 mm. con snodo. Materiale acciaio inossidabile.
- Doccetta anticalcare.
- Flessibile satin.

Sprchová souprava, proti usaz. vod. kamene

- Pevná sprcha \varnothing 250 mm. s kloubem. Materiál nerezová ocel.
- Ruční sprcha, proti usaz. vod. Kamene.
- Flexi hadice SATIN.



9134592

18119102

396,00

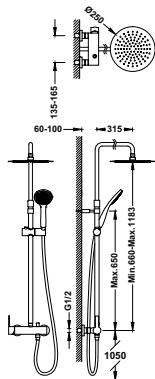

Bar-shower set

- Fixed shower head Ø 250 mm. with ball joint. Stainless material.
- Anti-limescale hand shower.
- Satin hose.
- Telescopic bar.

Set doccia

- Doccia fissa Ø 250 mm. con snodo. Materiale acciaio inossidabile.
- Doccetta anticalcare.
- Flessibile satin.
- Asta telescopica.

Sprchová souprava, proti usaz. vod. kamene

- Pevná sprcha Ø 250 mm. s kloubem. Materiál nerezová ocel.
- Ruční sprcha, proti usaz. vod. kamene.
- Flexi hadice SATIN.
- Teleshopická tyč.



08119703

435,00

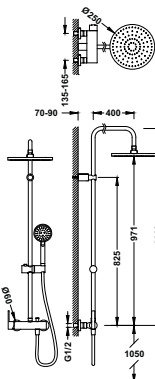

Bar-shower set

- Fixed shower head Ø 250 mm. with ball joint.
- Massage hand shower Ø 100 mm. (5 functions).
- Satin hose.

Set doccia

- Doccia fissa Ø 250 mm. con snodo.
- Doccetta Ø 100 mm. (5 funzioni).
- Flessibile satin.

Sprchová souprava, proti usaz. vod. kamene

- Pevná sprcha Ø 250 mm. s kloubem.
- Ruční masážní sprcha Ø 100 mm. (5 funkci).
- Flexi hadice SATIN.



181191

396,00

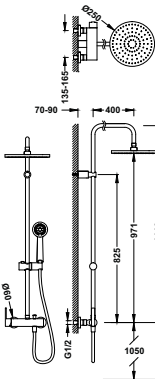

Bar-shower set

- Fixed shower head Ø 250 mm. with ball joint.
- Anti-limescale hand shower Ø 80 mm.
- Double interlocked shower hose.

Set doccia

- Doccia fissa Ø 250 mm. con snodo.
- Doccetta anticalcare Ø 80 mm.
- Flessibile doppia graffatura.

Sprchová souprava, proti usaz. vod. kamene

- Pevná sprcha Ø 250 mm. s kloubem.
- Ruční sprcha, proti usaz. vod. kamene Ø 80 mm.
- Flexi hadice s dvojitým zámkem.



081192

337,00

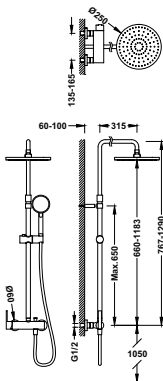
**Bar-shower set**

- Fixed shower head \varnothing 250 mm. with ball joint.
- Massage hand shower \varnothing 100 mm. (5 fonctions).
- Satin hose.
- Telescopic bar.

Set doccia

- Doccia fissa \varnothing 250 mm. con snodo.
- Doccetta \varnothing 100 mm. (5 funzioni).
- Flessibile satin.
- Asta telescopica.

Sprchová souprava, proti usaz. vod. kamene

- Pevná sprcha \varnothing 250 mm. s kloubem.
- Ruční masážní sprcha \varnothing 100 mm. (5 funkcí).
- Flexi hadice SATIN.
- Teleskopická tyč.



08119702

435,00

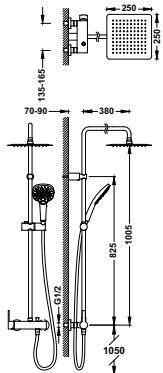
**Bar-shower set**

- Fixed shower head 250x250 mm. with ball joint. Stainless material.
- Anti-limescale hand shower (3 fonctions)
- Satin hose.

Set doccia

- Doccia fissa 250x250 mm. con snodo. Materiale acciaio inossidabile.
- Doccetta anticalcare (3 funzioni).
- Flessibile satin.

Sprchová souprava, proti usaz. vod. kamene

- Pevná sprcha 250x250 mm. s kloubem. Materiál nerezová ocel.
- Ruční sprcha (3 funkce) proti usaz. vod. Kamene
- Flexi hadice SATIN.



08119302

396,00

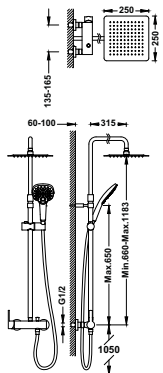
**Bar-shower set**

- Fixed shower head 250x250 mm. with ball joint. Stainless material.
- Anti-limescale hand shower (3 fonctions)
- Satin hose.
- Telescopic bar.

Set doccia

- Doccia fissa 250x250 mm. con snodo. Materiale acciaio inossidabile.
- Doccetta anticalcare (3 funzioni).
- Flessibile satin.
- Asta telescopica.

Sprchová souprava, proti usaz. vod. kamene

- Pevná sprcha 250x250 mm. s kloubem. Materiál nerezová ocel.
- Ruční sprcha (3 funkce) proti usaz. vod. Kamene
- Flexi hadice SATIN.
- Teleskopická tyč.



08119704

435,00

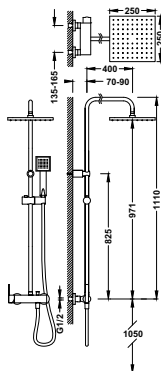

Bar-shower set

- Fixed shower head 250x250 mm. with ball joint.
- Anti-limescale hand shower.
- Satin hose.

Set doccia

- Doccia fissa 250x250 mm. con snodo.
- Doccetta anticalcare.
- Flessibile satin.

Sprchová souprava, proti usaz. vod. kamene

- Pevná sprcha 250x250 mm. s kloubem.
- Ruční sprcha, proti usaz. vod. kamene.
- Flexi hadice SATIN.



08119301

396,00

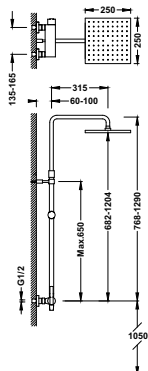

Bar-shower set

- Fixed shower head 250x250 mm. with ball joint.
- Anti-limescale hand shower.
- Satin hose.
- Telescopic bar.

Set doccia

- Doccia fissa 250x250 mm. con snodo.
- Doccetta anticalcare.
- Flessibile satin.
- Asta telescopica.

Sprchová souprava, proti usaz. vod. kamene

- Pevná sprcha 250x250 mm. s kloubem.
- Ruční sprcha, proti usaz. vod. kamene.
- Flexi hadice SATIN.
- Teleskopická tyč.



08119701

435,00

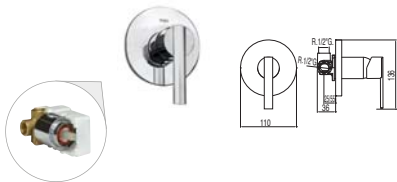
**Built-in mixer taps (1 way)****Built-in body included****Monocomando incasso (1 via)****corpo incassato incluso**

*Vestavěná jednopáková baterie (jednocestný)
včetně podomítkového tělesa*

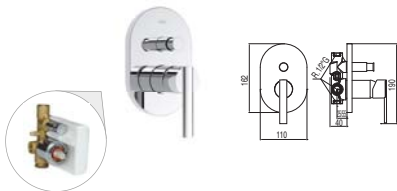

18117705

90,60**Built-in mixer taps (2 way)****Built-in body included****Monocomando incasso (2 vie)****corpo incassato incluso**

*Vestavěná jednopáková baterie (dvoucestný)
včetně podomítkového tělesa*

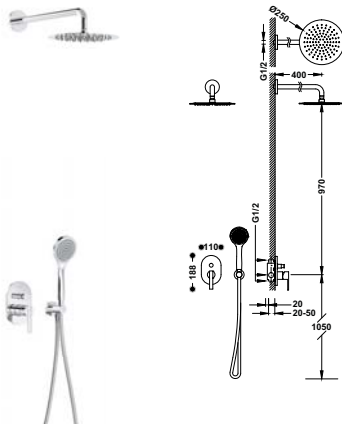

18118005

157,00**Concealed shower set****with water shut off and flow control.****Built-in body included**

- Fixed shower head Ø 250 mm. with ball joint. Stainless material.

- Elbow wall.

- Anti-limescale hand shower.

- Satin hose.

Kit doccia ad incasso

Con chiusura e regolazione di portata.

• Corpo incassato incluso

• Doccia fissa Ø 250 mm. con snodo. Materiale acciaio inossidabile.

• Supporto per doccia.

• Doccetta anticalcare.

• Flessibile satin.

*Podomítkový jednopákový sprchový set**s uzávěrem a regulací průtoku.*

• Včetně podomítkového tělesa

• Pevná sprcha Ø 250 mm. s kloubem. Materiál nerezová ocel.

• Držák s nástěnným přívodem vody.

• Ruční sprcha, proti usaz. vod. kamene.

• Flexi hadice SATIN.

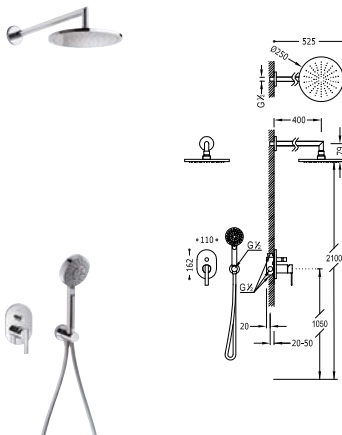

08118001

303,00**Concealed shower set****with water shut off and flow control.****Built-in body included****Fixed shower head Ø 250 mm. with ball joint.**

- Elbow wall.

- Massage hand shower Ø 100 mm. (5 fonctions).

- Satin hose.

Kit doccia ad incasso

Con chiusura e regolazione di portata.

• Corpo incassato incluso

• Doccia fissa Ø 250 mm. con snodo.

• Supporto per doccia.

• Doccetta Ø 100 mm. (5 funzioni).

• Flessibile satin.

*Podomítkový sprchový set baterie**s uzávěrem a regulací průtoku.*

• Včetně podomítkového tělesa

• Pevná sprcha Ø 250 mm. s kloubem.

• Držák s nástěnným přívodem vody.

• Ruční masážní sprcha Ø 100 mm (5 funkcí).

• Flexi hadice SATIN.



18118005

323,00

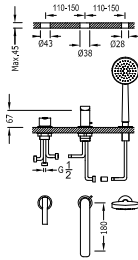

Bath-shower single lever tap for bracket shelf

- Massage hand shower Ø 100 mm. (5 fonctions).**
- Flowrate: 3 bar – 16 l/m.
 - Compatible with tank kit ref: 20324501.
 - Spout 180 mm.

Monocomando bordo vasca

- Doccetta massaggiø Ø 100 mm. (5 funzioni).**
- Portata: 3 bar – 16 l/m.
 - Compatibile con il kit serbatoio cod: 20324501.
 - Canna 180 mm.

Jednopáková vanová stojánková baterie

- Ruční masážní sprcha Ø 100 mm. (5 funkci).**
- Průtok: 3 bar – 16 l/m
 - Kompatibilní se sadou nádrže ref. č.: 20324501.
 - Rámčko 180 mm.



08116104

317,00

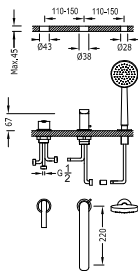

Bath-shower single lever tap for bracket shelf

- Massage hand shower Ø 100 mm. (5 fonctions).**
- Flowrate: 3 bar – 16 l/m.
 - Compatible with tank kit ref: 20324501.
 - Spout 220 mm.

Monocomando bordo vasca

- Doccetta massaggiø Ø 100 mm. (5 funzioni).**
- Portata: 3 bar – 16 l/m.
 - Compatibile con il kit serbatoio cod: 20324501.
 - Canna 220 mm.

Jednopáková vanová stojánková baterie

- Ruční masážní sprcha Ø 100 mm. (5 funkci).**
- Průtok: 3 bar – 16 l/m
 - Kompatibilní se sadou nádrže ref. č.: 20324501.
 - Rámčko 220 mm.



08116103

328,00



Bath-shower kit cistern

Kit bordo vasca

Set nádrže pro stojánkové vanové baterie

(per ref. / for Nr. / Kód: 06216103, 06216102, 20016203, 20016201, 08116104, 08116103, 20316102, 20316101).

20324501

381,00



Bath valve with drainage point

Valvola vasca con presa drenaggio

Vanový odpadový ventil

134445

86,00

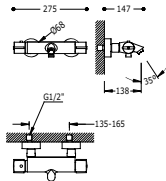

Badthermostaat

(Massage hand shower Ø 100 mm. (5 fonctions),with directable support. Shower hose satin). Diverter integrated in the flow control.

Vasca-Doccia termostatica (Doccetta Ø 100 mm. (5 funzioni),con supporto orientabile. Flessibile satin). Invertitore integrato nel regolatore di portata.

Termostatická baterie pro vanu-sprchu (Ruční masážní sprcha Ø 100 mm. (5 funkcí),s nastavitelným držákem, proti usaz. vod. kamene. Flexi hadice SATIN). Přepínač zabudovaný v regulaci průtoku.



918116110

1811749

276,00

Wall thermostatic shower mixer

Suitable for persons with physical disabilities.

Doccia termostatica

Indicato per persone con disabilità fisiche

Termostatická sprchová baterie

Určeno pro osoby s fyzickým handicapem

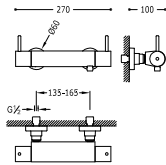

29919509

09026401

198,00

Wall thermostatic shower mixer

Anti-limescale hand shower with directable support. Shower hose satin. Suitable for persons with physical disabilities.

Doccia termostatica

Doccetta anticalcare con supporto orientabile. Flessibile satin. Indicato per persone con disabilità fisiche

Termostatická sprchová baterie

Ruční sprcha s nastavitelným držákem, proti usaz. vod. kamene a flexi hadice SATIN. Určeno pro osoby s fyzickým handicapem

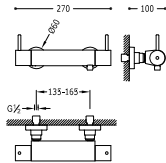

29919509

09096401

230,00

Wall thermostatic shower mixer

Suitable for persons with physical disabilities. Diverter integrated in the flow control.

Vasca-Doccia termostatica

Indicato per persone con disabilità fisiche. Invertitore integrato nel regolatore di portata.

Termostatická baterie pro vanu-sprchu

Určeno pro osoby s fyzickým handicapem. Přepínač zabudovaný v regulaci průtoku.

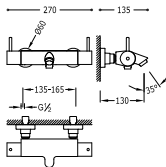

29919509

09027401

250,00

Wall thermostatic shower mixer

Anti-limescale hand shower with directable support. Shower hose satin. Suitable for persons with physical disabilities. Diverter integrated in the flow control.

Vasca-Doccia termostatica

Doccetta anticalcare con supporto orientabile. Flessibile satin. Indicato per persone con disabilità fisiche. Invertitore integrato nel regolatore di portata.

Termostatická baterie pro vanu-sprchu

Ruční sprcha s nastavitelným držákem, proti usaz. vod. kamene a flexi hadice SATIN.). Určeno pro osoby s fyzickým handicapem. Přepínač zabudovaný v regulaci průtoku.

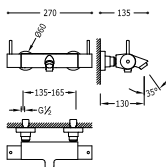

29919509

09097401

284,00

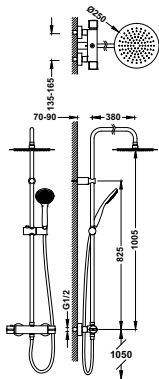
**Wall thermostatic shower mixer**

- Fixed shower head \varnothing 250 mm. with ball joint. Stainless material.
- Anti-limescale hand shower.
- Satin hose.
- Diverter integrated in the flow control.

Set doccia termostatica

- Doccia fissa \varnothing 250 mm. con snodo. Materiale acciaio inossidabile.
- Doccetta anticalcare.
- Tubo flessibile satin.
- Invertitore integrato nel regolatore di portata.

Souprava termostatické sprchové baterie

- Pevná sprcha \varnothing 250 mm. s kloboum. Materiál nerezová ocel.
- Ruční sprcha, proti usaz. vod. Kamene.
- Flexí hadice SATIN.
- Přepínač zabudovaný v regulaci průtoku.



18138502

422,00

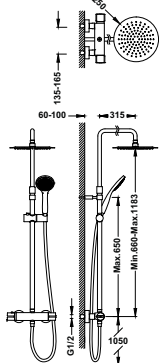
**Wall thermostatic shower mixer**

- Fixed shower head \varnothing 250 mm. with ball joint. Stainless material.
- Anti-limescale hand shower.
- Satin hose.
- Telescopic bar.
- Diverter integrated in the flow control.

Set doccia termostatica

- Doccia fissa \varnothing 250 mm. con snodo. Materiale acciaio inossidabile.
- Doccetta anticalcare.
- Flessibile satin.
- Asta telescopica.
- Invertitore integrato nel regolatore di portata.

Souprava termostatické sprchové baterie

- Pevná sprcha \varnothing 250 mm. s kloboum. Materiál nerezová ocel.
- Ruční sprcha, proti usaz. vod. Kamene.
- Flexí hadice SATIN.
- Teleskopická tyč.
- Přepínač zabudovaný v regulaci průtoku.



19021402

481,00

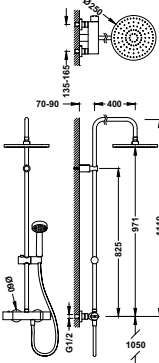
**Wall thermostatic shower mixer**

- Fixed shower head \varnothing 250 mm. with ball joint.
- Massage hand shower \varnothing 100 mm. (5 fonctions).
- Satin hose.
- Diverter integrated in the flow control.

Set doccia termostatica

- Doccia fissa \varnothing 250 mm. con snodo.
- Doccetta massaggi \varnothing 100 mm. (5 funzioni).
- Tubo flessibile satin.
- Invertitore integrato nel regolatore di portata.

Souprava termostatické sprchové baterie

- Pevná sprcha \varnothing 250 mm. s kloboum.
- Ruční masážní sprcha \varnothing 100 mm. (5 funkcí).
- Flexí hadice SATIN.
- Přepínač zabudovaný v regulaci průtoku.



181385

436,00

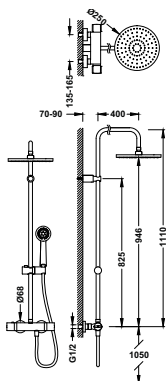

Set doccia termostatica

- Doccia fissa \varnothing 250 mm.
- Doccia mobile anticalcarea \varnothing 80 mm.
- Flessibile doppia graffatura.
- Invertitore integrato nel regolatore di portata.

Wall thermostatic shower mixer

- Fixed shower head \varnothing 250 mm.
- Anti-limescale hand shower \varnothing 80 mm.
- Double interlocked shower hose.
- Diverter integrated in the flow control.

Souprava termostatické sprchové baterie

- Pevná sprcha \varnothing 250 mm.
- Ruční sprcha proti usazování vod. kamene \varnothing 80 mm.
- Flexi hadice s dvojným zámekem.
- Přepínač zabudovaný v regulaci průtoku.



181386

415,00

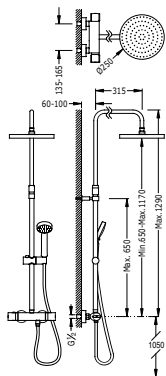

Wall thermostatic shower mixer

- Fixed shower head \varnothing 250 mm. with ball joint.
- Massage hand shower \varnothing 100 mm. (5 fonctions)
- Satin hose.
- Telescopic bar.
- Diverter integrated in the flow control.

Set doccia termostatica

- Doccia fissa \varnothing 250 mm. con snodo.
- Doccetta massaggio \varnothing 100 mm. (5 funzioni).
- Flessibile satin.
- Asta telescopica.
- Invertitore integrato nel regolatore di portata.

Souprava termostatické sprchové baterie

- Pevná sprcha \varnothing 250 mm. s kloubem.
- Ruční masážní sprcha \varnothing 100 mm. (5 funkcí).
- Flexi hadice SATIN.
- Teleskopická tyč.
- Přepínač zabudovaný v regulaci průtoku.



190214

481,00

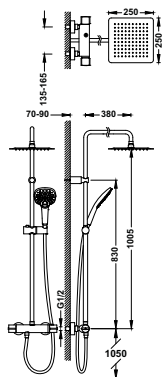

Wall thermostatic shower mixer

- Fixed shower head 250x250 mm. with ball joint. Stainless material.
- Anti-limescale hand shower (3 fonctions)
- Satin hose.
- Diverter integrated in the flow control.

Set doccia termostatica

- Doccia fissa 250x250 mm. con snodo. Materiale acciaio inossidabile.
- Doccetta anticalcare (3 funzioni).
- Tubo flessibile satin.
- Invertitore integrato nel regolatore di portata.

Souprava termostatické sprchové baterie

- Pevná sprcha 250x250 mm. s kloubem. Materiál nerezová ocel.
- Ruční sprcha (3 funkcí) proti usaz. vod. Kamene
- Flexi hadice SATIN.
- Přepínač zabudovaný v regulaci průtoku.



18138503

422,00

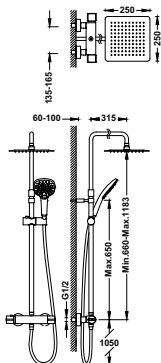
**Wall thermostatic shower mixer**

- Fixed shower head 250x250 mm. with ball joint. Stainless material.
- Anti-limescale hand shower (3 fonctions)
- Satin hose.
- Telescopic bar.
- Diverter integrated in the flow control.

Set doccia termostatica

- Doccia fissa 250x250 mm. con snodo. Materiale acciaio inossidabile.
- Doccetta anticalcare (3 funzioni).
- Flessibile satin.
- Asta telescopica.
- Invertitore integrato nel regolatore di portata.

Souprava termostatické sprchové baterie

- Pevná sprcha 250x250 mm. s kloubem. Materiál nerezová ocel.
- Ruční sprcha (3 funkce) proti usaz. vod. Kamene
- Flexi hadice SATIN.
- Teleskopická tyč.
- Přepínač zabudovaný v regulaci průtoku.



918116110

19021302

476,00

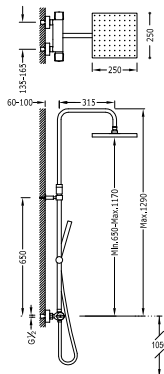
**Wall thermostatic shower mixer**

- Fixed shower head 250x250 mm. with ball joint.
- Anti-limescale hand shower.
- Satin hose.
- Telescopic bar.
- Diverter integrated in the flow control.

Set doccia termostatica

- Doccia fissa 250x250 mm. con snodo.
- Doccetta anticalcare.
- Flessibile satin.
- Asta telescopica.
- Invertitore integrato nel regolatore di portata.

Souprava termostatické sprchové baterie

- Pevná sprcha 250x250 mm. s kloubem.
- Ruční sprcha, proti usaz. vod. kamene.
- Flexi hadice SATIN.
- Teleskopická tyč.
- Přepínač zabudovaný v regulaci průtoku.



918116110

190213

476,00

THERMOSTATICALLY-CONTROLLED SETS | GRUPPI TERMOSTATICI | TERMOSTATICKÉ SOUPRAVY (COMPACT)

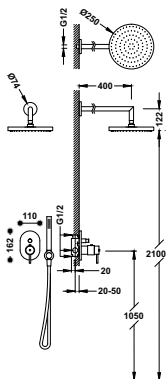

Concealed thermostatic shower kit with water shut off and flow control (2 ways).

- Built-in body included
- Fixed shower head Ø 250 mm. with ball joint.
- Elbow wall.
- Anti-limescale hand shower.
- Satin hose.

Kit termostatico doccia ad incasso con chiusura e regolazione di portata (2 vie).

- Corpo incassato incluso
- Doccia fissa Ø 250 mm. con snodo.
- Supporto per doccia.
- Doccetta anticalcare.
- Flessibile satin.

Podomítkový sprchový set termostatické bateri s uzávěrem a regulací průtoku (2-cestná).

- Včetně podomítkového tělesa
- Pevná sprcha Ø 250 mm. s kloubem.
- Držák s nástěnným přívodem vody.
- Ruční sprcha, proti usaz. vod. kamene.
- Flexi hadice SATIN.



09096022

549,00



SHUTOFF VALVES | RUBINETTI DI ARRESTO | PRŮCHOZÍ VENTILY

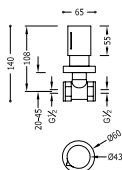

1/2" threaded-ends gate-valve

Rubinetto di arresto filettato 1/2"

Uzavírací ventil 1/2"

06115501

74,70

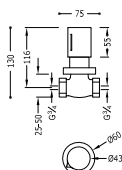

3/4" threaded-ends gate-valve

Rubinetto di arresto filettato 3/4"

Uzavírací ventil 3/4"

06151101

82,90

508 / **Basin mixer taps** | Lavabi | Koupelnová baterie511 / **Bidets** | Bidet | Bidety512 / **Bathtub mixer taps** | Monocomando esterno | Jednopákový mechanismus vany513 / **Built-in sets** | Monocomando ad incasso | Vestavěné soupravy514 / **Deck-mounted bathtubs** | Bordovasca | Vany s prodlouženým pultem515 / **Thermostatically-controlled** | Termostatica | Termostatické517 / **Thermostatically-controlled** | Termostatiche | Termostatické (COMPACT)

TRÉS

ALPLUS



www.qtr.es/alplus

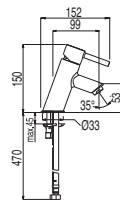

Chrome
Cromato
Chrom

**Single lever washbasin mixer**

Monocomando lavabo

Jednopáková umyvadlová baterie



9134592 IIB

■ 20310301

76,20

■ 20310301D

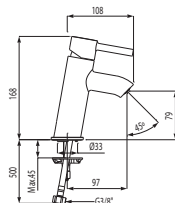
91,50**Single lever washbasin mixer**

Monocomando lavabo

Jednopáková umyvadlová baterie



9134592

■ 20390301

98,50

■ 20390301D

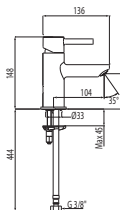
113,00**Single lever washbasin mixer**

Monocomando lavabo

Jednopáková umyvadlová baterie



9134592 IIB

■ 20310303

92,50

■ 20310303D

108,00

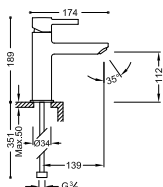

Single lever washbasin mixer
Monocomando lavabo
Jednápáková umyvadlová baterie



9134592

■ 20320301 **120,00**

■ 20320301D **136,00**

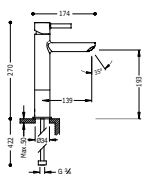

Single lever washbasin mixer with base extension
Monocomando lavabo con prolunga inferiore
Jednápáková umyvadlová baterie s nástavcem



9134592

■ 20321701 **194,00**

■ 20321701D **210,00**

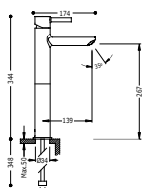

Single lever washbasin mixer with base extension
Monocomando lavabo con prolunga inferiore
Jednápáková umyvadlová baterie s nástavcem



9134592

■ 20320701 **225,00**

■ 20320701D **240,00**

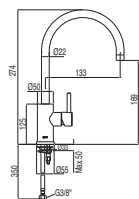

Single lever washbasin mixer
Monocomando lavabo
Jednápáková umyvadlová baterie



9134592

■ 20370301 **165,00**

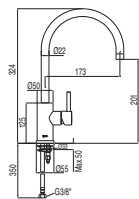

Single lever washbasin mixer
Monocomando lavabo
Jednápáková umyvadlová baterie



9134592

■ 20340301 **177,00**

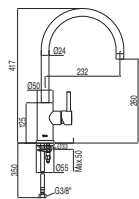

Single lever washbasin mixer
Monocomando lavabo
Jednápáková umyvadlová baterie



9134592

■ 20330301 **190,00**

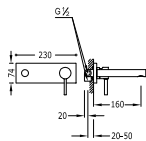
**Single lever wall washbasin mixer****Built-in body is included and indivisible. Spout 160 mm.****Monomando a muro****Corpo incassato incluso e indivisibile. Canna 160 mm.***Jednopáková nástěnná baterie**Včetně nerozdělitelného zabudovaného tělesa. Ramínko 160 mm.*

9134592

20321001

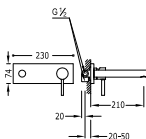
228,00**Single lever wall washbasin mixer****Built-in body is included and indivisible. Spout 210 mm.****Monomando a muro****Corpo incassato incluso e indivisibile. Canna 210 mm.***Jednopáková nástěnná baterie**Včetně nerozdělitelného zabudovaného tělesa. Ramínko 210 mm.*

9134592

20320002

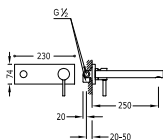
240,00**Single lever wall washbasin mixer****Built-in body is included and indivisible. Spout 250 mm.****Monomando a muro****Corpo incassato incluso e indivisibile. Canna 250 mm.***Jednopáková nástěnná baterie**Včetně nerozdělitelného zabudovaného tělesa. Ramínko 250 mm.*

9134592

20320001

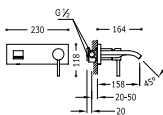
246,00**Single lever wall washbasin mixer****with cascade cast spout. Built-in body is included and indivisible.****Monomando a muro****con bocca a cascata. Corpo incassato incluso e indivisibile.***Jednopáková nástěnná baterie**ramínko s vodopádem. Včetně nerozdělitelného zabudovaného tělesa.*

913459210

20326010

279,00

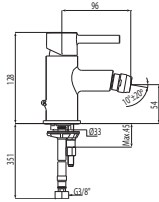

Single lever bidet mixer
Monocomando bidet
Jednápáková bidetová baterie



- 20312003 **96,85**
- 20312003D **113,00**

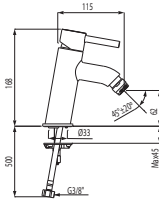

Single lever bidet mixer
Monocomando bidet
Jednápáková bidetová baterie



- 20392001 **103,00**
- 20392001D **117,00**

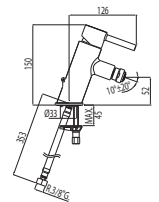

Single lever bidet mixer
Monocomando bidet
Jednápáková bidetová baterie



- 20312001 **76,20**
- 20312001D **91,50**

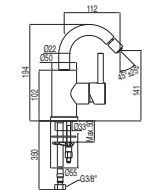

Single lever bidet mixer
Monocomando bidet
Jednápáková bidetová baterie

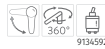

- 20322401 **163,00**

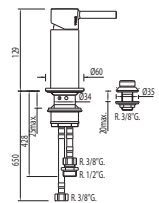

Bidet mixer tap with small shower
Monocomando bidet con doccetta
Jednápáková bidetová baterie se sprškou



- 20313001 **120,00**

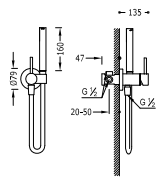

Concealed single lever bidet/toilets
Left or right support, interchangeable. Sateen hose.
Monocomando ad incasso per bidé WC
Supporto a destra o a sinistra, intercambiabile. Flesso satinato.
Jednápáková podomítková baterie pro bidet WC
Výměnitelný držák zprava či zleva. Sprchová mosazná baterie s omešovacím hrdlem 5 l/m. Systém proti kapání a flexi hadice SATIN



- 134123 **159,00**

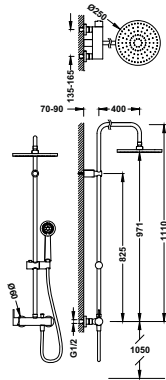

Bar-shower set

- Fixed shower head Ø 250 mm. with ball joint.
- Anti-limescale hand shower.
- Satin hose.

Set doccia

- Doccia fissa Ø 250 mm. con snodo.
- Doccetta anticalcare.
- Flessibile satin.

Sprchová souprava, proti usaz. vod. kamene

- Pevná sprcha Ø 250 mm. s kloubem.
- Ruční sprcha, proti usaz. vod. kamene.
- Flexi hadice SATIN.



20319101

383,00

BUILT-IN SETS | GRUPPI AD INCASSO | VESTAVĚNÉ SOUPRAVY

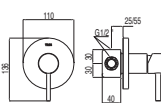

Built-in mixer taps (1 way)

Built-in body included

Monocomando incasso (1 via)
corpo incassato incluso

Vestavěná jednopáková baterie (jednocestná)
včetně podomítkového tělesa



20317701

75,10

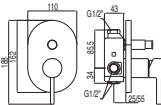

Built-in mixer taps (2 way)

Built-in body included

Monocomando incasso (2 vie)
corpo incassato incluso

Vestavěná jednopáková baterie (dvoucestná)
včetně podomítkového tělesa



20318001

142,00

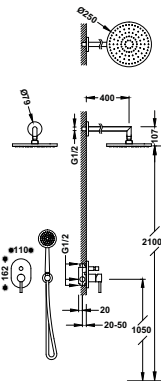

Concealed shower set

with water shut off and flow control.

- Built-in body included
- Fixed shower head Ø 250 mm. with ball joint.
- Elbow wall.
- Anti-limescale hand shower.
- Satin hose.

Kit doccia ad incasso

con chiusura e regolazione di portata.

- Corpo incassato incluso
- Doccia fissa Ø 250 mm. con snodo.
- Supporto per doccia.
- Doccetta anticalcare.
- Flessibile satin.

Sprchový podomítkový set

- s uzávěrem a regulací průtoku.
- Včetně podomítkového tělesa
- Pevná sprcha Ø 250 mm. s kloubem.
- Držák s nástěnným přívodem vody.
- Ruční sprcha, proti usaz. vod. kamene.
- Flexi hadice SATIN.



20318002

303,00

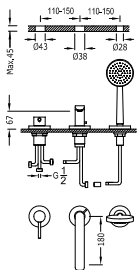
**Bath-shower single lever tap for bracket shelf****Anti-limescale hand shower.**

- Flowrate: 3 bar – 16 l/m.
- Compatible with tank kit ref: 20324501.
- Spout 180 mm.

Monocomando bordo vasca**Doccetta anticalcare.**

- Portata: 3 bar – 16 l/m.
- Compatibile con il kit serbatoio cod: 20324501.
- Canna 180 mm.

Jednopávková stojánková vanová baterie**Sprcha, proti usaz. vod. kamene.**

- Průtok: 3 bar – 16 l/m
- Kompatibilní se sadou nádrže ref. č.: 20324501.
- Ramínko 180 mm.



20316102

304,00

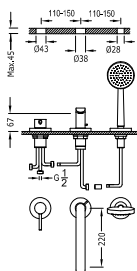
**Bath-shower single lever tap for bracket shelf****Anti-limescale hand shower.**

- Flowrate: 3 bar – 16 l/m.
- Compatible with tank kit ref: 20324501.
- Spout 220 mm.

Monocomando bordo vasca**Doccetta anticalcare.**

- Portata: 3 bar – 16 l/m.
- Compatibile con il kit serbatoio cod: 20324501.
- Canna 220 mm.

Jednopávková stojánková vanová baterie**Sprcha, proti usaz. vod. kamene.**

- Průtok: 3 bar – 16 l/m
- Kompatibilní se sadou nádrže ref. č.: 20324501.
- Ramínko 220 mm.



20316101

317,00

**Bath-shower kit cistern****Kit bordo vasca****Set nádrže pro stojánkové vanové baterie**

(per ref. / for Nr. / Kód: 06216103, 06216102, 20016203, 20016201, 08116104, 08116103, 20316102, 20316101).

20324501

381,00

**Bath valve with drainage point****Valvola vasca con presa drenaggio****Vanový odpadový ventil**

134445

86,00

Wall thermostatic shower mixer

Doccia termostatica

Termostatická sprchová baterie

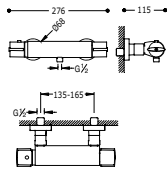

181164

174,00

Wall thermostatic shower mixer

(Massage hand shower Ø 100 mm. (5 fonctions) with directable support and satin hose).

Doccia termostatica

(Doccetta Ø 100 mm. (5 funzioni) con supporto orientabile e flessibile satin).

Termostatická sprchová baterie

(Ruční masážní sprcha Ø 100 mm. (5 funkcí) s nastavitelným držákem. Flexi hadice SATIN).

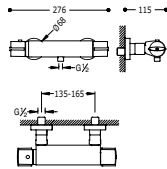

1811649

223,00

Badthermostaat

Diverter integrated in the flow control.

Vasca-Doccia termostatica

Invertitore integrato nel regolatore di portata.

Termostatická baterie pro vanu-sprchu

Přepínač zabudovaný v regulaci průtoku.

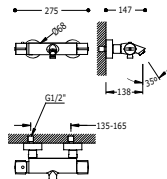

181174

231,00

Badthermostaat

(Massage hand shower Ø 100 mm. (5 fonctions).with directable support. Shower hose satin). Diverter integrated in the flow control.

Vasca-Doccia termostatica

(Doccetta Ø 100 mm. (5 funzioni).con supporto orientabile. Flessibile satin). Invertitore integrato nel regolatore di portata.

Termostatická baterie pro vanu-sprchu

(Ruční masážní sprcha Ø 100 mm. (5 funkcí) s nastavitelným držákem, proti usaz. vod. kamene. Flexi hadice SATIN). Přepínač zabudovaný v regulaci průtoku.

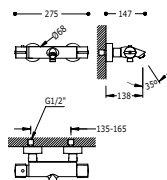

1811749

276,00

Wall thermostatic shower mixer

Suitable for persons with physical disabilities.

Doccia termostatica

Indicato per persone con disabilità fisiche

Termostatická sprchová baterie

Určeno pro osoby s fyzickým handicapem

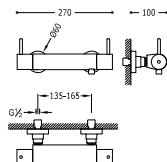

09026401

198,00

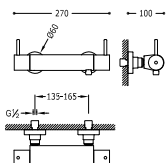
**Wall thermostatic shower mixer**

Anti-limescale hand shower with directable support. Shower hose satin. Suitable for persons with physical disabilities.

Doccia termostatica

Doccetta anticalcare con supporto orientabile. Flessibile satin. Indicato per persone con disabilità fisiche

Termostatická sprchová baterie

Ruční sprcha s nastavitelným držákem, proti usaz. vod. kamene a flexi hadice SATIN. Určeno pro osoby s fyzickým handicapem



29919509

09096401

230,00

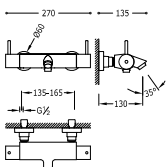
**Wall thermostatic shower mixer**

Suitable for persons with physical disabilities. Diverter integrated in the flow control.

Vasca-Doccia termostatica

Indicato per persone con disabilità fisiche. Invertitore integrato nel regolatore di portata.

Termostatická baterie pro vanu-sprchu

Určeno pro osoby s fyzickým handicapem. Přepínač zabudovaný v regulaci průtoku.



29919509

09027401

250,00

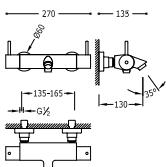
**Wall thermostatic shower mixer**

Anti-limescale hand shower with directable support. Shower hose satin. Suitable for persons with physical disabilities. Diverter integrated in the flow control.

Vasca-Doccia termostatica

Doccetta anticalcare con supporto orientabile. Flessibile satin. Indicato per persone con disabilità fisiche. Invertitore integrato nel regolatore di portata.

Termostatická baterie pro vanu-sprchu

Ruční sprcha s nastavitelným držákem, proti usaz. vod. kamene a flexi hadice SATIN. Určeno pro osoby s fyzickým handicapem. Přepínač zabudovaný v regulaci průtoku.



29919509

09097401

284,00

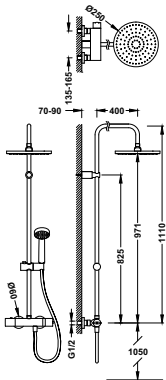
**Wall thermostatic shower mixer**

- Fixed shower head Ø 250 mm. with ball joint.
- Massage hand shower Ø 100 mm. (5 functions).
- Satin hose.
- Diverter integrated in the flow control.

Set doccia termostatica

- Doccetta fissa Ø 250 mm. con snodo.
- Doccetta massaggi Ø 100 mm. (5 funzioni).
- Tubo flessibile satin.
- Invertitore integrato nel regolatore di portata.

Souprava termostatické sprchové baterie

- Pevná sprcha Ø 250 mm. s kloubem.
- Ruční masážní sprcha Ø 100 mm. (5 funkcí).
- Flexi hadice SATIN.
- Přepínač zabudovaný v regulaci průtoku.



918116110

181385

436,00

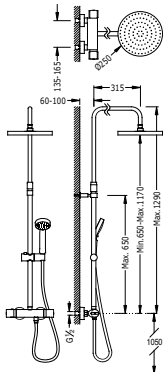

Wall thermostatic shower mixer

- Fixed shower head Ø 250 mm. with ball joint.
- Massage hand shower Ø 100 mm. (5 fonctions)
- Satin hose.
- Telescopic bar.
- Diverter integrated in the flow control.

Set doccia termostatica

- Doccia fissa Ø 250 mm. con snodo.
- Doccetta massaggio Ø 100 mm. (5 funzioni).
- Flessibile satin.
- Asta telescopica.
- Invertitore integrato nel regolatore di portata.

Souprava termostatické sprchové baterie

- Pevná sprcha Ø 250 mm. s kloubem.
- Ruční masážní sprcha Ø 100 mm. (5 funkcí).
- Flexi hadice SATIN.
- Teleshopická tyč.
- Přepínač zabudovaný v regulaci průtoku.



190214

481,00

THERMOSTATICALLY-CONTROLLED SETS | GRUPPI TERMOSTATICI | TERMOSTATICKÉ SOUPRAVY (COMPACT)

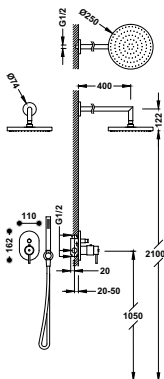

Concealed thermostatic shower kit

- with water shut off and flow control (2 ways).
- Built-in body included
- Fixed shower head Ø 250 mm. with ball joint.
- Elbow wall.
- Anti-limescale hand shower.
- Satin hose.

Kit termostatico doccia ad incasso
con chiusura e regolazione di portata (2 vie).

- Corpo incassato incluso
- Doccia fissa Ø 250 mm. con snodo.
- Supporto per doccia.
- Doccetta anticalcare.
- Flessibile satin.

Podomítkový sprchový set termostatické baterie

- s uzavěrem a regulací průtoku (2-cestná).
- Včetně podomítkového tělesa
- Pevná sprcha Ø 250 mm. s kloubem.
- Držák s nástěnným přívodem vody.
- Ruční sprcha, proti usaz. vod. kamene.
- Flexi hadice SATIN.



09096022

549,00

520 / **Basin mixer taps** | Lavabi | Koupelnová baterie521 / **Bidets** | Bidet | Bidety521 / **Bathtub mixer taps** | Monocomando esterno | Jednopákový mechanismus vany522 / **Built-in sets** | Monocomando ad incasso | Vestavěné soupravy**Thermostatically-controlled** | Termostatica /525 / **Termostatické**529 / **Shutoff valves** | Rubinetti di arresto | Průchozí ventily

TRES

FLAT-TRES



www.qtr.es/flat-tres

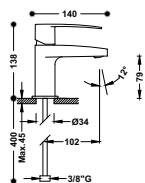

Chrome
Cromato
Chrom

**Single lever washbasin mixer**

Monocomando lavabo

Jednopáková umyvadlová baterie

9130190

20410301

60,15

20410301D

72,20

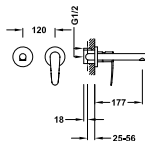
**Single lever wall washbasin mixer****Indivisible concealed body with buffers. Anti-moisture seal. Spout 177 mm.**

Monomando a muro

Corpo a incasso indivisibile con smorzatori. Guarnizione antiumidità. Canna 177 mm.

*Jednopáková nástěnná baterie**Podomítkové těleso v nedělitelném provedení s tlumiči. Těsnění proti vlhkosti. Ramínko 177 mm.*

29903507

20430001

158,00

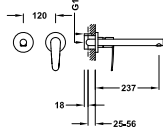
**Single lever wall washbasin mixer****Indivisible concealed body with buffers. Anti-moisture seal. Spout 237 mm.**

Monomando a muro

Corpo a incasso indivisibile con smorzatori. Guarnizione antiumidità. Canna 237 mm.

*Jednopáková nástěnná baterie**Podomítkové těleso v nedělitelném provedení s tlumiči. Těsnění proti vlhkosti. Ramínko 237 mm.*

29903507

20430002

168,00

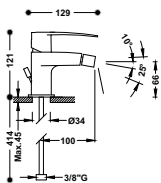

Single lever bidet mixer
Monocomando bidet
Jednopáková bidetová baterie



■ 20412001 61,25

■ 20412001D 73,30

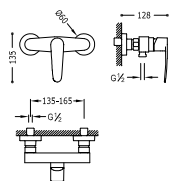

Single lever shower mixer
Anti-limescale hand shower with directable support. Shower hose satin.

Monocomando doccia
Doccetta anticalcare con supporto orientabile. Flessibile satin.

Jednopáková sprchová baterie
Ruční sprcha s nastavitelným držákem, proti usaz. vod. kamene a flexi hadice SATIN.



■ 20416701 97,35

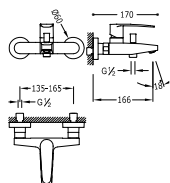

Single lever bath and shower mixer
Anti-limescale hand shower with directable support. Shower hose satin.

Monocomando vasca
Doccetta anticalcare con supporto orientabile. Flessibile satin.

Jednopáková baterie pro vanu-sprchu
Ruční sprcha, proti usaz. vod. kamene, proti usaz. vod. kamene a flexi hadice SATIN.

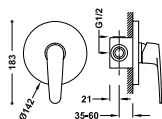

■ 20417001 108,00

**Built-in mixer taps RAPID-BOX (1 way)**

Concealed body with buffers. ABS embedding box. Anti-moisture seal.

Monocomando incasso RAPID-BOX (1 via)

Corpo a incasso con smorzatori. Scatola da incasso in ABS. Guarnizione antiumidità.

Vestavěná jednopávková baterie RAPID-BOX (jednocestný)
Podomítkové těleso s tlumiči. Krabice ABS k zabudování do zdi.
Těsnění proti vlhkosti.



29903507

20427701

67,80

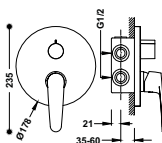
**Built-in mixer taps RAPID-BOX (2 way)**

Concealed body with buffers. ABS embedding box. Anti-moisture seal.

Monocomando incasso RAPID-BOX (2 vie)

Corpo a incasso con smorzatori. Scatola da incasso in ABS. Guarnizione antiumidità.

Vestavěná jednopávková baterie RAPID-BOX (dvoucestný)
Podomítkové těleso s tlumiči. Krabice ABS k zabudování do zdi.
Těsnění proti vlhkosti.



29903507

20428001

114,00

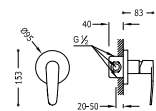
**Built-in mixer taps (1 way)**

Built-in body included

Monocomando incasso (1 via)

corpo incassato incluso

Vestavěná jednopávková baterie (jednocestný)
včetně podomítkového tělesa



9130190

20417701

64,55

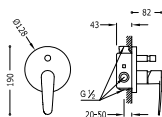
**Built-in mixer taps (2 way)**

Built-in body included

Monocomando incasso (2 vie)

corpo incassato incluso

Vestavěná jednopávková baterie (dvoucestný)
včetně podomítkového tělesa



9130190

20418001

108,00

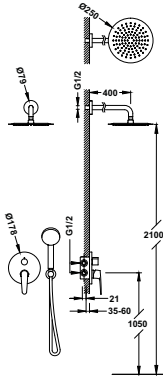

Concealed shower set RAPID-BOX

with water shut off and flow control.

- Built-in body included
- Stainless steel fixed shower head Ø 250 mm. With ball joint.
- Elbow wall.
- Anti-limescale hand shower: Ø 110 mm.
- Shower hose SATIN.

Kit doccia ad incasso RAPID-BOX

Con chiusura e regolazione di portata.

- Corpo incassato incluso
- Doccia fissa acciaio inossidabile Ø 250 mm. con snodo.
- Supporto per doccia.
- Doccetta anticalcare: Ø 110 mm.
- Flessibile satin.

Podomítkový jednopákový sprchový set RAPID-BOX

s uzávěrem a regulací průtoku.

- Včetně podomítkového tělesa
- Pevná sprcha Ø 250 mm. s kloubem. Materiál nerez. oceli.
- Držák s nástěnným přívodem vody
- Ruční sprcha, proti usaz. vod. kamene. Ø 110 mm.
- Flexi hadice SATIN.



20428004

255,00

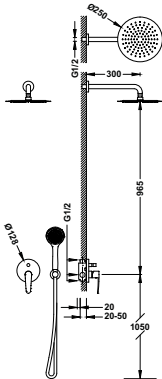

Concealed shower set

with water shut off and flow control.

- Built-in body included
- Fixed shower head Ø 250 mm. with ball joint. Stainless material.
- Elbow wall.
- Anti-limescale hand shower.
- Satin hose.

Kit doccia ad incasso

Con chiusura e regolazione di portata.

- Corpo incassato incluso
- Doccia fissa Ø 250 mm. con snodo. Materiale acciaio inossidabile.
- Supporto per doccia.
- Doccetta anticalcare.
- Flessibile satin.

Podomítkový jednopákový sprchový set

s uzávěrem a regulací průtoku.

- Včetně podomítkového tělesa
- Pevná sprcha Ø 250 mm. s kloubem. Materiál nerezová ocel.
- Držák s nástěnným přívodem vody.
- Ruční sprcha, proti usaz. vod. kamene.
- Flexi hadice SATIN.



20418004

255,00

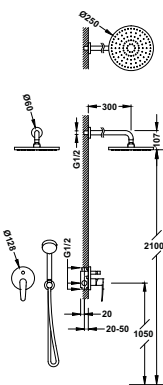

Concealed shower set

with water shut off and flow control.

- Built-in body included
- Fixed shower head Ø 250 mm. with ball joint.
- Elbow wall.
- Anti-limescale hand shower.
- Satin hose.

Kit doccia ad incasso

Con chiusura e regolazione di portata.

- Corpo incassato incluso
- Doccia fissa Ø 250 mm. con snodo.
- Supporto per doccia.
- Doccetta anticalcare.
- Flessibile satin.

Podomítkový jednopákový sprchový set

s uzávěrem a regulací průtoku.

- Včetně podomítkového tělesa
- Pevná sprcha Ø 250 mm. s kloubem.
- Držák s nástěnným přívodem vody.
- Ruční sprcha, proti usaz. vod. kamene.
- Flexi hadice SATIN.



20418002

255,00

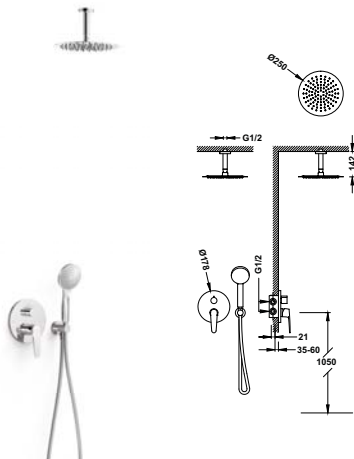
**Concealed shower set RAPID-BOX**

with water shut off and flow control.

- Built-in body included
- Fixed shower head Ø 250 mm. with ball joint. Stainless material.
- Elbow wall.
- Anti-limescale hand shower: Ø 110 mm.
- Satin hose.

Kit doccia ad incasso RAPID-BOX

Con chiusura e regolazione di portata.

- Corpo incassato incluso
- Doccia fissa Ø 250 mm. con snodo. Materiale acciaio inossidabile.
- Supporto per doccia.
- Doccetta anticalcare: Ø 110 mm.
- Flessibile satin.

Podomítkový jednopákový sprchový set RAPID-BOX

s uzávěrem a regulací průtoku.

- Včetně podomítkového tělesa
- Pevná sprcha Ø 250 mm. s kloubem. Materiál nerezová ocel.
- Držák s nástěnným přívodem vody.
- Ruční sprcha, proti usaz. vod. kamene: Ø 110 mm.
- Flexi hadice SATIN.



20428003

247,00

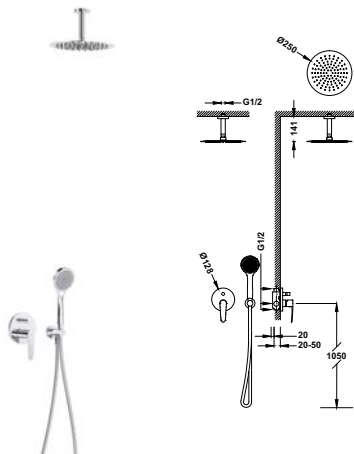
**Concealed shower set**

with water shut off and flow control.

- Built-in body included
- Fixed shower head Ø 250 mm. with ball joint. Stainless material.
- Elbow wall.
- Anti-limescale hand shower.
- Satin hose.

Kit doccia ad incasso

Con chiusura e regolazione di portata.

- Corpo incassato incluso
- Doccia fissa Ø 250 mm. con snodo. Materiale acciaio inossidabile.
- Supporto per doccia.
- Doccetta anticalcare.
- Flessibile satin.

Podomítkový jednopákový sprchový set

s uzávěrem a regulací průtoku.

- Včetně podomítkového tělesa
- Pevná sprcha Ø 250 mm. s kloubem. Materiál nerezová ocel.
- Držák s nástěnným přívodem vody.
- Ruční sprcha, proti usaz. vod. kamene: Ø 110 mm.
- Flexi hadice SATIN.



20418005

247,00

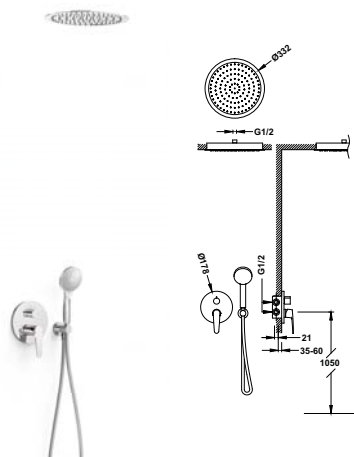
**Concealed shower set RAPID-BOX**

with water shut off and flow control.

- Built-in body included
- Ceiling shower antilime Ø 330 mm.
- Elbow wall.
- Anti-limescale hand shower: Ø 110 mm.
- Satin hose.

Kit doccia ad incasso RAPID-BOX

Con chiusura e regolazione di portata.

- Corpo incassato incluso
- Soffione doccia anticalcare Ø 330 mm.
- Supporto per doccia.
- Doccetta anticalcare: Ø 110 mm.
- Flessibile satin.

Podomítkový jednopákový sprchový set RAPID-BOX

s uzávěrem a regulací průtoku.

- Včetně podomítkového tělesa
- Stropní sprchové hrobitko Ø 330 mm.
- Držák s nástěnným přívodem vody.
- Ruční sprcha, proti usaz. vod. kamene: Ø 110 mm.
- Flexi hadice SATIN.



20428005

451,00

Concealed shower set RAPID-BOX

with water shut off and flow control.

- Built-in body included.
- Bath spout.
- Elbow wall.
- Anti-limescale hand shower \varnothing 110 mm.
- Shower hose SATIN.

Kit doccia ad incasso RAPID-BOX

Con chiusura e regolazione di portata.

- Corpo incassato incluso.
- Canna per vasca da bagno.
- Supporto per doccia.
- Doccetta anticalcare \varnothing 110 mm.
- Flessibile satin.

Podomítkový jednopákový sprchový set RAPID-BOX

s uzávěrem a regulací průtoku.

- Včetně podomítkového tělesa.
- Kohoutek pro vanu.
- Držák s nástěnným přívodem vody.
- Ruční sprcha, proti usaz. vod. Kamene \varnothing 110 mm.
- Flexi hadice SATIN.

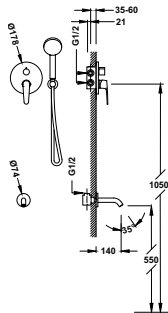

20428006

273,00

THERMOSTATICALLY-CONTROLLED | TERMOSTATICE | TERMOSTATICKÉ

Wall thermostatic shower mixer

Doccia termostatica

Termostatická sprchová baterie

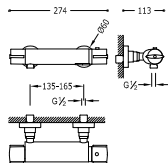

20419601

135,00

Wall thermostatic shower mixer

(Anti-limescale hand shower with directable support. Double interlocked shower hose).

Doccia termostatica

(Doccetta anticalcare con supporto orientabile. Flessibile doppia graffatura).

Termostatická sprchová baterie

(Ruční sprcha s nastavitelným držákem, proti usaz. vod. kamene a flexi hadice s dvojitým zámkem).

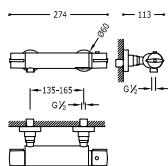

20419603

156,00

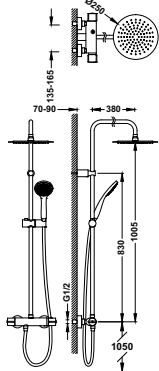

Wall thermostatic shower mixer

- Fixed shower head \varnothing 250 mm. with ball joint. Stainless material.
- Anti-limescale hand shower.
- Satin hose.
- Diverter integrated in the flow control.

Set doccia termostatica

- Doccia fissa \varnothing 250 mm. con snodo. Materiale acciaio inossidabile.
- Doccetta anticalcare.
- Flessibile satin.
- Invertitore integrato nel regolatore di portata.

Souprava termostatické sprchové baterie

- Pevná sprcha \varnothing 250 mm. s kloubem. Materiál nerezová ocel.
- Ruční sprcha, proti usaz. vod. Kamene.
- Flexi hadice SATIN.
- Přepínač zabudovaný v regulaci průtoku.



20438712

422,00

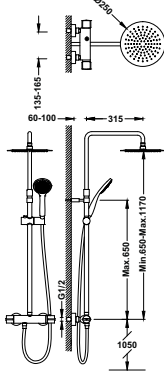

Wall thermostatic shower mixer

- Fixed shower head \varnothing 250 mm. with ball joint. Stainless material.
- Anti-limescale hand shower.
- Satin hose.
- Telescopic bar.
- Diverter integrated in the flow control.

Set doccia termostatica

- Doccia fissa \varnothing 250 mm. con snodo. Materiale acciaio inossidabile.
- Doccetta anticalcare.
- Flessibile satin.
- Asta telescopica.
- Invertitore integrato nel regolatore di portata.

Souprava termostatické sprchové baterie

- Pevná sprcha \varnothing 250 mm. s kloubem. Materiál nerezová ocel.
- Ruční sprcha, proti usaz. vod. Kamene.
- Flexi hadice SATIN.
- Teleskopická tyč.
- Přepínač zabudovaný v regulaci průtoku.



20438713

467,00

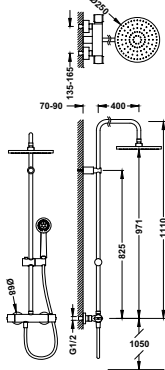

Wall thermostatic shower mixer

- Fixed shower head Ø 250 mm. with ball joint.
- Anti-limescale hand shower Ø 80 mm..
- Satin hose.
- Diverter integrated in the flow control.

Set doccia termostatica

- Doccia fissa Ø 250 mm. con snodo.
- Doccetta anticalcare Ø 80 mm..
- Flessibile satin.
- Invertitore integrato nel regolatore di portata.

Souprava termostatické sprchové baterie

- Pevná sprcha Ø 250 mm. s kĺubom.
- Ruční sprcha, proti usaz. vod. kamene Ø 80 mm..
- Flexi hadice SATIN.
- Prepínač zabudovaný v regulaci průtoku.



20438701

422,00

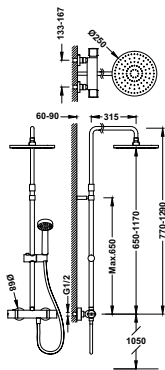

Wall thermostatic shower mixer

- Fixed shower head Ø 250 mm. with ball joint.
- Anti-limescale hand shower Ø 80 mm..
- Satin hose.
- Telescopic bar.
- Diverter integrated in the flow control.

Set doccia termostatica

- Doccia fissa Ø 250 mm. con snodo.
- Doccetta anticalcare Ø 80 mm..
- Flessibile satin.
- Asta telescopica.
- Invertitore integrato nel regolatore di portata.

Souprava termostatické sprchové baterie

- Pevná sprcha Ø 250 mm. s kĺubom.
- Ruční sprcha, proti usaz. vod. kamene Ø 80 mm..
- Flexi hadice SATIN.
- Teleskopická tyč.
- Prepínač zabudovaný v regulaci průtoku.



20438703

467,00

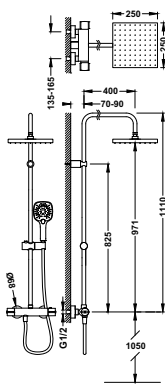

Wall thermostatic shower mixer

- Fixed shower head 250x250 mm. with ball joint.
- Anti-limescale hand shower 107x107 mm.
- Satin hose.
- Diverter integrated in the flow control.

Set doccia termostatica

- Doccia fissa 250x250 mm. con snodo.
- Doccetta anticalcare 107x107 mm.
- Flessibile satin.
- Invertitore integrato nel regolatore di portata.

Souprava termostatické sprchové baterie

- Pevná sprcha 250x250 mm. s kĺubom.
- Ruční sprcha, proti usaz. vod. kamene 107x107 mm.
- Flexi hadice SATIN.
- Prepínač zabudovaný v regulaci průtoku.



20438708

422,00

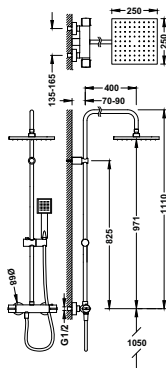
**Wall thermostatic shower mixer**

- Fixed shower head 250x250 mm. with ball joint.
- Anti-limescale hand shower 80x80 mm.
- Satin hose.
- Diverter integrated in the flow control.

Set doccia termostatica

- Doccia fissa 250x250 mm. con snodo.
- Doccetta anticalcare 80x80 mm.
- Flessibile satin.
- Invertitore integrato nel regolatore di portata.

Souprava termostatické sprchové baterie

- Pevná sprcha 250x250 mm. s kloubem.
- Ruční sprcha, proti usaz. vod. kamene 80x80 mm.
- Flexi hadice SATIN.
- Přepínač zabudovaný v regulaci průtoku.



20438702

422,00

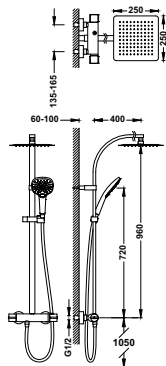
**Wall thermostatic shower mixer**

- Fixed shower head 250x250 mm. with ball joint. Stainless material.
- Anti-limescale hand shower (3 fonctions)
- Satin hose.
- Diverter integrated in the flow control.

Set doccia termostatica

- Doccia fissa 250x250 mm. con snodo. Materiale acciaio inossidabile.
- Doccetta anticalcare (3 funzioni).
- Flessibile satin.
- Invertitore integrato nel regolatore di portata.

Souprava termostatické sprchové baterie

- Pevná sprcha 250x250 mm. s kloubem. Materiál nerezová ocel.
- Ruční sprcha (3 funkce) proti usaz. vod. kamene
- Flexi hadice SATIN.
- Přepínač zabudovaný v regulaci průtoku.



20439503

514,00

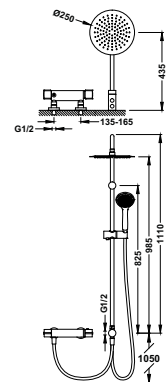
**Wall thermostatic shower mixer**

- Fixed shower head \varnothing 250 mm. with ball joint. Stainless material.
- Anti-limescale hand shower \varnothing 80 mm.
- Satin hose.

Set doccia termostatica

- Doccia fissa \varnothing 250 mm. con snodo. Materiale acciaio inossidabile.
- Doccetta anticalcare.
- Flessibile satin.

Souprava termostatické sprchové baterie

- Pevná sprcha \varnothing 250 mm. s kloubem. Materiál nerezová ocel.
- Ruční sprcha, proti usaz. vod. Kamene.
- Flexi hadice SATIN.



20438503

293,00

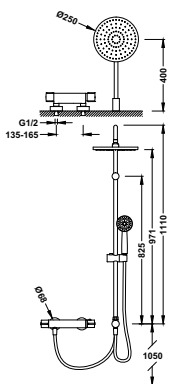

Wall thermostatic shower mixer

- Fixed shower head \varnothing 250 mm. with ball joint.
- Anti-limescale hand shower \varnothing 80 mm..
- Satin hose.

Set doccia termostatica

- Doccia fissa \varnothing 250 mm. con snodo.
- Doccetta anticalcare \varnothing 80 mm..
- Flessibile satin.

Souprava termostatické sprchové baterie

- Pevná sprcha \varnothing 250 mm. s kloubelem.
- Ruční sprcha, proti usaz. vod. kamene \varnothing 80 mm..
- Flexi hadice SATIN.



29919508

20438501

293,00

SHUTOFF VALVES | RUBINETTI DI ARRESTO | PRŮCHOZÍ VENTILY

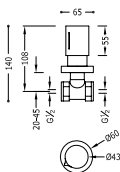

1/2" threaded-ends gate-valve

Rubinetto di arresto filettato 1/2"

Uzavírací ventil 1/2"

06115501

74,70

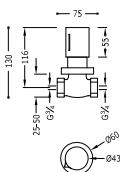

3/4" threaded-ends gate-valve

Rubinetto di arresto filettato 3/4"

Uzavírací ventil 3/4"

06151101

82,90

532 / **Kitchen mixer taps** | Cucina monocomando | Dřezové baterie s jednopákovým mechanismem



533 / **Kitchen taps with detachable spray nozzle** | Cucina con manico estraibile | Dřezová baterie s výsuvnou sprškou



535 / **For water treatment** | Per sistema di trattamento acqua | Dřezová baterie k úpravě vody



TRÉS

KITCHEN
CUCINA
KUCHYNĚ



www.qtr.es/kitchen



Chrome
Cromato
Chrom

KITCHEN MIXER TAPS | CUCINA MONOCOMANDO | DŘEZOVÉ BATERIE S JEDNOPÁKOVÝM MECHANISMEM

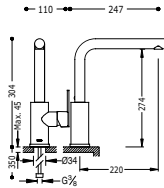

Single lever single hole sink mixer
 Monocomando lavello verticale
 Jednopáková dřezová kuchyňská baterie

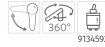

181436

180,00

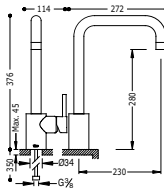

Single lever single hole sink mixer
 Monocomando lavello verticale
 Jednopáková dřezová kuchyňská baterie



162441

178,00

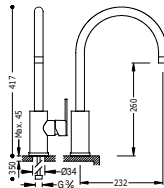

Single lever single hole sink mixer
 Monocomando lavello verticale
 Jednopáková dřezová kuchyňská baterie



181540

195,00

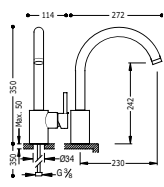

Single lever single hole sink mixer
 Monocomando lavello verticale
 Jednopáková dřezová kuchyňská baterie



162442

155,00

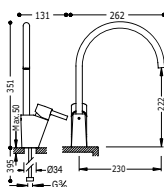

Single lever single hole sink mixer
 Monocomando lavello verticale
 Jednopáková dřezová kuchyňská baterie



183341

126,00

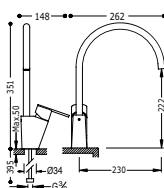

Single lever single hole sink mixer
 Monocomando lavello verticale
 Jednopáková dřezová kuchyňská baterie



181341

134,00

The lever is located at the exact point where the water comes out, eliminating contact between the water and the air and preventing contamination.

La chiusura è situata esattamente all'uscita dell'acqua, eliminando il contatto tra essa e l'aria ed evitando in questo modo la sua contaminazione.

Uzávěr je umístěn přímo u výstupu vody, čímž je zamezeno kontaktu vody se vzduchem a tím pádem její kontaminace.



Anti-chlorine filter Filtro anticloro Antichlorový filtr

According to the investigations carry out, the osmotized water is excessively lower in minerals, so it is not recommendable its daily consumption. The anti-chlorine TRES filter assure a low Chlorine index, taking out the nasty water taste but respecting the minerals property of mains water.

Second gli Studio realizzati, l'acqua osmotizzata, è eccessivamente bassa in minerali, ragione per cui non è raccomandabile per il consumo giornaliero. IL FILTRO ANTICLORO di TRES invece assicura un indice basso in Cloro, eliminando perciò il cattivo sapore dell'acqua, però rispettando le proprietà minerali dell'acqua della rete.

Z provedených výzkumů vyplývá, že osmotická voda je příliš ochuzena o minerály, což znamená, že není doporučována k běžnému užívání. ANTICHLOROVÝ FILTR od společnosti TRES zaručuje nízký obsah chloru a eliminuje zápach vody při zachování minerálních vlastností vody ze sítě.

538 / Sink timer tap | Rubinetto temporizzato per lavabo | Umyvadlová baterie s časovačem



539 / Sink electronic tap | Rubinetto elettronico per lavabo | Elektronická umyvadlová baterie



541 / Urinal timer tap | Rubinetto temporizzato per orinatoio | Písoárová baterie s časovačem



541 / Urinal electronic tap | Rubinetto elettronico per orinatoio | Elektronická písoárová baterie



542 / Shower timer tap | Rubinetto temporizzato per doccia | Sprchová baterie s časovačem



FITTED WITH TIMERS - ELECTRONIC
TEMPORIZZATE - ELETTRONICHE
S ČASOVAČEM - ELEKTRONICKÉ



www.qrtr.es/tempo-tres



www.qrtr.es/electronic-tres



Chrome
Cromato
Chrom

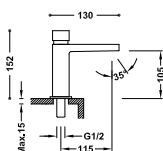

Single water temperature timer sink tap
Automatic shut-off at 6 seconds. Flow 6.5 l/min.

Lavabo temporizzato 1 acqua
Chiusura automatica a 6 sec. Flusso 6,5 l/min.

Umyvadlová baterie pro jednu vodu s časovým vypínačem
Automatické uzavření po uplynutí 6 s. Průtok 6,5 l/min.



2051201

101,00

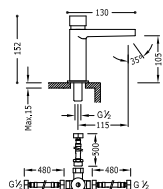

Mixer timer sink tap

Automatic shut-off at 6 seconds. NOTE: Includes a hot and cold mixer tap with flexible pipes (for Nr.: 19250730). Flow 6.5 l/min.

Lavabo temporizzato miscelatore
Chiusura automatica a 6 sec. NOTA: include un rubinetto miscelatore a due acque con tubi flessibili (per ref.: 19250730). Flusso 6,5 l/min.

Směšovací umyvadlová baterie
Automatické uzavření po uplynutí 6 s. POZNÁMKA: Obsahuje směsnou baterii pro teplou i studenou vodu s ohebnými hadicemi (Kód: 19250730). Průtok 6,5 l/min.



2051202

138,00

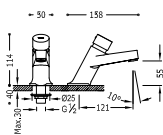

Single water temperature timer sink tap
Automatic shut-off at 6 seconds. Flow 6.5 l/min.

Lavabo temporizzato 1 acqua
Chiusura automatica a 6 sec. Flusso 6,5 l/min.

Umyvadlová baterie pro jednu vodu s časovým vypínačem
Automatické uzavření po uplynutí 6 s. Průtok 6,5 l/min.



01210303

81,40

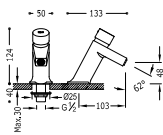

Single water temperature timer sink tap
Automatic shut-off at 6 seconds. Flow 6.5 l/min.

Lavabo temporizzato 1 acqua
Chiusura automatica a 6 sec. Flusso 6,5 l/min.

Umyvadlová baterie pro jednu vodu s časovým vypínačem
Automatické uzavření po uplynutí 6 s. Průtok 6,5 l/min.



01210302

77,25



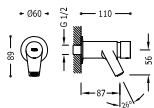

Tap for wall, washbasin
1/2" G. Automatic shut-off at 6 seconds. Flow 6.5 l/min.

Gruppo lavabo a muro
entrata 1/2" G. Maschio. Chiusura automatica a 6 sec. Flusso 6,5 l/min.

Nástěnná umyvadlová baterie
vnější závit 1/2" G. Automatické uzavření po uplynutí 6 s. Průtok 6,5 l/min.



01210002

66,95

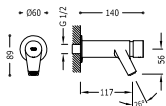

Tap for wall, washbasin
1/2" G. Automatic shut-off at 6 seconds. Flow 6.5 l/min.

Gruppo lavabo a muro
entrata 1/2" G. Maschio. Chiusura automatica a 6 sec. Flusso 6,5 l/min.

Nástěnná umyvadlová baterie
vnější závit 1/2" G. Automatické uzavření po uplynutí 6 s. Průtok 6,5 l/min.



01210003

71,10

SINK ELECTRONIC TAP | RUBINETTO ELETTRONICO PER LAVABO | ELEKTRONICKÁ UMYVADLOVÁ BATERIE

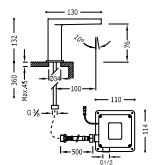

1 water electronic tap
Operated by an infrared sensor

Lavabo elettronico 1 acqua
Azionamento tramite sensore a infrarossi

Elektronická baterie na 1 vodu
Spouštěna snímačem infračerveného záření



20560301

281,00

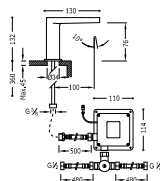

Electronic mixer tap
Operated by an infrared sensor. NOTE: Includes a hot and cold mixer tap with flexible pipes (for Nr.: 19250730).

Lavabo elettronico miscelatore
Azionamento tramite sensore a infrarossi. NOTA: include un rubinetto miscelatore a due acque con tubi flessibili (per ref.: 19250730).

Směšovací elektronická baterie
Spuštěna snímačem infračerveného záření. POZNÁMKA: Obsahuje směšnou baterii pro teplou i studenou vodu s ohebnými hadicemi (Kód: 19250730).



20560302

312,00

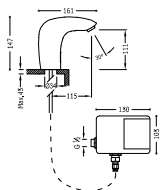

1 water electronic tap
Operated by an infrared sensor

Lavabo elettronico 1 acqua
Azionamento tramite sensore a infrarossi

Elektronická baterie na 1 vodu
spouštěno snímačem infračerveného záření



19250730

330,00

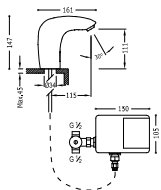

Electronic mixer tap
Operated by an infrared sensor. NOTE: Includes a hot and cold mixer tap with flexible pipes (for Nr.: 19250730).

Lavabo elettronico miscelatore
Azionamento tramite sensore a infrarossi. NOTA: include un rubinetto miscelatore a due acque con tubi flessibili (per ref.: 19250730).

Směšovací elektronická baterie
Spuštěna snímačem infračerveného záření. POZNÁMKA: Obsahuje směšnou baterii pro teplou i studenou vodu s ohebnými hadicemi (Kód: 19250730).



19290603

383,00

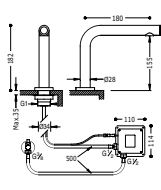

TOUCH-TRES 1 water electronic tap
Sensitive system to the touch. No press.

Lavabo elettronico 1 acqua TOUCH-TRES
Sistema sensibile al tatto. Senza premere.

Elektronická baterie na 1 vodu TOUCH-TRES
Dotyková. Pouze na dotek (NESMÍ se stisknout)



06144701

219,00

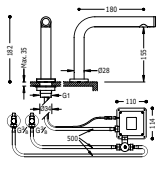

TOUCH-TRES electronic mixer tap
Sensitive system to the touch. No press. NOTE: Includes a hot and cold mixer tap with flexible pipes (for Nr.: 19250730).

Lavabo elettronico miscelatore TOUCH-TRES
Sistema sensibile al tatto. Senza premere. NOTA: include un rubinetto miscelatore a due acque con tubi flessibili (per ref.: 19250730).

Elektronická baterie směšná TOUCH-TRES
Dotyková. Pouze na dotek (NESMÍ se stisknout). POZNÁMKA: Obsahuje směšnou baterii pro teplou i studenou vodu s ohebnými hadicemi (Kód: 19250730).



06144801

265,00

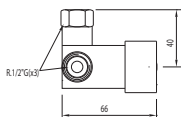

Two-water mixer WITH FLEXIBLE PIPES
(TRESTRONIC, TOUCH-TRES, TEMPO-TRES)
Miscelatore due acque CON TUBI FLESSIBILI
(TRESTRONIC, TOUCH-TRES, TEMPO-TRES)

Směšovač na dvě vody S FLEXIBILNÍMI TRUBKAMI
pro umyvadlové baterie TRESTRONIC, TOUCH-TRES a TEMPO-TRES

19250730

62,75

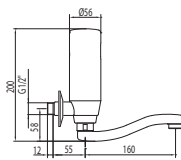

1 water electronic tap
Lavabo elettronico 1 acqua
Elektronická baterie na 1 vodu



09217101

263,00

URINAL TIMER TAP | RUBINETTO TEMPORIZZATO PER ORINATOIO | PISOÁROVÁ BATERIE S ČASOVAČEM

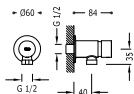

Urinal tap
Automatic shut-off at 6 seconds. Flow 6.5 l/min.

Gruppo da urinatoio
Chiusura automatica a 6 sec. Flusso 6,5 l/min.

Baterie pro pisoár
Automatické uzavření po uplynutí 6 s. Průtok 6,5 l/min.



01220002

60,80

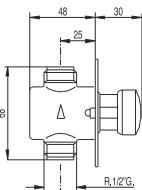

Urinal tap
1/2" G.

Gruppo da urinatoio
entrata 1/2" G. Maschio

Baterie pro pisoár podomítková
vnější závit 1/2" G.

01220801

68,50

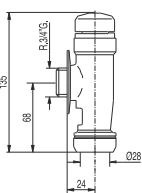

Toilet flush button
3/4" G. thread plug cock intel. Outlet for 26x28 pipe. Flow 1.5 l/min.

Fluxor per water
entrata filettatura maschio 3/4"G. Uscita per tubi 26x28 1,5 l/m.

Splachovač pro WC
vstup vnější závit 3/4" G. Výstup pro trubku 26x28. Průtok 1,5 l/min.

112205

90,05

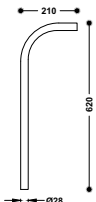

Flush tube for urinal tap

Tubo scarico
Splachovací trubka pro WC automat

13420503

49,45

URINAL ELECTRONIC TAP | RUBINETTO ELETTRONICO PER ORINATOIO | ELEKTRONICKÁ PISOÁROVÁ BATERIE

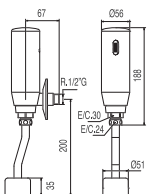

Electronic view urinary tap
with two adaptable tubes to urinary

Rubinetto scarico elettronico per urinatoio
con due tubi adattabili a urinatoio

Elektronická nekrytá pisoárová baterie
s dvěma trubkami přípusobitelnými na pisoár



112206

258,00

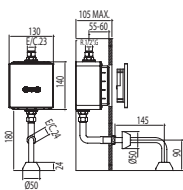

Electronic concealed urinary tap

Rubinetto scarico elettronico per urinatoio

Elektronická vestavěná baterie pro pisoár



01220701

238,00

SHOWER TIMER TAP | RUBINETTO TEMPORIZZATO PER DOCCIA | SPRCHOVÁ BATERIE S ČASOVAČEM

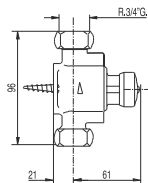

Shower tap

outer feeding by means of lower part. Intel and outlet with nut and joint for 13x15 pipe. Automatic shut-off at 15 seconds. Flow 16 l/min.

Gruppo doccia

alimentazione esteriore per parte inferiore entrata e uscita con filettatura e giunto per tubo 13x15 16 l/m.

Sprchová baterie

vnější přítok spodem, vstup a výstup s maticí a těsněním pro trubici 13x15. Automatické uzavření po uplynutí 15 s. Průtok 16 l/min.

112167

90,90

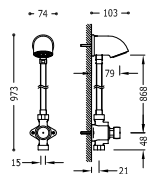

Shower unit

exterior feed from the bottom, with nut and joint for a 13x15 pipe and automatic flow regulator incorporated: 8-10 l/min.

Set doccia rubinetto piu vaporizzatore
8-10 l/m.

Sprchová souprava

vnější napájení přes spodní část, s maticí a těsněním pro trubici 13x15 a zabudovaný automatický regulátor průtoku: 8-10 l/m

112161

200,00

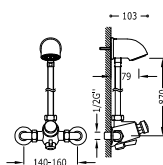

Mixer assembly for shower

Opposing inlets with extendable fittings. Automatic flow regulator incorporated in the sprinkler. Anti-return valves at the inlets. Flow 8-10 l/min.

Set miscelatore per doccia

entrata opposta con raccordi estensibili. Regolatore automatico di portata incorporato nel vaporizzatore. Valvola antiritorno in entrata. 8-10 l/m.

Směšovací souprava pro sprchu

protilehlé vstupy s nastavitelnými převlečnými maticemi. Automatická regulace průtoku zabudovaná do křepítka. U vstupů ventily proti zpětnému toku vody. 8-10 l/min

112163

394,00

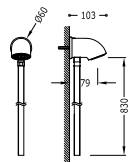

Tube with shower sprayer

Automatic flow regulator incorporated in the sprinkler. Flow 8-10 l/min.

Soffione piu tubo

Regolatore automatico di portata incorporato nel vaporizzatore. 8-10 l/m.

Křepítko + trubka

Automatická regulace průtoku zabudovaná do křepítka. Průtok 8-10 l/min.

11216150

111,00

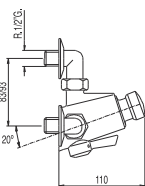

Mixer tap for shower
Flow 16 l/min.

Gruppo miscelatore per doccia
Entrata opposta e uscita verticale Equipaggiato con 3 raccordi estensibili 16 l/m.

Sprchová směšovací baterie
protilehlé vstupy a svislý výstup. Vybavena 3 nastavitelnými převlečnými maticemi. U vstupů ventily proti zpětnému toku vody. Průtok 16 l/min.

112162 384,00

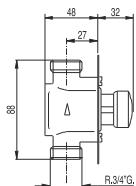

Shower taps
For recessing, intel and outlet with 3/4" G thread plug cock. Flow 20 l/min.

Gruppo doccia ad incasso
Entrata e uscita con madrevite maschio 3/4 " G. 20 l/min.

Sprchová baterie podomítková
vstup a výstup s vnějším závětem 3/4" G. Průtok 20 l/min.

112178 79,80

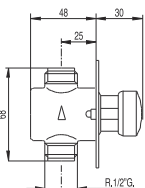

Shower taps
For recessing, intel and outlet with 1/2" G thread plug cock. Flow 16 l/min.

Gruppo doccia ad incasso
Entrata e uscita con madrevite maschio 1/2 " G. 16 l/min.

Sprchová baterie podomítková
vstup a výstup s vnějším závětem 1/2" G. Průtok 16 l/min.

112177 68,50

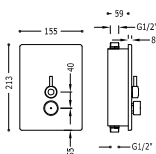

Mixer tap for shower
with 2 water inlets
Gruppo miscelatore per doccia
con 2 ingressi d'acqua

Sprchová směšovací baterie, protilehlé vstupy a svislý výstup.
se 2 vstupy vody

01217901 410,00

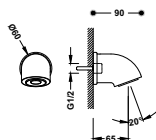

Anti-vandalism shower head
with automatic flow regulator 6 l/min.

Soffione antivandalico
6 l/min.

Kropítko v provedení proti poškození vandaly
s automatickým regulátorem průtoku 6 l/min.

13416803 87,90

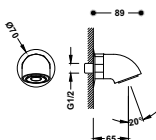

Shower sprayer
with automatic flow regulator. R 1/2" G.

Soffione per doccia
R 1/2" G.

Sprchové kropítko, s automatickou regulací průtoku
s automatickým regulátorem průtoku. Závět 1/2" G.

13416703 68,35

548 / Bidets WC | Bidet WC | Bidety WC



TRÉS

BIDETS WC
BIDET WC
BIDETY WC



www.qtrr.es/special-tres



Chrome
Cromato
Chrom

Replaces the bidet and makes good use of space

Sostituire il bidet e approfittate dello spazio

Nahradte bidet a využijte prostoru

Replaces the traditional bidet with a tap that takes advantage of the toilet bowl. Simple to install, and does not occupy any space. You can opt for an embedded mixer tap with integrated shower/bidet support, or else use the wash basin tap with a specific outlet for the shower-bidet. Two options to adapt to new spaces and bring your bathroom up to date.

Sostituisci il bidet tradizionale con un rubinetto da incorporare nel water. L'installazione è semplice e non occupa spazio. Si può scegliere un rubinetto monocomando incassato con supporto per doccia/bidet incorporato o utilizzare il rubinetto del lavandino con apposita uscita per la doccia/bidet. Due opzioni da adattare ai nuovi spazi per riformulare l'arredo bagno.

Vyměňte tradiční bidet za ruční bidetovou spršku využívající WC nádržku. Instalace je snadná a zařízení nezabírá místo. Existují dvě řešení: jednopákové podomítkové řešení s integrovaným držákem bidetové spršky nebo umyvadlová baterie se zvláštním výstupem pro bidetovou spršku. Dvě možnosti, jak se přizpůsobit novému prostředí a zmodernizovat toaletu.



- ① **Built-in mixer tap with integrated shower-bidet support.** / Monocomando miscelatore incassato con supporto doccia-bidet integrato. / Vestavěná jednopáková směšovací baterie s integrovaným držákem sprchy-bidetu.
- ② **Special bathroom mixer tap with a dedicated shower-bidet outlet; easy to install using the water outlet shared with the sink mixer tap.** / Monocomando speciale da lavabo con un'uscita specifica per la doccia-bidet: installazione semplice utilizzando la presa d'acqua condivisa con il monocomando del lavabo. / Speciální jednopáková umyvadlová baterie s jedním specifickým výstupem pro sprchu/bidet; snadná instalace s využitím společného přívodu vody pro jednopákovou umyvadlovou baterii.

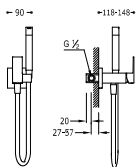

BIDETS | BIDET | BIDETY

**Concealed single lever bidet/toilets****Left or right support, interchangeable. Sateen hose.****Monocomando ad incasso per bidé WC****Supporto a destra o a sinistra, intercambiabile. Flesso satinato.***Jednopávková podomítková baterie pro bidet WC**Vyměnitelný držák zprava či zleva. Sprchová mosazná baterie s omezovacím hrdlem 5 l/m. Systém proti kapání a flexi hadice SATIN*

9130190

00612301

170,00

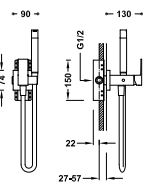
**Concealed single lever bidet/toilets****Left or right support, interchangeable. Sateen hose. Optie gips****Monocomando ad incasso per bidé WC****Supporto a destra o a sinistra, intercambiabile. Flesso satinato. Opzione Cartongesso***Jednopávková podomítková baterie pro bidet WC**Vyměnitelný držák zprava či zleva. Sprchová mosazná baterie s omezovacím hrdlem 5 l/m. Systém proti kapání a flexi hadice SATIN. Možnost pro sádrokartonové panely*

9130190

00612302

207,00

**Accessory towel racks****180 mm. (for Nr.: 00612301, 00612302). NOTE: Left or right support, interchangeable.****Accessori portasciugamani****180 mm. (per ref.: 00612301, 00612302). NOTA: Supporto a destra o a sinistra, intercambiabile.***Přislušenství držák na ručníky**180 mm. (Kód: 00612301, 00612302). POZNÁMKA: Pravý nebo levý podstavec, vyměnitelný.*

03412402

39,95

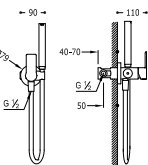
**Concealed single lever bidet/toilets****Left or right support, interchangeable. Sateen hose.****Monocomando ad incasso per bidé WC****Supporto a destra o a sinistra, intercambiabile. Flesso satinato.***Jednopávková podomítková baterie pro bidet WC**Vyměnitelný držák zprava či zleva. Sprchová mosazná baterie s omezovacím hrdlem 5 l/m. Systém proti kapání a flexi hadice SATIN*

9134591

20522301

158,00

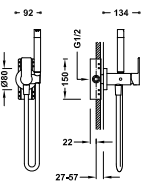
**Concealed single lever bidet/toilets****Left or right support, interchangeable. Sateen hose. Optie gips****Monocomando ad incasso per bidé WC****Supporto a destra o a sinistra, intercambiabile. Flesso satinato. Opzione Cartongesso***Jednopávková podomítková baterie pro bidet WC**Vyměnitelný držák zprava či zleva. Sprchová mosazná baterie s omezovacím hrdlem 5 l/m. Systém proti kapání a flexi hadice SATIN. Možnost pro sádrokartonové panely*

9134591

20522201

195,00

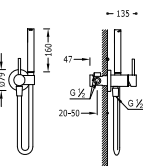
**Concealed single lever bidet/toilets****Left or right support, interchangeable. Sateen hose.****Monocomando ad incasso per bidé WC****Supporto a destra o a sinistra, intercambiabile. Flesso satinato.***Jednopávková podomítková baterie pro bidet WC**Vyměnitelný držák zprava či zleva. Sprchová mosazná baterie s omezovacím hrdlem 5 l/m. Systém proti kapání a flexi hadice SATIN*

9134591

134123

159,00

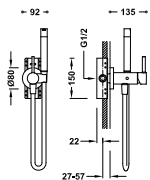

Concealed single lever bidet/toilets
Left or right support, interchangeable. Sateen hose. Optie gips

Monocomando ad incasso per bidé WC
 Supporto a destra o a sinistra, intercambiabile. Flesso satinato. Opzione Cartongesso

Jednopáková podomítková baterie pro bidet WC
 Vyměnitelný držák zprava či zleva. Sprchová mosazná baterie s omezovacím hrdlem 5 l/m. Systém proti kapání a flexi hadice SATIN. Možnost pro sádrokartonové panely



134122

199,00

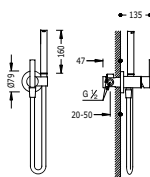

Concealed single lever bidet/toilets
Left or right support, interchangeable. Sateen hose.

Monocomando ad incasso per bidé WC
 Supporto a destra o a sinistra, intercambiabile. Flesso satinato.

Jednopáková podomítková baterie pro bidet WC
 Vyměnitelný držák zprava či zleva. Sprchová mosazná baterie s omezovacím hrdlem 5 l/m. Systém proti kapání a flexi hadice SATIN



181223

158,00

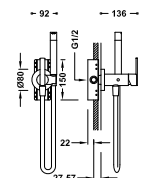

Concealed single lever bidet/toilets
Left or right support, interchangeable. Sateen hose. Optie gips

Monocomando ad incasso per bidé WC
 Supporto a destra o a sinistra, intercambiabile. Flesso satinato. Opzione Cartongesso

Jednopáková podomítková baterie pro bidet WC
 Vyměnitelný držák zprava či zleva. Sprchová mosazná baterie s omezovacím hrdlem 5 l/m. Systém proti kapání a flexi hadice SATIN. Možnost pro sádrokartonové panely



181222

195,00



Accessory towel racks

180 mm. (for Nr.: 134122, 134123, 181122, 181123, 181222, 181223, 20522201, 20522301). NOTE: Left or right support, interchangeable.

Accessori portasciugamani

180 mm. (per ref.: 134122, 134123, 181122, 181123, 181222, 181223, 20522201, 20522301). NOTA: Supporto a destra o a sinistra, intercambiabile.

Příslušenství držák na ručníky

180 mm. (Kód: 134122, 134123, 181122, 181123, 181222, 181223, 20522201, 20522301). POZNÁMKA: Právý nebo levý podstavec, vyměnitelný.

03412401

32,00



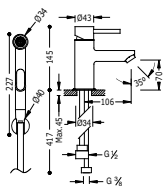

Concealed single lever bidet/toilets Rotating spout satin hose

Monocomando ad incasso per bidé WC
Canna girevole e Flessibile satin

*Jednopáková baterie pro umyvadlo na WC
Sprška s uzávěrem a flexi hadice SATIN*



913459210

162113

167,00

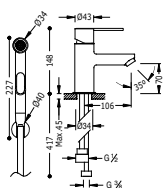

Concealed single lever bidet/toilets Rotating spout satteen hose

Monocomando lavabo per bidé WC
Canna girevole e flessio satinato

*Jednopáková baterie pro umyvadlo na WC
Sprška s uzávěrem a flexi hadice SATIN*



913459210

181113

164,00

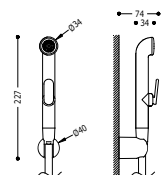

Bidet shower kit

Rotating spout, satteen hose and shower bar holder. Attention:
Spare part for bidet ref. 162113 and 181113 only.

Kit doccia bidet

Canna girevole, flessio satinato e supporto fisso parete.

Attenzione: Ricambio previsto solo per bidé rif.: 162113 e 181113.

Bidet sprcha kit

Nástavec ruční sprchy s tlačítkem uzavírajícím vodní proud, hadice satin a pevný nástěnný držák. Upozornění: Náhradní díl pouze pro bidet artikl č. 162113 a 181113.

29995001

30,80





554 / **Sliding bar** | *Asta antiscivolo* | *Posuvná tyč*



557 / **Shower kits** | *Kit per doccia* | *Sprchové soupravy*



567 / **Showers** | *Doccia* | *Sprchy*



569 / **Jets** | *Bocchette* | *Stimulační trysky* *Jets*



572 / **Hoses** | *Flessibili* | *Hadice*



575 / **Supports** | *Supporti* | *Podstavce*



577 / **Elbows** | *Gomiti* | *Kolena*



578 / **Other** | *Portasapone* | *Ostatní*



SHOWER PROGRAMME
PROGRAMMA PER DOCCE
SPRCHOVÝ PROGRAM



www.qtr.es/shower-complements



Chrome
Cromato
Chrom

SLIDING BAR | ASTA ANTISCIVOLO | POSUVNÁ TYČ

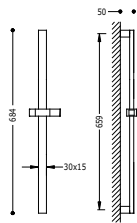
**Sliding bar****Brass long. 659 mm.****Asta antiscivolo****Ottone lungo 659 mm.***Posuvná tyč**Materiál Mosaz, dĺžka 659 mm*

134516

59,40

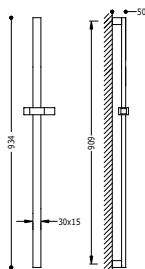
**Sliding bar****Brass long. 909 mm.****Asta antiscivolo****Ottone lungo 909 mm.***Posuvná tyč**Materiál Mosaz, dĺžka 909 mm*

134517

92,35

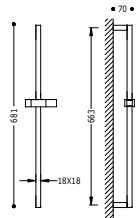
**Sliding bar****Brass long. 663 mm.****Asta antiscivolo****Ottone lungo 663 mm.***Posuvná tyč**Materiál Mosaz, dĺžka 663 mm*

107922

59,35

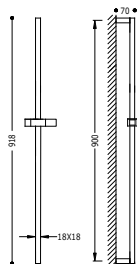
**Sliding bar****Brass long. 900 mm.****Asta antiscivolo****Ottone lungo 900 mm.***Posuvná tyč**Materiál Mosaz, dĺžka 900 mm*

134520

92,35

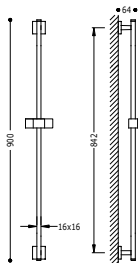

Sliding bar
Brass long. 842 mm.

Asta antiscivolo
 Ottone lungo 842 mm.

Posuvná tyč
 Materiál Mosaz, délka 842 mm

107935

121,00

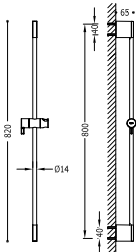

Sliding bar
Ø 14 mm. long. 800 mm.

Asta antiscivolo
 Ø 14 mm. Longo 800 mm.

Posuvná tyč
 Ø 14 mm, délka 800 mm

03463701

74,60

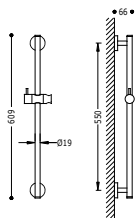

Sliding bar
Ø 19 mm. long. 550 mm.

Asta antiscivolo
 Ø 19 mm. Longo 550 mm.

Posuvná tyč
 Ø 19 mm, délka 550 mm

134618

44,45

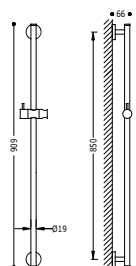

Sliding bar
Ø 19 mm. long. 850 mm.

Asta antiscivolo
 Ø 19 mm. Longo 850 mm.

Posuvná tyč
 Ø 19 mm, délka 850 mm

134619

62,25

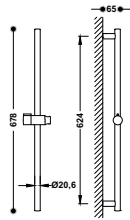

Sliding bar
 Ø 20,6 mm. long. 624 mm.

Asta antiscivolo
 Ø 20,6 mm. Longo 624 mm.

Posuvná tyč
 Ø 20,6 mm, délka 624 mm

03463702

56,00

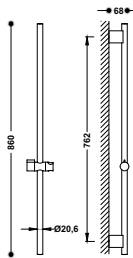

Sliding bar
 Ø 20,6 mm. long. 762 mm.

Asta antiscivolo
 Ø 20,6 mm. Longo 762 mm.

Posuvná tyč
 Ø 20,6 mm, délka 762 mm

03463708

83,85



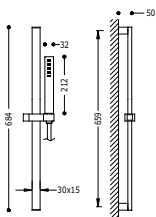

Bar-shower antilime
Brass long. 659 mm. Satin hose

Kit anticalcare
Ottone lungo 659 mm. Flessibile satin

Sprchová souprava, proti usaz. vod. kamene
Materiál Mosaz, délka 659 mm Flexi hadice SATIN



03452602

107,00

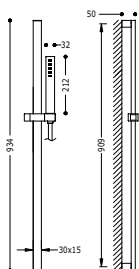

Bar-shower antilime
Brass long. 909 mm. Satin hose

Kit anticalcare
Ottone lungo 909 mm. Flessibile satin

Sprchová souprava, proti usaz. vod. kamene
Materiál Mosaz, délka 909 mm Flexi hadice SATIN



03452702

144,00

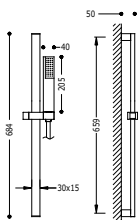

Bar-shower antilime
Brass long. 659 mm. Satin hose

Kit anticalcare
Ottone lungo 659 mm. Flessibile satin

Sprchová souprava, proti usaz. vod. kamene
Materiál Mosaz, délka 659 mm Flexi hadice SATIN



134526

92,35

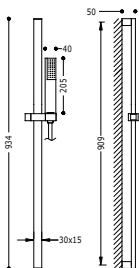

Bar-shower antilime
Brass long. 909 mm. Satin hose

Kit anticalcare
Ottone lungo 909 mm. Flessibile satin

Sprchová souprava, proti usaz. vod. kamene
Materiál Mosaz, délka 909 mm Flexi hadice SATIN



134527

125,00

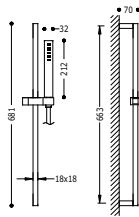

Bar-shower antilime

Brass long. 663 mm. Satin hose

Kit anticalcare

Ottone lungo 663 mm. Flessibile satin

Sprchová souprava, proti usaz. vod. kamene

Materiál Mosaz, dĺžka 663 mm Flexi hadice SATIN



03433603

107,00

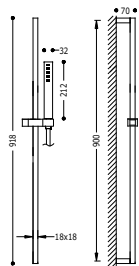

Bar-shower antilime

Brass long. 900 mm. Satin hose

Kit anticalcare

Ottone lungo 900 mm. Flessibile satin

Sprchová souprava, proti usaz. vod. kamene

Materiál Mosaz, dĺžka 900 mm Flexi hadice SATIN



03433604

144,00

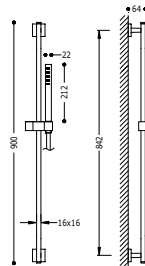

Bar-shower antilime

Brass long. 842 mm. Satin hose

Kit anticalcare

Ottone lungo 842 mm. Flessibile satin

Sprchová souprava, proti usaz. vod. kamene

Materiál Mosaz, dĺžka 842 mm. Flexi hadice SATIN



107934

179,00

607934

297,00

407934

297,00

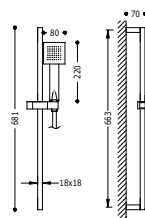

Bar-shower antilime

Brass long. 663 mm. Satin hose

Kit anticalcare

Ottone lungo 663 mm. Flessibile satin

Sprchová souprava, proti usaz. vod. kamene

Materiál Mosaz, dĺžka 663 mm Flexi hadice SATIN



134512

92,35

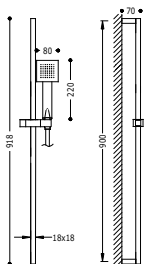

Bar-shower antilime
Brass long. 900 mm. Satin hose

Kit anticalcare
Ottone longo 900 mm. Flessibile satin

Sprchová souprava, proti usaz. vod. kamene
Materiál Mosaz, délka 900 mm Flexi hadice SATIN



134522

125,00

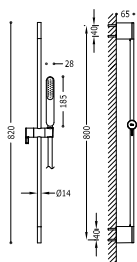

Bar-shower antilime set
Ø 14 mm. long. 800 mm. Satin hose

Kit anticalcare
Ø 14 mm. Longo 800 mm. Flessibile satin

Sprchová souprava, proti usaz. vod. kamene
Ø 14 mm, délka 800 mm Flexi hadice SATIN



03433601

124,00

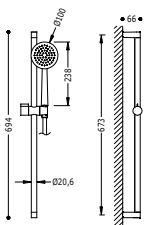

Bar-shower antilime
Ø 20,6 mm. Long. 673 mm. Satin hose

Kit anticalcare
Ø 20,6 mm. Longo 673 mm. Flessibile satin

Sprchová souprava, proti usaz. vod. kamene
Ø 20,6 mm, délka 673 mm. Flexi hadice SATIN

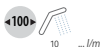

03463707

53,85

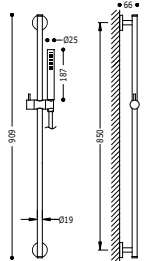

Sliding bar
Ø 19 mm. long. 850 mm. Satin hose

Asta antiscivolo
Ø 19 mm. Longo 850 mm. Flessibile satin

Sprchová sada
Ø 19 mm, délka 850 mm Flexi hadice SATIN



03462902

107,00

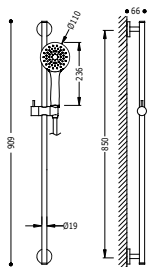

Sliding bar
 Ø 19 mm. long. 850 mm. Satin hose

Asta antiscivolo
 Ø 19 mm. Longo 850 mm. Flessibile satin

Sprchová sada
 Ø 19 mm, délka 850 mm Flexi hadice SATIN



06192801

102,00

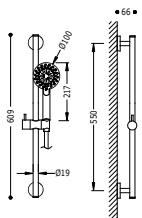

Bar-shower set
 Ø 19 mm. Longo 550 mm. Satin hose

Kit
 Ø 19 mm. Longo 550 mm. Flessibile satin

Sprchová sada
 Ø 19 mm, délka 550 mm Flexi hadice SATIN



134628

106,00

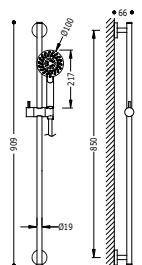

Bar-shower set
 Ø 19 mm. Long. 850 mm. Satin hose

Kit
 Ø 19 mm. Longo 850 mm. Flessibile satin

Sprchová sada
 Ø 19 mm, délka 850 mm Flexi hadice SATIN



134629

122,00

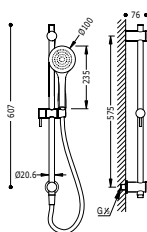

Sliding bar
 Ø 20,6 mm. Long. 575 mm. Satin hose. With wall entrance

Asta antiscivolo
 Ø 20,6 mm. Longo 575 mm. Flessibile satin. Con presa a parete

Sprchová sada
 Ø 20,6 mm, délka 575 mm Flexi hadice SATIN s nástěnným přívodem



06193103

113,00

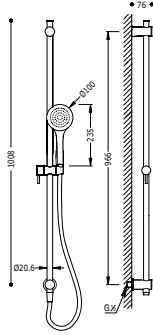

Sliding bar

Ø 20,6 mm. Long. 966 mm. Satin hose. With wall entrance

Asta antiscivolo

Ø 20,6 mm. Longo 966 mm. Flessibile satin. Con presa a parete

Sprchová sada

Ø 20,6 mm, délka 966 mm Flexi hadice SATIN s nástěnným přívodem

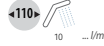

06193105

133,00

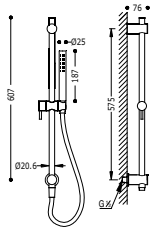

Sliding bar

Ø 20,6 mm. Long. 575 mm. Satin hose. With wall entrance

Asta antiscivolo

Ø 20,6 mm. Longo 575 mm. Flessibile satin. Con presa a parete

Sprchová sada

Ø 20,6 mm, délka 575 mm Flexi hadice SATIN s nástěnným přívodem



06193102

117,00

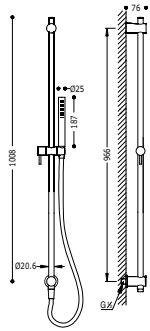

Sliding bar

Ø 20,6 mm. Long. 966 mm. Satin hose. With wall entrance

Asta antiscivolo

Ø 20,6 mm. Longo 966 mm. Flessibile satin. Con presa a parete

Sprchová sada

Ø 20,6 mm, délka 966 mm Flexi hadice SATIN s nástěnným přívodem



06193104

137,00

LARGE-SIZE SHOWER KITS | KIT PER DOCCIA GRANDE FORMATO | SPRCHOVÉ SOUPRAVY VELKÝCH ROZMĚRŮ

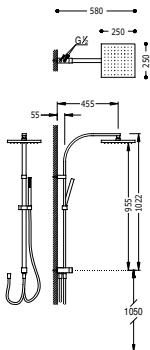
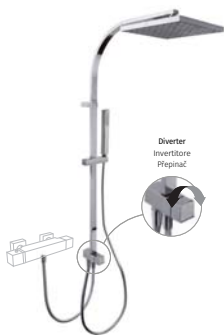

Bar-shower set

Fixed shower head 250x250 mm. Anti-limescale hand shower and sateen hose. Adaptable to a bath and shower mixer

Set monocomando con doccia

Doccia fissa 250x250 mm. Doccetta anticalcare e flessibile satin

Sprchová souprava, proti usaz. vod. kamene

Pevná sprcha 250x250 mm. Flexi hadice SATIN. Ruční sprcha, proti usaz. vod. kamene. Přizpůsobitelná na celek baterie sprchy a vany-sprchy



107926

319,00

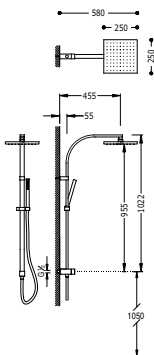

Bar-shower set

Fixed shower head 250x250 mm. Anti-limescale hand shower and sateen hose. With wall entrance

Set monocomando con doccia

Doccia fissa 250x250 mm. Douchette anticalcaire e flessibile satin. Con presa a parete

Sprchová souprava, proti usaz. vod. kamene

Pevná sprcha 250x250 mm. Ruční sprcha, proti usaz. vod. kamene. Flexi hadice SATIN. S nástěnným přívodem



107131

319,00

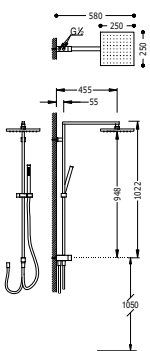
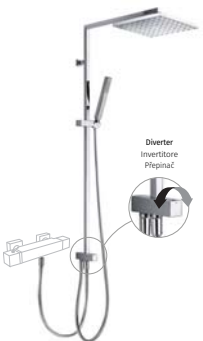

Bar-shower set

Fixed shower head 250x250 mm. Anti-limescale hand shower and sateen hose. Adaptable to a bath and shower mixer

Set monocomando con doccia

Doccia fissa 250x250 mm. Doccetta anticalcare e flessibile satin

Sprchová souprava, proti usaz. vod. kamene

Pevná sprcha 250x250 mm. Flexi hadice SATIN. Ruční sprcha, proti usaz. vod. kamene. Přizpůsobitelná na celek baterie sprchy a vany-sprchy



107476

323,00

Bar-shower set

Fixed shower head \varnothing 250 mm. Massage hand shower \varnothing 100 mm. (5 fonctions) and sateen hose. Adaptable to a bath and shower mixer

Set monocomando con doccia
Doccia fissa \varnothing 250 mm. Doccetta \varnothing 100 mm. (5 funzioni).

Sprchová tyč

Pevná sprcha \varnothing 250 mm. Flexi hadice SATIN. Ruční masážní sprcha \varnothing 100 mm. (5 funkcí). Přizpůsobitelná na celek baterie sprchy a vany-sprchy

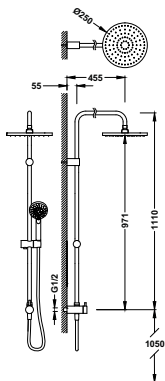

161475

217,00

Bar-shower set

Fixed shower head \varnothing 250 mm. Massage hand shower \varnothing 100 mm. (5 fonctions) and sateen hose. With wall entrance

Set monocomando con doccia
Doccia fissa \varnothing 250 mm. Doccetta \varnothing 100 mm. (5 funzioni). Flessibile satin. Con presa a parete

Sprchová tyč

Pevná sprcha \varnothing 250 mm. Flexi hadice SATIN. Ruční masážní sprcha \varnothing 100 mm. (5 funkcí). S nástěnným přívodem

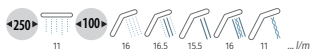
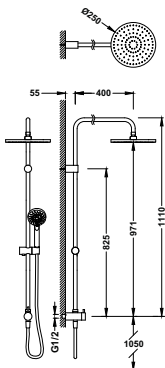

06163505

217,00

Bar-shower massage set

Fixed shower head \varnothing 250 mm. Massage hand shower \varnothing 100 mm. (5 fonctions) and sateen hose. Adaptable to a bath and shower mixer

Kit massaggi
Doccia fissa \varnothing 250 mm. Doccetta \varnothing 100 mm. (5 funzioni) e flessibile satin.

Tyč pro masážní sprchu

Pevná sprcha \varnothing 250 mm. Flexi hadice SATIN. Ruční masážní sprcha \varnothing 100 mm. (5 funkcí). Přizpůsobitelná na celek baterie sprchy a vany-sprchy

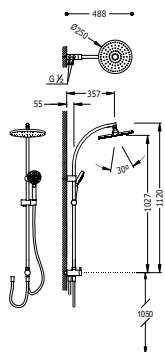

161476

278,00

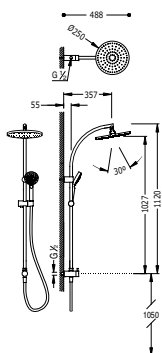

Bar-shower massage set
Fixed shower head Ø 250 mm. Massage hand shower Ø 100 mm.
(5 positions) and sateen hose. With wall entrance

Set doccia massaggio
Doccia fissa Ø 250 mm. Doccetta massaggiò Ø 100 mm
(5 posizioni). Flessibile satin. Con presa a parete

Tyč pro masážní sprchu
Pevná sprcha Ø 250 mm. Flexi hadice SATIN. Ruční masážní sprcha
Ø 100 mm (5 funkcí). S nástěnným přívodem

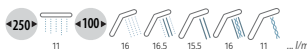

06163504

278,00

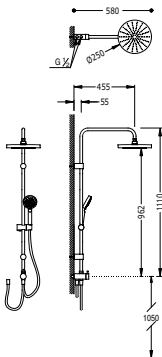

Bar-shower set
Sliding wall holder. Fixed shower head Ø 250 mm. Massage hand
shower Ø 100 mm (5 positions). Sateen hose. Adaptable to a bath
and shower mixer.

Set doccia
Barra e supporti parete regolabili. Doccia fissa Ø 250 mm.
Doccetta massaggiò Ø 100 mm (5 posizioni). Flessibile satin.

Sprchová souprava, proti usaz. vod. kamene
Posuvná tyč na nástěnných držácích. Pevná sprcha Ø 250 mm.
Ruční masážní sprcha Ø 100 mm (5 funkcí). Flexi hadice SATIN.
Přizpůsobitelná na celek baterie sprchy a vany-sprchy.



161214

303,00

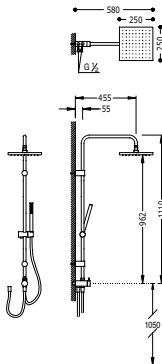

Bar-shower set
Sliding wall holder. Fixed shower head 250x250 mm.
Anti-limescale shower. Sateen hose. Adaptable to a bath and
shower mixer.

Set doccia
Barra e supporti parete regolabili. Doccia fissa 250x250 mm.
Doccetta anticalcare. Flessibile satin.

Sprchová souprava, proti usaz. vod. kamene
Posuvná tyč na nástěnných držácích. Pevná sprcha 250x250 mm.
Sprcha, proti usaz. vod. kamene. Flexi hadice SATIN. Přizpůsobitelná
na celek baterie sprchy a vany-sprchy.



06163506

329,00

Bar-shower set

Sliding wall holder. Fixed shower head \varnothing 300 mm. Brass. Massage hand shower \varnothing 100 mm (5 positions). Sateen hose. Adaptable to a bath and shower mixer.

Set doccia

Barra e supporti parete regolabili. Doccia fissa \varnothing 300 mm. Ottone. Doccetta massaggio \varnothing 100 mm (5 posizioni). Flessibile satin.

Sprchová souprava, proti usaz. vod. kamene

Posuvná tyč na nástěnných držácích. Pevná sprcha \varnothing 300 mm.

Materiál mosaz. Ruční masážní sprcha \varnothing 100 mm (5 poloh).

Flexi hadice SATIN. Přizpůsobitelná na celek baterie sprchy a vany-sprchy.

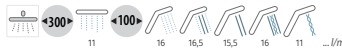
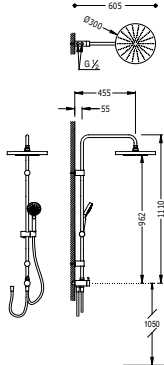

06163507

397,00

Bar-shower set

Sliding wall holder. Fixed shower head 300x300 mm. Brass. Anti-limescale shower. Sateen hose. Adaptable to a bath and shower mixer.

Set doccia

Barra e supporti parete regolabili. Doccia fissa 300x300 mm. Ottone. Doccetta anticalcare. Flessibile satin.

Sprchová souprava, proti usaz. vod. kamene

Posuvná tyč na nástěnných držácích. Pevná sprcha 300x300 mm.

Materiál mosaz. Sprcha, proti usaz. vod. kamene. Flexi hadice SATIN.

Přizpůsobitelná na celek baterie sprchy a vany-sprchy.

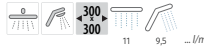
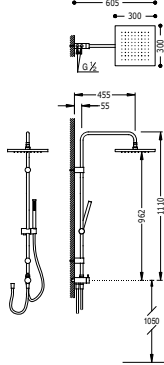

06163508

426,00

Bar-shower set

fixed shower head 250x250 mm. Anti-limescale hand shower. Double interlocked shower hose. Adaptable to a bath and shower mixer.

Set doccia

Doccia fissa 250x250 mm. Doccetta anticalcare. Flessibile doppia graffatura. Ad incasso.

Sprchová souprava, proti usaz. vod. kamene

Pevná sprcha 250x250 mm. Sprcha, proti usaz. vod. kamene. Flexi hadice s dvojitým opletem

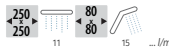
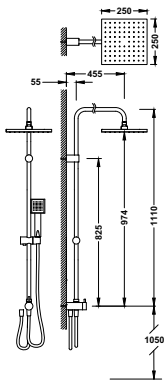

20047501

217,00

Installation Installazione Instalace

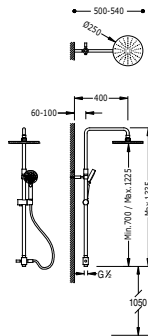
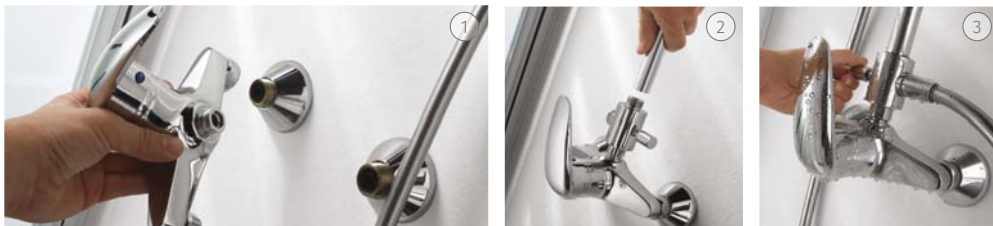

Telescopic shower kit
fixed shower head Ø 250 mm. Massage hand shower Ø 100 mm (5 functions), and sateen hose

Set doccia
Doccia fissa Ø 250 mm. Doccetta Ø 100 mm. (5 funzioni) e manichetta satinata

Sprchová souprava, proti usaz. vod. kamene
Pevná sprcha Ø 250 mm. Flexi hadice SATIN. Ruční masážní sprcha Ø 100 mm (5 funkci). Výsuvná. S roždělovačem

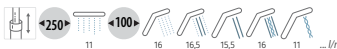

161213

323,00

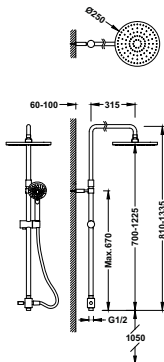

Telescopic shower kit
fixed shower head Ø 250 mm. Anti-limescale hand shower Ø 100 mm. and sateen hose

Set doccia
Doccia fissa Ø 250 mm. Doccetta anticalcare Ø 100 mm. e manichetta satinata

Sprchová souprava, proti usaz. vod. kamene
Pevná sprcha Ø 250 mm. Flexi hadice SATIN. Ruční sprcha, proti usaz. vod. kamene Ø 100 mm. Výsuvná. S roždělovačem

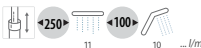

06163509

277,00

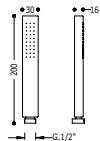

Antilime shower
Doccetta anticalcare
Sprcha, proti usaz. vod. kamene



29963108

17,35

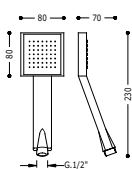

Antilime shower
Doccetta anticalcare
Sprcha, proti usaz. vod. kamene



134612

15,35

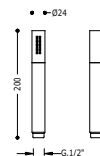

Shower TUB
Ø 24 mm. Brass
Doccia TUB
Ø 24 mm. Ottone
Sprcha TUB
Ø 24 mm. Material Mosaz



913412380

26,50

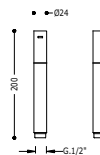

Shower WC
Ø 24 mm. Brass (for Nr.: 34122, 34123, 81122, 81123, 81222, 81223, 62122, 62123, 006123, 205222, 205223, 217123)

Doccia tubo WC
Ø 24 mm. Ottone (per ref.: 34122, 34123, 81122, 81123, 81222, 81223, 62122, 62123, 006123, 205222, 205223, 217123)
Trubková sprška pro WC
Ø 24 mm. Material mosaz. S omezovacím hrdlem 5 l/m. SYSTÉM PROTI KAPÁNÍ (pro ref. ě. 34122, 34123, 81122, 81123, 81222, 81223, 62122, 62123, 006123, 205222, 205223, 217123)



913412390

46,25

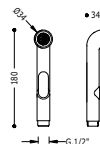

Handshower with locking
(for Nr.: 81113, 62113, 20311301)
Doccetta con chiusura
(per ref.: 81113, 62113, 20311301)
Sprcha s uzávěrem
(pro ref. ě. 81113, 62113, 20311301)



29911351

13,30

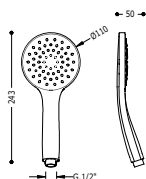

Antilime shower
Doccetta anticalcare
Sprcha, proti usaz. vod. kamene

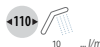

29963105

24,00

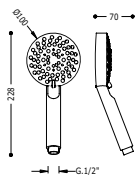

Shower
5 jet types

Doccia
5 tipi di getto
Sprcha
5 typů proudění vody



134748

41,50

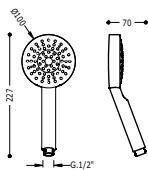

Antilime shower
Doccetta anticalcare

Sprcha, proti usaz. vod. kamene



29974802

25,20

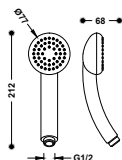

Antilime shower-ANTICAL
Doccetta anticalcare-ANTICAL

Sprcha-ANTICAL



9134725

10,25

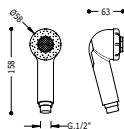

Extractible shower two positions
(for Nr.: 41443, 50443, 7044338, 7344302)

Doccia lavastoviglie
(per ref.: 41443, 50443, 7044338, 7344302)

Sprška na mytí nádob
(pro ref. č. 41443, 50443, 7044338, 7344302)

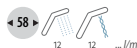

9134880

22,55

Buy your box
Acquista il tuo box
Objednejte si svůj box

SELF-SERVICE BOXES / Shower items, thermostatic sets, mixer taps and shower hoses, ideal for your point of sale.

CASSE SELF-SERVICE / Articoli per doccia, set termostatici, miscelatori monocomando o flessibili, ideali per il punto vendita

SAMOBSLUŽNÉ POKLADNY / Výrobky do sprchy, termostatické sady, jednopákové baterie, kovové hadice, ideální výbava prodejního místa.



www.qtr.es/promo-box



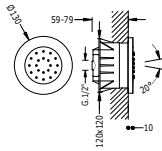

Hydromassage built-in jet

with 1 type of adjustable stream. Includes anti-limescale system, check valve and flow restrictor: 5 L/m. Ø 130 mm.

Bocchetta incassata di idromassaggio

con 1 tipo di getto orientabile. Include un sistema anticalcare, valvola antiritorno e limitatore di flusso: 5 l/m. Ø 130 mm.

Zapuštěná hydromasážní tryska

s 1 typem natáčecího proudu. Má systém proti usazování kamence, zpětný ventil a omezovač průtoku: 5 l/min. Ø 130 mm.



9161515

110,00

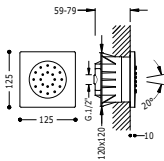

Hydromassage built-in jet

with 1 type of adjustable stream. Includes anti-limescale system, check valve and flow restrictor: 5 L/m. 125x125 mm.

Bocchetta incassata di idromassaggio

con 1 tipo di getto orientabile. Include un sistema anticalcare, valvola antiritorno e limitatore di flusso: 5 l/m. 125x125 mm.

Zapuštěná hydromasážní tryska

s 1 typem natáčecího proudu. Má systém proti usazování kamence, zpětný ventil a omezovač průtoku: 5 l/min. 125x125 mm.



9107515

115,00

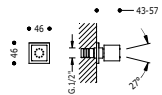

Hydromassage side shower

with 1 type of adjustable stream. Includes anti-limescale system, check valve and flow restrictor: 5 L/m. Brass.

Doccia laterale a idromassaggio

con 1 tipo di getto orientabile. Include un sistema anticalcare, valvola antiritorno e limitatore di flusso: 5 l/m. Materiale Ottone.

Boční hydromasážní sprcha

s 1 typem natáčecího proudu. Má systém proti usazování kamence, zpětný ventil a omezovač průtoku: 5 l/min. Materiál mosaz.



9134515

51,60

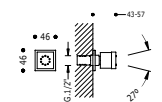

Hydromassage side shower

with 1 type of adjustable stream. Includes anti-limescale system, check valve and flow restrictor: 5 L/m. Brass.

Doccia laterale a idromassaggio

con 1 tipo di getto orientabile. Include un sistema anticalcare, valvola antiritorno e limitatore di flusso: 5 l/m. Materiale Ottone.

Boční hydromasážní sprcha

s 1 typem natáčecího proudu. Má systém proti usazování kamence, zpětný ventil a omezovač průtoku: 5 l/min. Materiál mosaz.



2995101

53,85

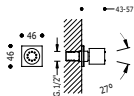

Hydromassage side shower
with 1 type of adjustable stream. Includes anti-limescale system, check valve and flow restrictor: 5 L/m. Brass.

Doccia laterale a idromassaggio
con 1 tipo di getto orientabile. Include un sistema anticalcare, valvola antiritorno e limitatore di flusso: 5 l/m. Materiale Ottone.

Boční hydromasážní sprcha
s 1 typem natáčecího proudu. Má systém proti usazování kamence, zpětný ventil a omezovač průtoku: 5 l/min. Materiál mosaz.



29951503

46,75

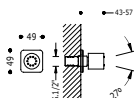

Hydromassage side shower
with 1 type of adjustable stream. Includes anti-limescale system, check valve and flow restrictor: 5 L/m. Brass.

Doccia laterale a idromassaggio
con 1 tipo di getto orientabile. Include un sistema anticalcare, valvola antiritorno e limitatore di flusso: 5 l/m. Materiale Ottone.

Boční hydromasážní sprcha
s 1 typem natáčecího proudu. Má systém proti usazování kamence, zpětný ventil a omezovač průtoku: 5 l/min. Materiál mosaz.



29951502

47,90

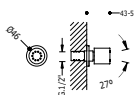

Hydromassage side shower
with 1 type of adjustable stream. Includes anti-limescale system, check valve and flow restrictor: 5 L/m. Brass.

Doccia laterale a idromassaggio
con 1 tipo di getto orientabile. Include un sistema anticalcare, valvola antiritorno e limitatore di flusso: 5 l/m. Materiale Ottone.

Boční hydromasážní sprcha
s 1 typem natáčecího proudu. Má systém proti usazování kamence, zpětný ventil a omezovač průtoku: 5 l/min. Materiál mosaz.



9134415

38,40

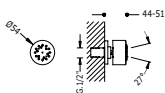

Hydromassage side shower
with 2 types of adjustable stream 6 ltr./m., 4,5 ltr./m.

Doccia laterale a idromassaggio
con 2 tipi di getto orientabile 6 l/m. - 4,5 l/m.

Boční hydromasážní sprcha
ABS, s 2 typem natáčecího proudu. 6 l/m a 4,5 l/m



9134915

30,50

**Hydromassage side shower
with 1 type of adjustable stream 4 ltr./m.**

**Doccia laterale a idromassaggio
con 1 tipo di getto orientabile 4 l/m.**

*Boční hydromasážní sprcha
ABS, s 1 typem natáčecího proudu 4 l/m*

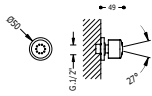

9134615

25,20



Buy your box Acquista il tuo box Objednejte si svůj box

SELF-SERVICE BOXES / Shower items, thermostatic sets, mixer taps and shower hoses, ideal for your point of sale.

CASSE SELF-SERVICE / Articoli per doccia, set termostatici, miscelatori monocomando o flessibili, ideali per il punto vendita

SA MOOB SLUŽNĚ POKLADNY / Výrobky do sprchy, termostatické sady, jednopákové baterie, kovové hadice, ideální výbava prodejního místa.



www.qtrr.es/promo-box

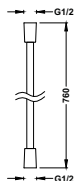

Shower hose SATIN

long. 0,76 m. Ø 14,5 mm. Anti torsion

Flessibile satinato

Longo 0,76 m. Ø 14,5 mm. Girevole antitorsione

Hadice SATIN

délka 0,76 m. Ø 14,5 mm. Otočná, se systémem proti překroucení

913460910

18,75

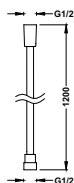

Shower hose SATIN

long. 1,20 m. Ø 14,5 mm. Anti torsion

Flessibile satinato

Longo 1,20 m. Ø 14,5 mm. Girevole antitorsione

Hadice SATIN

délka 1,20 m. Ø 14,5 mm. Otočná, se systémem proti překroucení

913460912

19,60

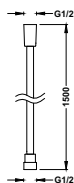

Shower hose SATIN

long. 1,50 m. Ø 14,5 mm. Anti torsion

Flessibile satinato

Longo 1,50 m. Ø 14,5 mm. Girevole antitorsione

Hadice SATIN

délka 1,50 m. Ø 14,5 mm. Otočná, se systémem proti překroucení

913460915

20,15

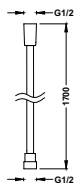

Shower hose SATIN

long. 1,70 m. Ø 14,5 mm. Anti torsion

Flessibile satinato

Longo 1,70 m. Ø 14,5 mm. Girevole antitorsione

Hadice SATIN

délka 1,70 m. Ø 14,5 mm. Otočná, se systémem proti překroucení

9134609

20,80

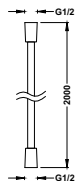

Shower hose SATIN
long. 2,00 m. Ø 14,5 mm. Anti torsion

Flessibile satinato
Longo 2,00 m. Ø 14,5 mm. Girevole antitorsione

Hadice SATIN
délka 2,00 m. Ø 14,5 mm. Otočná, se systémem proti překroučení

913460920

21,20

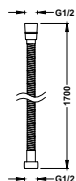

Shower hose INOX EXTENSIBLE
long. 1,70 m. Ø 14 mm.

Flessibile INOX ESTENSIBILE
Longo 1,70 m Ø 14 mm.

Hadice OCEL EXTENSIBILE
délka 1,70 m. Ø 14 mm.

9134630

13,45

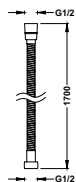

Double interlocked shower hose
long. 1,70 m. Conical nut with ring seal and bolt washer in adapter.
Ten-year warranty

Flessibile doppia graffatura
Longo 1,70 m. Filettatura conica con giunto torico e rosetta integrata nel raccordo. Garanzia 10 anni

Hadice s dvojím zámekem
délka 1,70 m. Kónická matice s těsnícím hroužkem a blokovacím mezikroužkem v přechodce. Záruka deset let

9134828

16,05

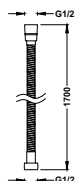

Double interlocked shower hose EXTENSIBLE
long. 1,70 m. Conical nut with ring seal and bolt washer in adapter.
Ten-year warranty

Flessibile doppia graffatura ESTENSIBILE
Longo 1,70 m. Filettatura conica con giunto torico e rosetta integrata nel raccordo. Garanzia 10 anni

Hadice s dvojím zámekem EXTENSIBILE
délka 1,70 m. Kónická matice s těsnícím hroužkem a blokovacím mezikroužkem v přechodce. Záruka deset let

913483080

17,70

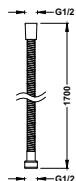

Double interlocked shower hose
long. 1,70 m.

Flessibile doppia graffatura
Longo 1,70 m.

Hadice s dvojím zámekem
délka 1,70 m.

9134830053

75,35

9134830052

75,35

9134830051

75,35

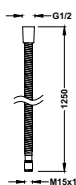

Double interlocked shower hose
long. 1,25 m. Ø 12 mm. (for Nr.: 30444, 41443, 41444, 44444, 50443, 52444, 54444, 70443, 72443, 73443, 73444, 39444, 69444)

Flessibile doppia graffatura
Longo 1,25 m. Ø 12 mm. (per ref.: 30444, 41443, 41444, 44444, 50443, 52444, 54444, 70443, 72443, 73443, 73444, 39444, 69444)

Hadice s dvojím zámekem
délka 1,25 m. Ø 12 mm. (pro ref. € 30.444 41.443, 41.444, 44.444, 50.443, 52.444, 54.444, 70.443, 72.443, 73.443, 73.444)

9134867

29,05

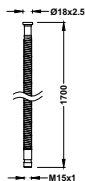
**Hose**

long, 1,70 m. Ø 12 mm. (for Nr.: 30430, 30432, 30433, 14444, 43444, 87444, 130460, 62438, 30452, 81438)

Flessibile

Longo 1,70 m. Ø 12 mm. (per ref.: 30430, 30432, 30433, 14444, 43444, 87444, 130460, 62438, 30452, 81438)

Hadice

délka 1,70 m. Ø 12 mm. pro dřezovou baterii (pro ref. č. 30430, 30432, 30433, 14444, 43444, 87444, 130460, 62438, 30452, 81438)

9134712

25,00

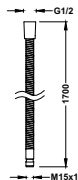
**Double interlocked shower hose****Flessibile doppia graffatura****Hadice s dvojitým zámkem**

long, 1,70 m. per kit bordo vasca / for bath and shower mixer / pro stojánek van. baterii (per ref.: 06161, 07161, 14150, 17145, 39145, 41145, 43145, 43147, 44145, 43147, 44145, 61150, 61161, 61181, 62150, 62161, 63145, 63181, 69145, 72145, 73145, 74145, 85145, 87150, 87161, 87181, 89150, 70145, 81150, 81161, 89161, 200161, 200162, 202161, 202661, 203161, 205161, 261150, 262150)

9134881

28,50

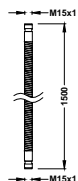
**Shower hose**

long, 1,50 m. (for Nr.: 145 CLASICTRES, MONOCLASIC 1900, RETROTRES)

Flessibile metallico

Longo 1,50 m. (per ref.: 145 CLASICTRES, MONOCLASIC 1900, RETROTRES)

Kovová flexi hadice

délka 1,50 m. (pro ref. č. 145 CLASICTRES, MONOCLASIC 1900, RETROTRES)

9134731

29,15

9134731051

75,35

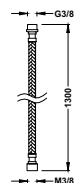
**Shower hose single lever mixer hairdresser's shop**

long, 1,30 m. 3/8" - 3/8" (for Nr.: 72450)

Flesso modello parrucchiera

Longo 1,30 m. 3/8" - 3/8" (per ref.: 72450)

Hadice pro kadeřnickou baterii

délka 1,30 m. 3/8" vnější závit 3/8" vnitřní závit (pro ref. č. 72450)

9134887

14,30

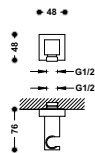

**Shower holder
with wall entrance**

Supporto per doccia
con presa a parete

Úchyt ruční sprchy se stěnovou přípojkou vody
s nástěnným vodním přívodem

00618201

56,25

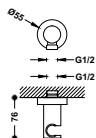

**Shower holder
with wall entrance**

Supporto per doccia
con presa a parete

Úchyt ruční sprchy se stěnovou přípojkou vody
s nástěnným vodním přívodem

20518201

46,25

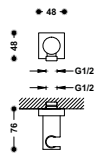

**Shower holder
with wall entrance**

Supporto per doccia
con presa a parete

Úchyt ruční sprchy se stěnovou přípojkou vody
s nástěnným vodním přívodem

06118201

46,25

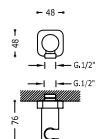

**Shower holder
with wall entrance**

Supporto per doccia
con presa a parete

Úchyt ruční sprchy se stěnovou přípojkou vody
s nástěnným vodním přívodem

20018201

46,25

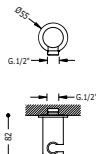

**Shower holder
with wall entrance**

Supporto per doccia
con presa a parete

Úchyt ruční sprchy se stěnovou přípojkou vody
s nástěnným vodním přívodem

02418201

46,25

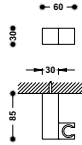

Adjustable holder
Brass

Supporto orientabile
Ottone

Nastavitelný čtvercový držák, kovový
Materiál Mosaz

107839

26,25

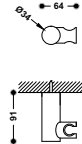

Adjustable holder
Brass

Supporto orientabile
Ottone

Nastavitelný kulatý držák, kovový
Materiál Mosaz

161839

24,90

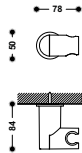

Adjustable holder
Supporto orientabile

Nastavitelný držák

29963901

8,85

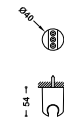

Fixed holder
Supporto fisso

Pevný držák

9134841

6,75

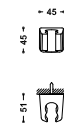

Fixed holder
with two positions for all the hoses

Supporto fisso
con due posizioni. Per tutti i flessi

Pevný držák
s 2 polohami pro všechny flexi hadice

9134848

6,75

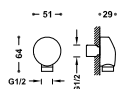

**Wall elbow adapter for shower hose
water supply connection 1/2"**

**Angolo presa parete flessibile
presa acqua 1/2"**

*Kolínko nástěnným přívodem pro flexi hadici
přívod vody 1/2"*

134757

20,85

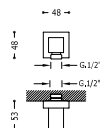

**Wall elbow adapter for shower hose
water supply connection 1/2"**

**Angolo presa parete flessibile
presa acqua 1/2"**

*Kolínko nástěnným přívodem pro flexi hadici
přívod vody 1/2"*

00618301

54,35

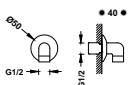

**Wall elbow adapter for shower hose
water supply connection 1/2"**

**Angolo presa parete flessibile
presa acqua 1/2"**

*Kolínko nástěnným přívodem pro flexi hadici
přívod vody 1/2"*

134873

18,60

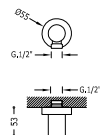

**Wall elbow adapter for shower hose
water supply connection 1/2"**

**Angolo presa parete flessibile
presa acqua 1/2"**

*Kolínko nástěnným přívodem pro flexi hadici
přívod vody 1/2"*

20518301

29,95

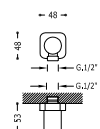

**Wall elbow adapter for shower hose
water supply connection 1/2"**

**Angolo presa parete flessibile
presa acqua 1/2"**

*Kolínko nástěnným přívodem pro flexi hadici
přívod vody 1/2"*

20018301

29,95

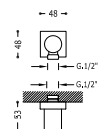

**Wall elbow adapter for shower hose
water supply connection 1/2"**

**Angolo presa parete flessibile
presa acqua 1/2"**

*Kolínko nástěnným přívodem pro flexi hadici
přívod vody 1/2"*

06118301

29,95



OTHER | PORTASAPONE | OSTATNÍ



Soap dish LEX
for sliding bar \varnothing 20,5 mm. (for Nr.: 181821, 181921)

Portasapone LEX
per asta antiscivolo \varnothing 20,5 mm. (per ref.: 181821, 181921)

Mýdlenka LEX
na posuvnou tyč \varnothing 20,5 mm. (pro ref. č. 181821, 181921)

918192105

20,25



Soap dish CUB
for sliding bar \varnothing 18 mm. - \varnothing 24 mm.

Portasapone CUB
per asta antiscivolo \varnothing 18 mm. - \varnothing 24 mm.

Mýdlenka CUB
pro tyč \varnothing 18 mm a \varnothing 24 mm

918719510

27,85



Soap dish DOBLE
for sliding bar \varnothing 18 mm. - \varnothing 24 mm.

Portasapone DOUBLE
per asta antiscivolo \varnothing 18 mm. - \varnothing 24 mm.

Mýdlenka DOBLE
pro tyč \varnothing 18 mm a \varnothing 24 mm

916119510

22,60



581 / **Valve** | Valvola | Ventil588 / **Bath drain** | Scarico vasca | Vanový sifon589 / **Siphon** | Sifone | Sifon591 / **Spout** | Erogatore Vasca | Výtoková hubice591 / **Cover plate** | Rosone | Krycí rozeta593 / **Adjustment key** | Chiave di regolazione /
Uzavírací ventil594 / **Elbow adaptor** | Gomito adattatore | Rohový ventil596 / **Outlet valve** | Valvola di svuotamento / Vypouštěcí ventil597 / **Flow restrictors** | Limitatori di flusso /
Omezovače průtoku598 / **Aerator** | Ariatore | Perlátor

TRÉS

**COMPLEMENTS
COMPLEMENTI
PŘÍSLUŠENSTVÍ**



www.qrtr.es/complements



Chrome
Cromato
Chrom



Simple-Rapid valve Valvola Simple-Rapid Ventil Simple-Rapid

UPPER LOCKING SYSTEM
BLOCCAGGIO SUPERIORE
HORNÍ BLOKÁDA

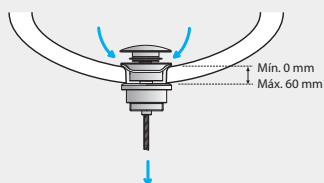

Counter top without overflow drain
Piano senza troppopieno
Deska bez přepadu

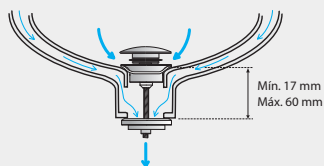

Counter top with overflow drain
Piano con troppopieno
Deska s přepadem

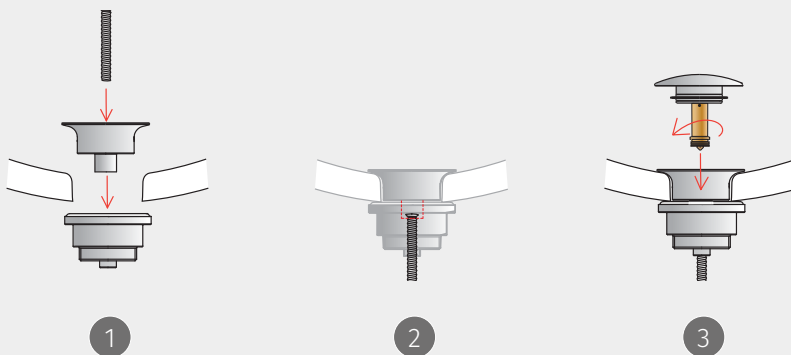

Valve for basin Valvola lavabo Ventil pro umyvadlo

INFERIOR LOCKING SYSTEM
BLOCCAGGIO INFERIORE
SPODNÍ BLOKÁDA

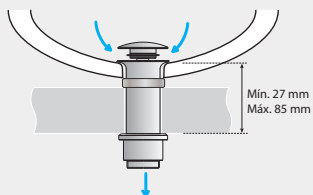

Wood counter top...
Piano in legno...
Dřevěná deska a jiné...

13494010 / 13494110 / 13494210

VENTIL SIMPLE-RAPID | VALVOLA SIMPLE-RAPID | SIMPLE-RAPID VALVE

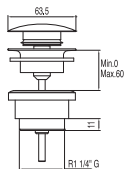

SIMPLE-RAPID valve
Ø 63,5 mm CLICK-CLACK
 Valvola SIMPLE-RAPID
 Ø 63,5 mm CLICK-CLACK
 Ventil SIMPLE-RAPID
 zátka Ø 63,5 mm CLICK-CLACK

■ 161840

37,95

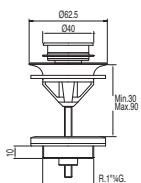

SIMPLE-RAPID valve
CLICK-CLACK
 Valvola SIMPLE-RAPID
 CLICK-CLACK
 Ventil SIMPLE-RAPID
 CLICK-CLACK

■ 162840

30,15

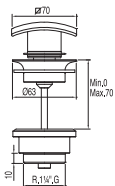

SIMPLE-RAPID valve CUADRO-TRES
70x70 mm CLICK-CLACK
 Valvola SIMPLE-RAPID CUADRO-TRES
 70x70 mm CLICK-CLACK
 Ventil SIMPLE-RAPID pro řadu CUADRO-TRES
 Čtverhranná zátka 70x70 mm CLICK-CLACK

■ 107940

66,15

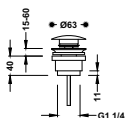

SIMPLE-RAPID valve
Ø 63 mm CLICK-CLACK
 Valvola SIMPLE-RAPID
 Ø 63 mm CLICK-CLACK
 Umyvadlový ventil SIMPLE-RAPID
 zátka Ø 63 mm CLICK-CLACK

■ 13454010

22,70

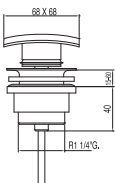

SIMPLE-RAPID valve
68x68 mm CLICK-CLACK
 Valvola SIMPLE-RAPID
 68x68 mm CLICK-CLACK
 Umyvadlový ventil SIMPLE-RAPID
 Čtvercová zátka 68x68 mm CLICK-CLACK

■ 13434010

26,20



VALVE FOR BASIN WITHOUT OVERFLOW DRAIN | VALVOLA LAVABO SENZA TROPPOPIENO | VENTIL PRO UMYVADLO BEZ PŘEPADU

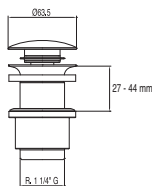

Valve for basin
Ø 63,5 mm CLICK-CLACK (27-44 mm.)

Valvola lavabo
Ø 63,5 mm CLICK-CLACK (27-44 mm.)

Zaslepený ventil pro dřevěné umyvadlo
zátko Ø 63,5 mm CLICK-CLACK (27-44 mm.)

13494010

53,45

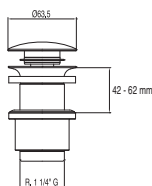

Valve for basin
Ø 63,5 mm CLICK-CLACK (42-62 mm.)

Valvola lavabo
Ø 63,5 mm CLICK-CLACK (42-62 mm.)

Zaslepený ventil pro dřevěné umyvadlo
zátko Ø 63,5 mm CLICK-CLACK (42-62 mm.)

13494110

55,30

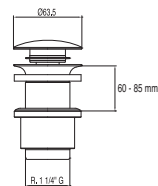

Valve for basin
Ø 63,5 mm CLICK-CLACK (60-85 mm.)

Valvola lavabo
Ø 63,5 mm CLICK-CLACK (60-85 mm.)

Zaslepený ventil pro dřevěné umyvadlo
zátko Ø 63,5 mm CLICK-CLACK (60-85 mm.)

13494210

58,75

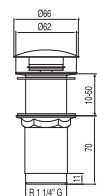

Valve for basin without overflow drain
Ø 66 mm CLICK-CLACK

Valvola lavabo senza troppopieno
Ø 66 mm CLICK-CLACK

Umyvadlový ventil bez přepadu
zátko Ø 66 mm CLICK-CLACK

13454060

21,40

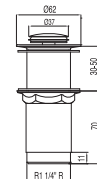

Valve for basin without overflow drain
Ø 37 mm CLICK-CLACK

Valvola lavabo senza troppopieno
Ø 37 mm CLICK-CLACK

Umyvadlový ventil bez přepadu
zátko Ø 37 mm CLICK-CLACK

13454050

18,70

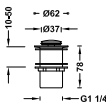

Valve for basin without overflow drain
Ø 37 mm CLICK-CLACK

Valvola lavabo senza troppopieno
Ø 37 mm CLICK-CLACK

Umyvadlový ventil bez přepadu
zátko Ø 37 mm CLICK-CLACK

13454070

15,90

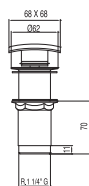

**Valve for basin without overflow drain
68x68 mm CLICK-CLACK**

Valvola lavabo senza troppopieno
68x68 mm CLICK-CLACK

Umyvadlový ventil bez přepadu
Čtvercová zátká 68x68 mm CLICK-CLACK

13434120

26,20

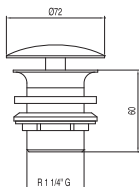

**Free basin valve (drain always open)
Ø 72 mm**

Valvola lavabo a scarico libero (scarico sempre aperto)
Ø 72 mm

Umyvadlový ventil s volným (vždy otevřeným) odtokem
zátká Ø 72 mm

13424010

19,70

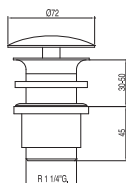

**Free basin valve (drain always open)
Ø 72 mm**

Valvola lavabo a scarico libero (scarico sempre aperto)
Ø 72 mm

Umyvadlový ventil s volným (vždy otevřeným) odtokem
zátká Ø 72 mm

13424020

24,95

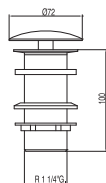

**Free basin valve (drain always open)
Ø 72 mm**

Valvola lavabo a scarico libero (scarico sempre aperto)
Ø 72 mm

Umyvadlový ventil s volným (vždy otevřeným) odtokem
zátká Ø 72 mm

13424030

21,05

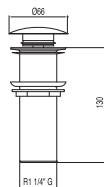

**Valve for basin without overflow drain
Ø 66 mm CLICK-CLACK**

Valvola lavabo senza troppopieno
Ø 66 mm CLICK-CLACK

Umyvadlový ventil bez přepadu
zátká Ø 66 mm CLICK-CLACK

13454030

32,80



VALVE FOR BASIN WITH OVERFLOW DRAIN | VALVOLA LAVABO CON TROPPOPIENO | VENTIL PRO UMYVADLO S PŘEPADEM

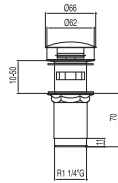

Valve for basin with overflow drain
Ø 66 mm CLICK-CLACK

Valvola lavabo con troppopieno
 Ø 66 mm CLICK-CLACK

Umyvadlový ventil s přepadem
 zátka Ø 66 mm CLICK-CLACK

13454160

21,40

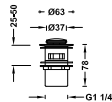

Valve for basin with overflow drain
Ø 37 mm CLICK-CLACK

Valvola lavabo con troppopieno
 Ø 37 mm CLICK-CLACK

Umyvadlový ventil s přepadem
 zátka Ø 37 mm CLICK-CLACK

13454110

18,70

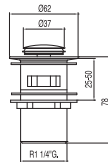

Valve for basin with overflow drain
Ø 37 mm CLICK-CLACK

Valvola lavabo con troppopieno
 Ø 37 mm CLICK-CLACK

Umyvadlový ventil s přepadem
 zátka Ø 37 mm CLICK-CLACK

13454190

15,90

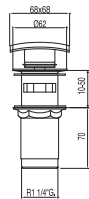

Valve for basin with overflow drain
68x68 mm CLICK-CLACK

Valvola lavabo con troppopieno
 68x68 mm CLICK-CLACK

Umyvadlový ventil s přepadem
 čtvercová zátka 68x68 mm CLICK-CLACK

13434020

26,20

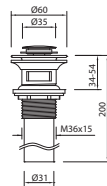

Valve for basin with overflow drain
Ø 35 mm CLICK-CLACK

Valvola lavabo con troppopieno
 Ø 35 mm CLICK-CLACK

Umyvadlový ventil s přepadem
 zátka Ø 35 mm CLICK-CLACK

03454002

22,60

BATH DRAIN | SCARICO VASCA | VANOVÝ SIFON

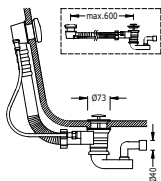

Bath drain with overflow and pop-up waste
 Ø 73 mm

 Scarico vasca con troppo pieno e valvola automatica
 Ø 73 mm

Automatický odtok vany s přepadem
zátky Ø 73 mm

134846

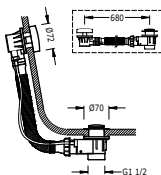
95,15



Bath drain with overflow and pop-up waste
 Ø 43 mm

 Scarico vasca con troppo pieno e valvola automatica
 Ø 43 mm

Automatický odtok vany s přepadem
zátky Ø 43 mm

13453410

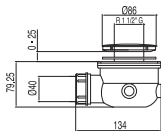
30,15



Siphon drain for inspection
 Ø 86 mm. Drain 15 l/min

 Scarico ispezionabile
 Ø 86 mm. Scolo 15 l/min.

Rozšroubovatelný sifonový odtok pro sprchovou vaničku,
se zabudovaným sifonem
odtok 15 l/min, Ø 86 mm

134552

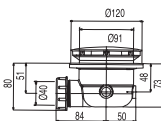
28,10



Siphon drain for inspection
 Ø 120 mm. Drain 31 l/min

 Scarico ispezionabile
 Ø 120 mm. Scolo 31 l/min.

Rozšroubovatelný sifonový odtok pro sprchovou vaničku,
se zabudovaným sifonem
odtok 31 l/min, Ø 120 mm

104840

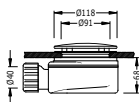
41,45



Siphon drain for inspection
 Ø 118 mm. Drain 62 l/min

 Scarico ispezionabile
 Ø 118 mm. Scolo 62 l/min.

Rozšroubovatelný sifonový odtok pro sprchovou vaničku,
se zabudovaným sifonem
odtok 62 l/min, Ø 118 mm

104841

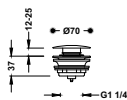
41,45



Valve
 Ø 70 mm CLICK-CLACK

 Valvola
 Ø 70 mm CLICK-CLACK

Vanový ventil
zátky Ø 70 mm CLICK-CLACK

13474010

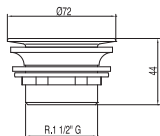
18,10



Valve
Ø 72 mm

Valvola
Ø 72 mm

Odtok pro prádelnové umyvadlo nebo podobně
Ø 72 mm

13474020

7,80

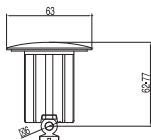

Plug with trim supplement for automatic drain
Ø 63 mm 1,1/4"

Tappo con supplemento estetico per scarico automatico
Ø 63 1,1/4"

Zátka se zkrášlujícím doplňkem pro automatický odtok
Ø 63 mm standardní automatický odtok

913484026

10,45

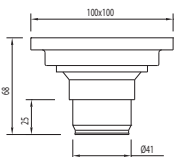

Drain trap
Brass

Scarico
Ottone

Odtokový kanálek
Mosaz

03474007

19,95

SIPHON | SIFONE | SIFON

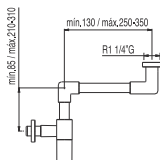

Telescopic visible basin drain trap

Sifone telescopico a vista per lavabo

Umyvadlový viditelný sifon, ohnutý, výsuvný

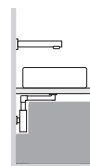

16110362

156,00

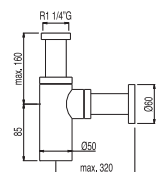

Telescopic visible basin drain trap

Sifone telescopico a vista per lavabo

Výsuvný umyvadlový viditelný sifon

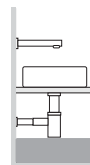

16110372

72,80

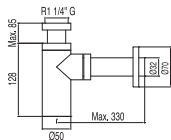

Telescopic visible basin drain trap
Sifone telescopico a vista per lavabo
Výsuvný umyvadlový viditelný sifon

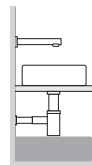

13463410 36,95

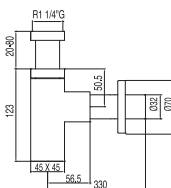

Telescopic visible basin drain trap
Sifone telescopico a vista per lavabo
Čtverhranný, výsuvný umyvadlový sifon viditelný

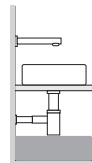

13463420 53,90

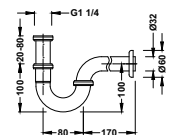

Curved, articulated drain trap for basin
Sifone curvo articolato per lavabo
Umyvadlový sifon s kloubovým zakřivením

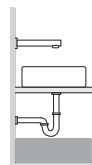

13463810 19,70

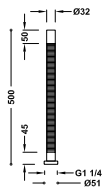

Flexible corrugated drain pipe
Brass long. 500 mm.

Tubo corrugato scarico
Ottone lungo 500 mm.

Pružná vlnitá trubka pro odtok
Mosaz, délka 500 mm

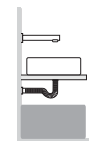

913463250 15,85

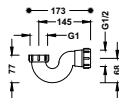

Bath PVC drain trap
Sifone PVC vasca
Vanový sifon z PVC

13463460 4,10

COVER PLATE | ROSONE | KRYCÍ ROZETA

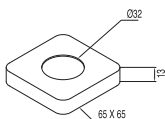

Cover plate
65x65, Ø32, 13 mm

Rosone
65x65, Ø32, 13 mm

Čtvercová kovová rozeta
vnější rozměry 65x65, vnitřní rozměry Ø 32, výška 13 mm

913474410

5,05

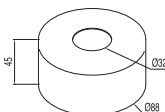

Cover plate
Ø 88, Ø 32, 45 mm

Rosone
Ø 88, Ø 32, 45 mm

Kulatá kovová rozeta
vnější rozměry Ø 88, vnitřní rozměry Ø 32, výška 45 mm

913474430

7,50



Cover plate
Ø 80, Ø 32, 14 mm

Rosone
Ø 80, Ø 32, 14 mm

Kulatá kovová rozeta
vnější rozměry Ø 80, vnitřní rozměry Ø 32, výška 14 mm

913474420

5,05

SPOUT | EROGATORE VASCA | VÝTOKOVÁ HUBICE

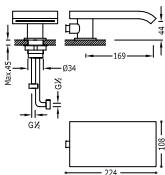

Cascade cast spout

Erogatore a cascata
Ramínko s vodopádem

16216150

376,00

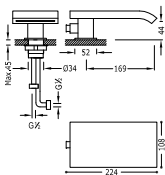

Cascade cast spout

Erogatore a cascata
Ramínko s vodopádem

18718250

398,00

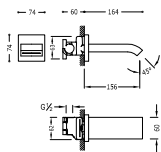

**Cascade cast spout****Erogatore a cascata***Ramínko s vodopádem*

107181

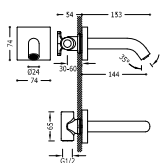
241,00**Wall spout****Canna parete***Nástěnné ramínko*

21018107

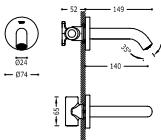
97,85**Wall spout****Canna parete***Nástěnné ramínko*

26218004

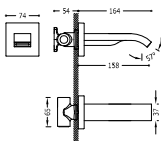
97,85**Cascade cast spout****Erogatore a cascata***Ramínko s vodopádem*

20718107

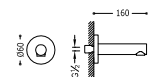
241,00**Wall spout****160 mm. It is not a spare part. It is not compatible with indivisible inbuilt units.****Canna parete****160 mm. Non è un ricambio. Non è compatibile con elementi incorporati indivisibili.***Nástěnné ramínko**160 mm. Nejedná se o náhradní díl. Nelze kombinovat s nedělitelnými podomítkovými tělesy.*

16117002

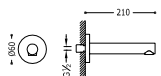
88,75**Wall spout****210 mm. It is not a spare part. It is not compatible with indivisible inbuilt units.****Canna parete****210 mm. Non è un ricambio. Non è compatibile con elementi incorporati indivisibili.***Nástěnné ramínko**210 mm. Nejedná se o náhradní díl. Nelze kombinovat s nedělitelnými podomítkovými tělesy.*

06117202

101,00

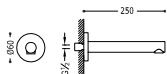

Wall spout

250 mm. It is not a spare part. It is not compatible with indivisible inbuilt units.

Canna parete

250 mm. Non è un ricambio. Non è compatibile con elementi incorporati indivisibili.

Nástěnné ramínko

250 mm. Nejedná se o náhradní díl. Nelze kombinovat s nedělitelnými podomítkovými tělesy.

16117102

112,00

SHUTOFF VALVES | RUBINETTI DI ARRESTO | PRŮCHOŽÍ VENTILY

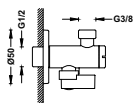

Gate-valve with filter

R.1/2" - R.3/8"

Chiave di regolazione con filtro

R.1/2" - R.3/8"

Uzavírací ventil s filtrem

R.1/2" - R.3/8"

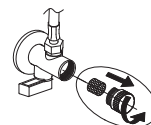

9134525

14,65

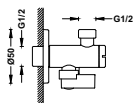

Gate-valve with filter

R.1/2" - R.1/2"

Chiave di regolazione con filtro

R.1/2" - R.1/2"

Uzavírací ventil s filtrem

R.1/2" - R.1/2"

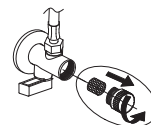

29952505

14,65

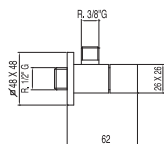

Adjustment key

Chiave di regolazione

Čtverhranný regulační ventil

13474220

13,65

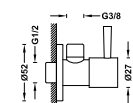

Adjustment key

Chiave di regolazione

Regulační ventil

13474210

11,20



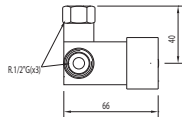

**Two-water mixer WITH FLEXIBLE PIPES
(TRESTRONIC, TOUCH-TRES, TEMPO-TRES)**

Miscelatore due acque CON TUBI FLESSIBILI
(TRESTRONIC, TOUCH-TRES, TEMPO-TRES)

Směšovač na dvě vody S FLEXIBILNÍMI TRUBKAMI
pro umývadlové baterie TRESTRONIC, TOUCH-TRES a TEMPO-TRES

19250730

62,75

OTHER | ALTRI | OSTATNÍ

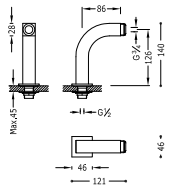

**Shower-bath elbow adaptor
2 units with silencer**

Gomito adattatore bagno-doccia
2 unità con silenziatore

Rohový ventil vana-sprcha
2 kusy s tlumičem

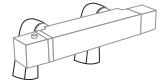

29987002

110,00

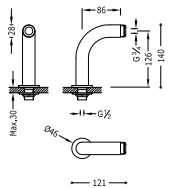

**Shower-bath elbow adaptor
2 units with silencer**

Gomito adattatore bagno-doccia
2 unità con silenziatore

Rohový ventil vana-sprcha
2 kusy s tlumičem

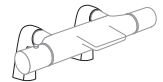

29987001

97,70

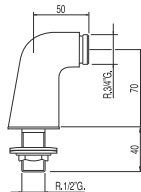

**Shower-bath elbow adaptor
2 units with silencer**

Gomito adattatore bagno-doccia
2 unità con silenziatore

Rohový ventil vana-sprcha
2 kusy s tlumičem

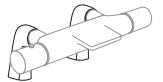

134-870

76,90

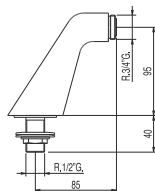

**Shower-bath elbow adaptor
2 units with silencer**

Gomito adattatore bagno-doccia
2 unità con silenziatore

Rohový ventil vana-sprcha
2 kusy s tlumičem

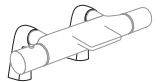

134-871

88,75

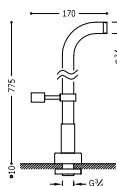

Water intake at floor of bath
2 units with adjustable shower support

Prese d'acqua a terra per vasca da bagno
2 unità con supporto doccia girevole

Vodovodní přípojky na okraj vany
2 kusy s otočným sprchovým držákem

161194

267,00

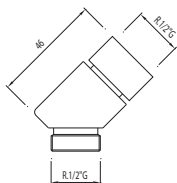

Elbow for hand shower to place on bathtub edge
(for Nr.: 14.150, 61.150, 62.150, 63.145, 61.161, 87.150, 87.161, 89.150, 89.161)

U per doccia
per kit bordo vasca (per ref.: 14.150, 61.150, 62.150, 63.145, 61.161, 87.150, 87.161, 89.150, 89.161)

Kolínko pro sprchu, pro stojánkovou vanovou baterii
(pro ref. č. 14.150, 61.150, 62.150, 63.145, 61.161, 87.150, 87.161, 89.150, 89.161)

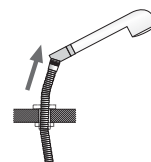

913414580

38,25

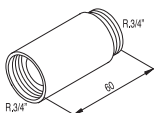

Bath and shower extension adapter
2 unidades con silenciador

Prolunga adattatore bagno-doccia
2 unidades con silenciador

Nástěnný nástavec - přídatný díl pro vanu-sprchu
2 unidades con silenciador

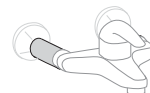

9134872

30,80

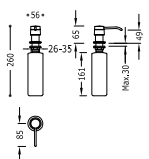

Metal soap dispenser
To be fitted in countertops. Capacity 0.4 litres

Dispenser metallico per sapone
Da incassare su top. Capienza 0,4 litri

Kovová nádobka na mýdlo
pro poličky či okraje vany. Objem 0,4 l

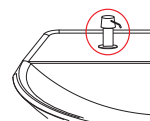

13474110

20,25

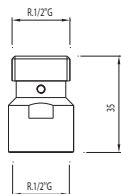

OUTLET VALVE | VALVOLA DI SVUOTAMENTO | VYPOUŠTĚČÍ VENTIL

**Outlet valve****Valvola di svuotamento***Vypouštěčcí ventil*

Funziona con le docce / For use with showers / Vhodné pro sprchy: 134126, 9134729, 913472906, 9134725, 134821, 134617, 134616, 134924, 9134824, 913482510, 134611. Funziona con i soffioni / For use with spray nozzles / Vhodné pro kropička: 13413825, 13413826, 13413830, 19312310, 13413725, 13413726, 13413730.

913478906

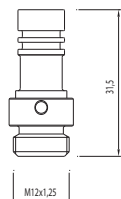
14,90**Outlet valve****(for Nr.: 07395, 07926, 07131)****Valvola di svuotamento****(per ref.: 07395, 07926, 07131)***Vypouštěčcí ventil**(Kód.: 07395, 07926, 07131)*

913478907

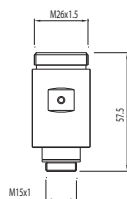
12,65**Outlet valve****since 2012 (for Nr.: 81385, 81191)****Valvola di svuotamento****Dal 2012 (per ref.: 81385, 81191)***Vypouštěčcí ventil**od 2012 (Kód.: 81385, 81191)*

913478908

14,90

Anti-legionella and no-drip water inlet restrictor *Limitatore antilegionella e antigoccia* *Omezovač-vyprazdňovač proti bakterii legionella a proti kapání*



- Limits the flow of water, meaning there is no pressure in the shower head.
- Avoids the growth of bacteria such as legionella.
- Prevents dripping from the shower head when the shower is no longer in use.

- Limita il flusso d'acqua eliminando la pressione nel soffione.
- Evita la procreazione di batteri come la legionella.
- Una volta terminato l'uso della doccia, evita il gocciolamento del soffione.

- Omezuje průtok vody a uvolňuje tlak v kropičku.
- Zabráňuje rozmnožování bakterii jako legionella.
- Když se sprcha nepoužívá, zabráňuje kapání kropička.

For use with showers / Funziona con le docce / Vhodné pro sprchy: 1.34.126, 91.34.729, 91.34.729.06, 91.34.725, 1.34.821, 1.34.617, 1.34.616, 1.34.924, 91.34.824, 91.34.825.10, 1.34.611.
For use with spray nozzles* / Funziona con i soffioni* / Vhodné pro kropička*: 1.34.138.25, 1.34.138.26, 1.34.138.30, 1.93.123.10, 1.34.137.25, 1.34.137.26, 1.34.137.30.

**Works better if the restrictor is removed from the spray nozzles / *Miglior funzionamento se si elimina il limitatore dai soffioni / *Pokud omezovač kropiček sejmete, funguje lépe.*



Flow reducer
Male 24/100. 6 l/m.
 Limitatore di portata
 maschio 24/100. 6 l/m.
 Omezovač průtoku
 vnější závit 24/100. 6 l/m.

91346826

2,70



Flow reducer
Male 24/100. 8 l/m. Certificate.
 Limitatore di portata
 Maschio 24/100. 8 l/m. Certificato.
 Omezovač průtoku
 vnější závit 24/100. 8 l/m. Osvědčení.

9134682

9,30



Flow reducer
Male 24/100. 5 l/m. Certificate.
 Limitatore di portata
 Maschio 24/100. 5 l/m. Certificato.
 Omezovač průtoku
 vnější závit 24/100. 5 l/m. Osvědčení.

91346825

9,30



Flow reducer
female 22/100. 6 l/m.
 Limitatore di portata
 femmina 22/100. 6 l/m.
 Omezovač průtoku
 vnitřní závit 22/100. 6 l/m.

91346816

2,50



Flow reducer
female 22/100. 8 l/m. Certificate.
 Limitatore di portata
 femmina 22/100. 8 l/m. Certificato.
 Omezovač průtoku
 vnitřní závit 22/100. 8 l/m. Osvědčení.

9134681

9,30



Flow reducer
female 22/100. 5 l/m. Certificate.
 Limitatore di portata
 femmina 22/100. 5 l/m. Certificato.
 Omezovač průtoku
 vnitřní závit 22/100. 5 l/m. Osvědčení.

91346815

9,30



**Flow reducer**

1/2" - 1/2" male - female. 8 l/m. Certificate.

Limitatore di portata

1/2" - 1/2" maschio - femmina. 8 l/m. Certificato.

Omezovač průtoku

1/2" - 1/2" Vnější-vnitřní závit. 8 l/m. Osvědčení.

9134683

5,80

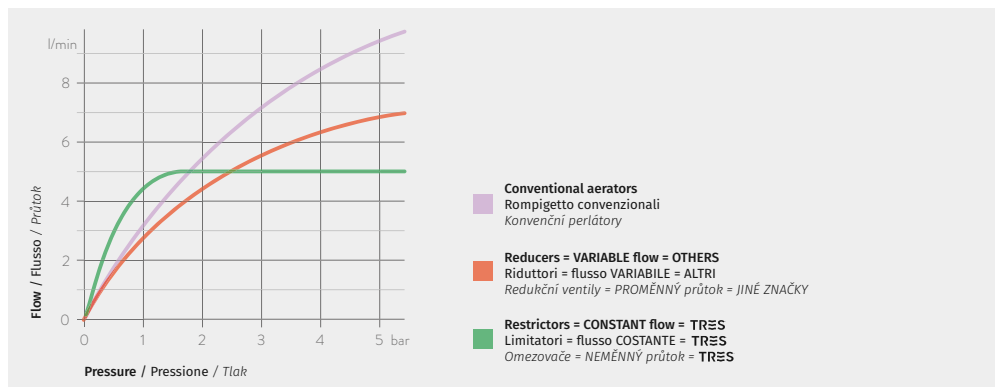

AERATOR | ARIATORE | PERLÁTOR

**Aerator SLC**

24/100 for wash-basin, bidet and sink mixers.

Ariatore maschio SLC

24/100 per lavabo, bidè e lavello.

Perlátor s vnějším závitem Cascade SLC

Pro umyvadlovou, bidetovou a dřezovou baterii (pro celky vana-sprcha a ref. č. 14.100, 14.160, 62.100, 63.151) 24/100

9134673

5,15

9134673503

10,00

9134673501

10,00

**Aerator SLC**

22/100

Ariatore femmina SLC

22/100

Perlátor s vnějším závitem Cascade SLC

(pro ref. č. 23.120, 23.525, 70.120, 72.120, 73.120, 34.880) 22/100

9134672

4,95

9134672501

10,00



Aerator
24/100 for bath and shower
 Ariatore maschio
 24/100 per bagno e doccia
 Perlátor s vnějším závitem
 24/100 vanových, sprchových,

29966310

5,15



Aerator
male 24/100
 Ariatore
 maschio 24/100
 Perlátor
 vnější 24/100

29961001

3,90



Aerator
male 16/100
 Ariatore
 maschio 16/100
 Perlátor
 vnější 26/100

29961002

5,05



Aerator
male 16/100
 Ariatore
 maschio 16/100
 Perlátor
 vnější 26/100

29961005

4,35



Swivel aerator + key
male 24/100
 Rompigitto orientabile + chiave
 maschio 24/100
 Nastavitelný sytič vzduchem + klíč
 vnější 24/100

29961006

5,25



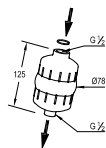

ANTI-CHLORINE filter
Filtering water up to 10.000 litres.

Filtro ANTICLORO
Acqua filtrata fino a 10.000 litri.

Filtr NA CHLOR pro SPRCHU
Až 10 tisíc litrů filtrované vody.

13035590

65,75

Filtered chlorine-free water also in the shower Chlorine Acqua filtrata senza cloro anche nella doccia Filtrovaná voda bez chlóru i ve sprše

A toxic substance, is absorbed by the skin when showering. Our filter reduces the amount of impurities, sediment, odour and chlorine by up to 99%. Ideal for those allergic to chlorine.

Durante la doccia il cloro, che è tossico, viene assorbito dalla pelle. Il nostro filtro riduce sino ad un 99% la quantità d'impurità, sedimenti, odore e cloro. Ideale per persone allergiche al cloro.

Chlór se při sprchování vstřebává do kůže a je toxický. Tento filtr redukuje množství nečistot, usazenin, zápach a chlór až z 99 %. Vhodné pro osoby alergické na chlor.

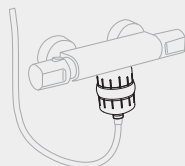

Acqua filtrata fino a 10.000 litri.
Filtering water up to 10.000 litres.
Účinná filtrace až do 10.000 litrů vody.

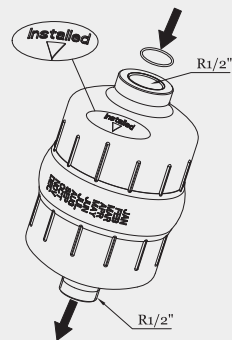



LIST OF PRODUCT REFERENCES
LISTA DI CODICI ARTICOLI
SEZNAM REFERENCÍ

LIST OF PRODUCT REFERENCES / LISTA DI CODICI ARTICOLI / SEZNAM REFERENC

Ref./Nr./Kód	Price	Page	Ref./Nr./Kód	Price	Page	Ref./Nr./Kód	Price	Page	Ref./Nr./Kód	Price	Page	Ref./Nr./Kód	Price	Page
00														
			00620101BL	238,00	59	006486OM	641,00	170	00719102	625,00	384	02463613AC	179,00	161
00610101	144,00	419	00620101BE	238,00	59	00648701	372,00	176	00719102	625,00	429	02463613LM	151,00	161
00610101AC	238,00	58	00620101NE	238,00	59	00648701AC	614,00	176	00719501	869,00	339	02463613OR	216,00	161
00610101BL	238,00	58	00620101NM	238,00	59	00648701AM	614,00	176	00719701	557,00	385	02463615AC	166,00	160
00610101BM	238,00	58	00620101OM	288,00	59	00648701BM	614,00	176	00719702	557,00	384	02463615LM	140,00	160
00610101D	163,00	419	00620101OR	288,00	59	00648701BU	614,00	176	00719702	557,00	430	02463615OR	200,00	160
00610101NE	238,00	58	00620501AC	376,00	60	00648701FU	614,00	176	00731201	869,00	346	03		
00610101NM	238,00	58	00620501BE	376,00	60	00648701INA	614,00	176	00738501	556,00	343	030335AC	323,00	179
00610101OM	288,00	58	00620501NM	376,00	60	00648701NE	614,00	176	00738502	608,00	349	030335BM	323,00	179
00610101OR	288,00	58	00620501OM	455,00	60	00648701NO	614,00	176	00739502AC	1.314,00	69	030335NM	323,00	179
00610102	144,00	418	00620501OR	455,00	60	00648701NM	614,00	176	00739502AC	1.314,00	339	030335OM	391,00	179
00610102D	163,00	418	00628003	562,00	391	00648701VE	614,00	176	00739502BM	1.314,00	69	030336AC	303,00	173
00610503	201,00	424	00628003	562,00	433	00660502AC	365,00	60	00739502NM	1.314,00	69	030336BM	303,00	173
00610503AC	332,00	61	00628003AC	928,00	66	00660502BM	365,00	60	00739502NM	1.314,00	339	030336OM	301,00	535
00610503BM	332,00	61	00628003BM	928,00	66	00660502NM	365,00	60	00739504	742,00	339	03045501	216,00	535
00610503NM	332,00	61	00628003OM	1.125,00	66	00660502OM	441,00	60	00749501	613,00	349	03048701	333,00	176
00610503OM	402,00	61	00628003OR	1.125,00	66	00660502OR	441,00	60	00750301AC	230,00	62	030496BM	384,00	170
00610503OR	402,00	61	00628004	589,00	390	00660602AC	381,00	60	00750301BM	230,00	62	030496NM	384,00	170
00610504	206,00	424	00628004	589,00	432	00660602BM	381,00	60	00750301NM	230,00	62	030496OM	466,00	170
00610504AC	340,00	61	00628004AC	579,00	432	00660602NM	381,00	60	00750301OM	278,00	62	030497BM	413,00	171
00610504BM	340,00	61	00628004BM	972,00	66	00660602OM	461,00	60	00750301OR	278,00	62	030497NM	413,00	171
00610504NM	340,00	61	00628004NM	972,00	66	00660602OR	461,00	60	00810501	223,00	425	030497OM	501,00	171
00610504OM	412,00	61	00628004OM	1.178,00	66	00660702AC	405,00	61	00810501AC	368,00	62	030498BM	407,00	170
00610504OR	412,00	61	00628004OR	1.178,00	66	00660702BM	405,00	61	00810501BM	368,00	62	030498NM	407,00	170
00611001	238,00	420	00628005	876,00	392	00660702NM	405,00	61	00810501NM	368,00	62	030498OM	492,00	170
00611001BL	394,00	59	00628005	876,00	434	00660702OM	490,00	61	00810501OM	445,00	62	03411601	31,75	326
00611001D	254,00	420	00628005AC	1.445,00	66	00660702OR	490,00	61	00810501OR	445,00	62	03411601AC	52,40	326
00611001NE	394,00	59	00628005BM	1.445,00	66	00661001	278,00	419	00810502	201,00	425	03411601AM	52,40	326
00611001OR	238,00	420	00628005NM	1.445,00	66	00661001AC	459,00	58	00810503	232,00	424	03411601BL	52,40	326
00611002BL	394,00	59	00628005OM	1.751,00	66	00661001BL	459,00	58	00810503AC	232,00	62	03411601BM	52,40	326
00611002D	254,00	420	00628005OR	1.751,00	66	00661001BM	459,00	58	00810503BM	383,00	62	03411601FU	52,40	326
00611002NE	394,00	59	00628006	286,00	393	00661001NM	459,00	58	00810503NM	383,00	62	03411601GM	52,40	326
00612001	143,00	427	00628006	286,00	434	00661001OM	459,00	58	00810503OM	464,00	62	03411601NA	52,40	326
00612001AC	237,00	64	00628006AC	473,00	67	00661001NM	556,00	58	00810503OR	464,00	62	03411601NE	52,40	326
00612001BL	237,00	64	00628006BM	473,00	67	00661001OR	556,00	58	00810504	239,00	424	03411601NI	52,40	326
00612001BM	237,00	64	00628006NM	473,00	67	00661002	278,00	418	00810504AC	395,00	62	03411601OM	63,45	326
00612001D	162,00	427	00628006OM	573,00	67	00663901	37,90	326	00810504BM	395,00	62	03411601OR	63,45	326
00612001NE	237,00	64	00628006OR	573,00	67	00663901AC	62,50	326	00810504NM	395,00	62	03411601RO	52,40	326
00612001NM	237,00	64	00630001	211,00	426	00663901BL	62,50	326	00810504OM	478,00	62	03411601RU	52,40	326
00612001OM	286,00	64	00630001AC	388,00	63	00663901BM	62,50	326	00810504OR	478,00	62	03411601U	52,40	326
00612001OR	286,00	64	00630001BM	348,00	63	00663901NG	62,50	326	00815101	223,00	426	03412102	177,00	322
00612301	170,00	428	00630001NM	348,00	63	00663901NM	62,50	326	00815201	312,00	426	03412401	32,00	450
00612301	170,00	548	00630001OM	422,00	63	00663901OM	75,75	326	00815301	223,00	427	03412401	32,00	469
00612301AC	281,00	64	00630001OR	422,00	63	00663901OR	75,75	326	00815301AC	368,00	63	03412401	32,00	493
00612301BM	281,00	64	00630002	221,00	426	00681001	326,00	419	00815301BM	368,00	63	03412401	32,00	512
00612301NM	281,00	64	00630002AC	365,00	63	00681001AC	538,00	59	00815301NM	368,00	63	03412401	32,00	549
00612302	207,00	428	00630002BM	365,00	63	00681001BL	538,00	59	00815301OM	445,00	63	03412401AC	52,80	80
00612302	207,00	548	00630002NM	365,00	63	00681001BM	538,00	59	00815301OR	445,00	63	03412401AM	52,80	101
00612402AC	332,00	64	00630002OM	443,00	63	00681001NE	538,00	59	00815401	228,00	427	03412401BM	52,80	80
00612402BM	332,00	64	00630002OR	443,00	63	00681001NM	538,00	59	00815401AC	376,00	63	03412401BM	52,80	101
00612402NM	332,00	64	00630003	267,00	426	00681001NE	538,00	59	00815401BM	376,00	63	03412401NM	52,80	80
00612402OM	402,00	64	00630003AC	440,00	63	00681001OR	651,00	59	00815401NM	376,00	63	03412401NM	52,80	101
00612402OR	402,00	64	00630003BM	440,00	63	00681002	326,00	419	00815401OM	455,00	63	03412402	39,95	428
00613001	121,00	428	00630003NM	440,00	63	00698003	505,00	390	00815401OR	455,00	63	03412402	39,95	548
00616103	421,00	408	00630003OM	534,00	63	00698003	505,00	432	00815401OR	455,00	63	03412402AC	65,90	64
00616103	421,00	436	00630003OR	534,00	63	00712001	143,00	427	01210002	66,95	539	03412402BM	65,90	64
00616103AC	695,00	67	00630011	242,00	425	00712001AC	237,00	64	01210003	71,10	539	03412402NM	65,90	64
00616103BM	695,00	67	00630011AC	399,00	62	00712001BL	237,00	64	01210003	81,40	538	03423101	191,00	320
00616103NM	695,00	67	00630011BM	399,00	62	00712001OR	237,00	64	01210303	127,25	538	03433601	124,00	558
00616103OM	843,00	67	00630011NM	399,00	62	00712001D	162,00	427	01210303	127,25	538	03433603	107,00	559
00616103OR	843,00	67	00630011OM	484,00	62	00712001E	237,00	64	01217901	410,00	543	03433604	144,00	558
00616104	421,00	407	00630011OR	484,00	62	00712001NM	237,00	64	01220002	60,80	541	03443101	292,00	321
00616104	421,00	435	00630012	252,00	425	00712001OM	286,00	64	01220701	238,00	541	03443202	281,00	322
00616105	399,00	408	00630012AC	416,00	62	00712001OR	286,00	64	01220801	68,50	541	03443203	402,00	322
00616105	399,00	436	00630012BM	416,00	62	00715501	74,80	439				03443205	419,00	323
00616105AC	658,00	67	00630012NM	416,00	62	00716402	481,00	362				03452602	107,00	557
00616105BM	658,00	67	00630012OM	505,00	62	007164039BM	561,00	68	02418201	46,25	575	03452702	144,00	557

Ref./Nr./Kod	Price	Page	Ref./Nr./Kod	Price	Page	Ref./Nr./Kod	Price	Page	Ref./Nr./Kod	Price	Page	Ref./Nr./Kod	Price	Page
03463430LV	32,10	166	06110502KM	361,00	114	06183901AM	41,05	332	06228005	711,00	395	09027401	250,00	475
03463430NM	37,90	166	06110502KMB	361,00	76	06183901BL	41,05	332	06228005	711,00	455	09027401	250,00	501
03463430OM	45,85	166	06110502KMB	361,00	114	06183901BM	41,05	332	06228006	278,00	395	09027401	250,00	516
03463430OR	45,85	166	06110502NM	361,00	76	06183901FU	41,05	332	06228006	278,00	455	09049501	502,00	350
03463628	65,85	381	06110502NM	361,00	114	06183901NA	41,05	332	06230001	201,00	448	09096020	560,00	377
03463629	83,70	381	06110502OM	437,00	76	06183901NE	41,05	332	06230002	211,00	448	09096021	756,00	377
03463630	239,80	381	06110502OM	437,00	114	06183901NM	41,05	332	06230011	246,00	448	09096022	549,00	377
03463701	74,60	555	06110502OP	437,00	76	06183901ON	49,75	332	06230012	257,00	448	09096022	549,00	505
03463702	56,00	556	06110502OP	437,00	114	06183901OR	49,75	332	06231201	787,00	347	09096022	549,00	517
03463707	53,85	559	06110502OR	437,00	76	06183901RO	41,05	332	06232801	543,00	285	09096023	560,00	461
03463708	83,85	556	06110502OR	437,00	114	06183901VE	41,05	332	06243701	65,65	318	09096401	230,00	371
03463820AC	40,75	166	06111001	194,00	445	06183901VI	41,05	332	06243201AC	109,00	318	09096401	230,00	460
03463820AL	34,60	166	06112001	131,00	449	06192801	102,00	560	06243201BM	109,00	318	09096401	230,00	475
03463820LV	34,60	166	06112001AC	216,00	79	06193102	117,00	561	06243201KM	109,00	318	09096401	230,00	501
03463820OM	49,35	166	06112001BM	216,00	79	06193103	113,00	560	06243201NM	109,00	318	09096401	230,00	516
03463820OR	49,35	166	06112001D	148,00	449	06193104	137,00	561	06243201OM	132,00	318	09097401	284,00	373
03463901	31,75	326	06112001KM	216,00	79	06193105	133,00	561	06243201OR	132,00	318	09097401	284,00	461
03463901AC	52,40	326	06112001KMB	216,00	79	06210301	131,00	442	062435AC	334,00	173	09097401	284,00	475
03463901AM	52,40	326	06112001NM	216,00	79	0621030D	148,00	442	062435BM	334,00	173	09097401	284,00	501
03463901BL	52,40	326	06112001OM	262,00	79	06210302	115,00	444	062435NM	334,00	173	09097401	284,00	516
03463901BM	52,40	326	06112001OP	262,00	79	0621030D2	135,00	444	062435OM	404,00	173	09217101	263,00	540
03463901FU	52,40	326	06112001OR	262,00	79	06210303	135,00	444	06243601AC	293,00	173	09226201	1.041,00	146
03463901NA	52,40	326	06112001TAM	216,00	79	0621030D3	152,00	444	06243601BM	293,00	173	09226201AC	1.344,00	146
03463901NE	52,40	326	06112001TBL	216,00	79	06211001	194,00	445	06243601NM	293,00	173	09226201LM	1.246,00	146
03463901NM	52,40	326	06112001TFU	216,00	79	06212001	131,00	449	06243601OM	354,00	173	09226201LV	1.246,00	146
03463901RO	52,40	326	06112001TNA	216,00	79	06212001AC	216,00	79	06248702	333,00	176	09226201OR	1.519,00	146
03463901VE	52,40	326	06112001TNE	216,00	79	06212001BM	216,00	79	06248801	220,00	172	09226202	1.017,00	147
03463901VI	52,40	326	06112001TRO	216,00	79	06212001D	148,00	449	06254201	173,00	174	09226202AC	1.302,00	147
03474007	19,95	589	06112001TTE	216,00	79	06212001KM	216,00	79	06254201AC	286,00	174	09226202LM	1.211,00	147
03474501	30,90	165	06112001TVI	216,00	79	06212001KMB	216,00	79	06254201BM	286,00	174	09226202LV	1.211,00	147
03474501AC	51,00	165	06111501	74,70	461	06212001NM	216,00	79	06254201OM	286,00	174	09226202OR	1.469,00	147
03474501LM	43,30	165	06115501	74,70	475	06212001OM	262,00	79	06254201OM	346,00	174	09226301	1.154,00	147
03474501OM	61,80	165	06115501	74,70	505	06212001OP	262,00	79	06290501	225,00	446	09226301AC	1.503,00	147
03474501OR	61,80	165	06115501	74,70	529	06212001OR	262,00	79	06290502	189,00	446	09226301LM	1.386,00	147
03474601	24,75	165	06116101	725,00	413	06212001TAM	216,00	79	06290503	171,00	446	09226301LV	1.386,00	147
03474601AC	40,80	165	06116101	725,00	457	06212001TBL	216,00	79	06298001	496,00	394	09226301OR	1.702,00	147
03474601LM	34,65	165	06116201	219,00	369	06212001TFU	216,00	79	06298001	496,00	454	09226302	1.128,00	148
03474601OM	49,45	165	06116201	219,00	458	06212001TNA	216,00	79	06298004	477,00	393	09226302AC	1.461,00	148
03474601OR	49,45	165	06116201	219,00	487	06212001TNE	216,00	79	06298004	477,00	454	09226302LM	1.351,00	148
03483102	278,00	322	06116209	268,00	369	06212001TRO	216,00	79	06316201	276,00	459	09226302LV	1.351,00	148
03493101	152,00	325	06116209	268,00	458	06212001TVE	216,00	79	06316209	331,00	459	09226302OR	1.651,00	148
03493101AC	252,00	325	06116701	206,00	450	06212001TVI	216,00	79	06317201	363,00	460	09286301	2.525,00	264
03493101BM	252,00	325	06117001	230,00	450	06213001	121,00	449	06317209	416,00	460	09286302	2.472,00	264
03493101NM	252,00	325	06117201	280,00	372	06215001AC	713,00	85	06321101	753,00	345	09286303	2.053,00	266
03493199	109,00	324	06117201	280,00	459	06231602	355,00	408	06331201	787,00	348	09286304	2.000,00	265
03493201	165,00	325	06117201	280,00	487	06231602	355,00	456	06339301	714,00	345	09286305	1.694,00	266
03493201AC	272,00	325	06117202	101,00	592	06231603	344,00	408				09286306	1.641,00	267
03493201BM	272,00	325	06117209	329,00	372	06231603	344,00	456	08113001	121,00	493	09286307	1.429,00	267
03493201NM	272,00	325	06117209	329,00	459	06216402	331,00	362	08115001	399,00	411	09286308	1.376,00	268
03493299	114,00	324	06118201	46,25	575	06216801	240,00	284	08115001	399,00	500	09286308BM	1.996,00	268
03493299AC	190,00	324	06118201AC	76,35	332	06217402	347,00	367	08115001	399,00	500	09286308NM	1.996,00	268
03493299BM	190,00	324	06118201BM	76,35	332	06217702	97,05	452	08116103	328,00	410	09286309	2.436,00	268
03493299NM	190,00	324	06118201KM	76,35	332	06217801	292,00	284	08116103	328,00	499	09286310	2.382,00	269
			06118201KMB	76,35	332	06218002	171,00	452	08116104	317,00	410	09286311	1.994,00	269
			06118201NM	76,35	332	06218003	455,00	288	08116104	317,00	499	09286312	1.942,00	270
06110301	131,00	442	06118201OM	92,50	332	06218003AC	752,00	288	08118001	303,00	402	09286312AC	2.826,00	270
06110301D	148,00	442	06118201OP	92,50	332	06218003BM	752,00	288	08118001	303,00	498	09286312BM	2.826,00	270
06110302	115,00	444	06118201OR	92,50	332	06218003NM	752,00	288	081192	337,00	388	09286313	1.740,00	270
06110302D	135,00	444	06118301	29,95	577	06218006	534,00	289	081192	337,00	495	09286313AC	2.531,00	270
06110303	135,00	444	06120301	15,40	442	06218007	464,00	289	08119301	396,00	397	09286313BM	2.531,00	270
06110303D	152,00	444	06120301D	17,20	442	06218008	414,00	289	08119301	396,00	496	09286314	1.539,00	271
06110501	213,00	76	06120304	20,08	444	06218010	626,00	288	08119302	396,00	396	09286314AC	2.217,00	271
06110501	213,00	114	06120306	231,00	444	06218010AC	1.034,00	288	08119302	396,00	496	09286314BM	2.217,00	271
06110501AC	352,00	76	06120601	20,02	442	06218010BM	1.034,00	288	08119701	435,00	387	09286315	1.606,00	271
06110501AL	352,00	114	06120701	225,00	443	06218010NM	1.034,00	288	08119701	435,00	497	09286315AC	2.332,00	271
06110501BM	352,00	76	06121001	70,08	344	06218011	1.324,00	291	08119702	435,00	388	09286315BM	2.332,00	271
06110501BM	352,00	114	06122001	11										

LIST OF PRODUCT REFERENCES / LISTA DI CODICI ARTICOLI / SEZNAM REFERENC

Ref./Nr./Kód	Price	Page	Ref./Nr./Kód	Price	Page	Ref./Nr./Kód	Price	Page	Ref./Nr./Kód	Price	Page	Ref./Nr./Kód	Price	Page
09286404BM	3.637,00	277	09288313NM	2.531,00	270	09288573	796,00	263	10723603AC	125,00	153	12423605	61,80	160
09286405	2.188,00	278	09288314	1.539,00	271	09288580	1.101,00	250	10723603BM	125,00	153	12423605AC	102,50	160
09286406	2.134,00	278	09288314AC	2.217,00	271	09288581	1.503,00	251	10723603NM	125,00	153	12423606LM	86,55	160
09286407	1.923,00	279	09288314NM	2.217,00	271	09288582	1.165,00	257	10723603OM	151,00	153	12423606LV	86,55	160
09286407AC	2.785,00	279	09288315	1.606,00	271	09288583	1.485,00	258	10723603OR	151,00	153	12423606SOR	124,00	160
09286407BM	2.785,00	279	09288315AC	2.332,00	271	09288584	1.246,00	254	10723606	34,50	154	12423606	44,30	161
09286408	1.871,00	279	09288315NM	2.332,00	271	09288584AC	1.806,00	254	10723606AC	56,90	154	12423606AC	73,10	161
09286408AC	2.722,00	279	09288316	1.404,00	272	09288584NM	1.806,00	254	10723606BM	56,90	154	12423606LM	62,05	161
09286408BM	2.722,00	279	09288316AC	2.019,00	272	09288585	1.942,00	254	10723606NM	56,90	154	12423606LV	62,05	161
09286551	1.045,00	55	09288316NM	2.019,00	272				10723606OM	68,95	154	12423606OR	88,60	161
09286551AC	1.045,00	55	09288317	1.346,00	272	10			10723606OR	68,95	154	12423607	10,30	161
09286551AC	1.491,00	55	09288318	1.143,00	273	104840	41,45	588	10723620	32,80	153	12423607AC	17,00	161
09286551AC	1.491,00	250	09288319	1.485,00	273	104841	41,45	588	10723620AC	54,10	153	12423607LM	14,45	161
09286551BM	1.491,00	55	09288319AC	2.134,00	273	106103	138,00	421	10723620BM	54,10	153	12423607LV	14,45	161
09286551BM	1.491,00	250	09288319NM	2.134,00	273	106103DA	157,00	421	10723620NM	54,10	153	12423607OR	20,60	161
09286552	1.246,00	251	09288320	1.662,00	274	106124	201,00	427	10723620OM	65,55	153	12463604	83,45	161
09286552AC	1.806,00	251	09288320AC	2.403,00	274	10616102	893,00	412	10723620OR	65,55	153	12463608	72,10	160
09286552BM	1.806,00	251	09288320NM	2.403,00	274	10616102	893,00	437	107395	796,00	339	12463609	58,75	160
09286553	980,00	255	09288321	1.189,00	274	106177	117,00	431	107440	275,00	171	12463610	56,65	161
09286553AC	1.413,00	255	09288322	1.367,00	275	10617710	82,10	431	107476	323,00	562	12463611	87,55	160
09286553BM	1.413,00	255	09288401	3.018,00	276	106180	205,00	431	107503	139,00	425	12463612	56,65	161
09286554	1.109,00	90	09288402	2.965,00	276	10618010	111,00	431	107511	82,10	439	12463613	108,00	161
09286554AC	1.109,00	256	09288403	2.546,00	277	10620501	228,00	421	10763608	266,00	154	12463615	99,95	160
09286554AC	1.596,00	90	09288403AC	3.700,00	277	106245	381,00	414	10763623	117,00	154			
09286554AC	1.596,00	256	09288403NM	3.700,00	277	106245	381,00	437	10763627	155,00	154	13		
09286554BM	1.596,00	90	09288404	2.494,00	277	10627701	117,00	431	107839	26,25	576	130335	196,00	179
09286554BM	1.596,00	256	09288404AC	3.637,00	277	10627701AC	188,00	65	107839BM	43,30	332	130336	183,00	173
09286555	1.287,00	258	09288404NM	3.637,00	277	10627701BM	188,00	65	107839NM	43,30	332	13033590	65,75	600
09286555AC	1.877,00	258	09288405	2.188,00	278	10627701NM	188,00	65	107839OM	52,45	332	130432	324,00	178
09286555BM	1.877,00	258	09288406	2.134,00	278	10627701OR	23,00	65	107839OR	52,45	332	130496	233,00	170
09286556	963,00	262	09288407	1.923,00	279	10627701OR	23,00	65	107922	59,35	554	130497	250,00	171
09286556AC	1.401,00	262	09288407AC	2.785,00	279	10628001	205,00	431	107926	319,00	562	130497AM	413,00	171
09286556BM	1.401,00	262	09288407NM	2.785,00	279	10628001AC	328,00	65	107934	179,00	558	130497FU	413,00	171
09286557	1.433,00	259	09288408	1.871,00	279	10628001BM	328,00	65	107935	121,00	555	130497NA	413,00	171
09286557AC	2.090,00	259	09288408AC	2.722,00	279	10628001NM	328,00	65	107940	66,15	583	130497RO	413,00	171
09286557BM	2.090,00	259	09288408NM	2.722,00	279	10628001OM	410,00	65	107964	535,00	343	130497VE	413,00	171
09286558	872,00	260	09288551	1.045,00	255	10628001OR	410,00	65	108124	201,00	428	130497VI	413,00	171
09286558AC	1.259,00	260	09288551AC	1.045,00	255	106437	316,00	177	108496	223,00	423	130498	246,00	170
09286558BM	1.259,00	260	09288551AC	1.491,00	255	106440	275,00	171	108497	232,00	423	134122	199,00	450
09286561	1.449,00	252	09288551AC	1.491,00	255	106486	320,00	170	108498	243,00	181	134122	199,00	512
09286561AC	2.101,00	252	09288551NM	1.491,00	255	106486AM	529,00	170	108604	206,00	422	134122	199,00	549
09286561BM	2.101,00	252	09288551NM	1.491,00	255	106486FU	529,00	170	108605	206,00	423	134123	159,00	540
09286562	1.889,00	252	09288552	1.246,00	251	106486NA	529,00	170	108606	211,00	423	134123	159,00	511
09286563	927,00	253	09288552AC	1.806,00	251	106486OR	529,00	170				134123	159,00	548
09286563AC	1.323,00	253	09288552NM	1.806,00	251	106486VE	529,00	170	11			134123AC	263,00	80
09286563BM	1.323,00	253	09288553	980,00	255	106486VI	529,00	170	112161	200,00	542	134123BM	263,00	80
09286564	897,00	253	09288553AC	1.413,00	255	106603	199,00	421	11216150	111,00	542	134123NM	263,00	80
09286564AC	1.281,00	253	09288553NM	1.413,00	255	106604	226,00	421	112162	384,00	543	13413726	104,00	316
09286564BM	1.281,00	253	09288554	1.109,00	90	106605	220,00	422	112163	394,00	542	13413730	198,00	316
09286565	1.343,00	259	09288554AC	1.109,00	256	106606	231,00	422	112167	90,90	542	13413730AC	327,00	316
09286566	1.874,00	260	09288554AC	1.596,00	90	106607	245,00	422	112177	68,50	543	13413730BM	327,00	316
09286567	854,00	261	09288554AC	1.596,00	256	10691405	171,00	352	112178	79,80	543	13413730KM	327,00	316
09286567AC	1.232,00	261	09288554NM	1.596,00	90	10691405AC	282,00	352	112205	90,05	541	13413730NM	327,00	316
09286567BM	1.232,00	261	09288554NM	1.596,00	256	10691405BM	282,00	352	112206	258,00	541	13413730OM	396,00	316
09286568	897,00	261	09288555	1.287,00	258	10691405NM	282,00	352	1123601	56,65	155	13413730OR	396,00	316
09286570	1.086,00	255	09288555AC	1.877,00	258	106980	589,00	391	11423601AC	93,50	155	13413826	126,00	314
09286570AC	1.520,00	255	09288555NM	1.877,00	258	106980	589,00	432	11423601BM	93,50	155	13413830	227,00	314
09286570BM	1.520,00	255	09288556	963,00	262	107103	138,00	421	11423601NM	93,50	155	13413830AC	374,00	314
09286571	820,00	256	09288556AC	1.401,00	262	10710342	181,00	166	11423601OM	113,00	155	13413830BM	374,00	314
09286573	796,00	263	09288556NM	1.401,00	262	10710342AC	300,00	166	11423601OR	113,00	155	13413830NM	374,00	314
09286580	1.101,00	250	09288557	1.433,00	259	10710342BM	300,00	166	11423602	64,90	155	13413830OM	453,00	314
09286581	1.503,00	251	09288557AC	2.090,00	259	10710342NM	300,00	166	11423602AC	107,00	155	13413830OR	453,00	314
09286582	1.165,00	257	09288557NM	2.090,00	259	10710342OM	363,00	166	11423602BM	107,00	155	13413940	72,20	318
09286583	1.485,00	258	09288558	872,00	260	10710342OR	363,00	166	11423602NM	107,00	155	13413940AC	120,00	318
09286584	1.246,00	254	09288558AC	1.259,00	260	107103DA	157,00	421	11423602OM	130,00	155	13413940BM	120,00	318
09286584AC	1.806,00	254	09288558NM	1.259,00	260	107131	319,00	562	11423602OR	130,00	155	13413940NM	120,00	318
09286584BM	1.806,00	254	09288561	1.449,00	252	10716102	893,00	412	114444	241,00	178	13413940OM	145,00	318
09286585	1.942,00	254	09288561AC	2.101,00	252	10716102	893,00	437	11463609	37,10	156	13413940OR	145,00	318
09288301	2.525,00	264	09288561NM	2.101,00	252	107164	304,00	368	11463609AC	61,20	156	13416703	68,35	543
09288302	2.472,00	264	09288562	1.889,00	252	107164	304,00	438	11463609BM	61,20	156	13416803	87,90	543
09288303	2.053,00	266	09288563	927,00	253	1071649	340,00	368	11463609NM	61,20	156	13418183	61,80	547
09288304	2.000,00	265	09288563AC	1.323,00	253	1071649	340,00	438	11463609OM	74,20	156	134184	25,75	156
09288305	1.694,00	266	09288563NM	1.323,00	253	107167	265,00	429	11463609OR	74,20	156	13418440	30,90	157

Ref./Nr./Kód	Price	Page	Ref./Nr./Kód	Price	Page	Ref./Nr./Kód	Price	Page	Ref./Nr./Kód	Price	Page	Ref./Nr./Kód	Price	Page	
134315005	103,00	316	13462104OR	123,00	318	16123601AC	100,00	155	18118005	157,00	498	193223	572,00	380	
134315006	113,00	315	13462202	61,80	319	16123601BM	100,00	155	181191	396,00	388	20	20011011	137,00	465
134315007	165,00	315	13462202AC	102,00	319	16123601NM	100,00	155	181192	396,00	387		20011011D	162,00	465
134315007AC	280,00	315	13462202BM	102,00	319	16123601OR	122,00	155	1811902	396,00	384	20011012	137,00	464	
134315007BM	280,00	315	13462202NM	102,00	319	16123602AC	108,00	155	1811902	396,00	397	2001102D	162,00	464	
134315007NM	280,00	315	13462202OR	124,00	319	16123602BM	65,75	155	1811902	142,00	351	20010301	115,00	465	
134315007OM	340,00	315	13462202OR	124,00	319	16123602NM	108,00	155	181200	246,00	492	20010301AC	191,00	95	
134315007OR	340,00	315	134628	106,00	560	16123602OR	132,00	155	181203	120,00	490	20010301BM	191,00	95	
134315008	258,00	315	134629	122,00	560	16123606AC	61,20	155	181207	225,00	491	20010301OR	191,00	95	
134315009	93,60	316	13463310	12,15	587	16123606BM	61,20	155	181217	194,00	490	20010301NM	191,00	95	
134315010	118,00	317	13463410	36,95	590	16123606NM	61,20	155	181222	195,00	493	20010301OR	191,00	95	
134315011	112,00	314	13463420	53,90	590	16123606OR	61,20	155	181222	195,00	499	20010301BM	191,00	95	
134315012	131,00	315	13463430	22,95	166	16123606AC	61,20	155	181223	158,00	493	20010301D	138,00	465	
134331	239,00	323	13463450	20,90	587	16123606BM	61,20	155	181223	158,00	492	20010301VI	191,00	95	
13434010	26,20	583	13463460	4,10	590	16123606OR	61,20	155	181224	163,00	499	20010301NA	191,00	95	
13434020	26,20	586	13463624	57,70	156	16123606NM	61,20	155	181303	190,00	491	20010301NE	191,00	95	
13434120	26,20	585	13463810	19,70	590	16123606OR	74,20	155	181341	134,00	532	20010301NM	191,00	95	
134345	396,00	414	13463820	24,70	166	16123620	13,40	157	181385	436,00	357	20010301OM	231,00	95	
134345	396,00	458	134714	426,00	313	16123620AC	22,10	157	181385	436,00	502	20010301OR	231,00	95	
134432	259,00	321	134715	426,00	312	16123620BM	22,10	157	181385	436,00	516	20010301RO	191,00	95	
134433	300,00	320	13474010	18,10	588	16123620NM	22,10	157	18138502	422,00	356	20010301VE	191,00	95	
134445	86,00	415	13474020	7,80	589	16123620OR	26,80	157	18138502	422,00	502	20010301VI	191,00	95	
134445	86,00	436	13474110	20,25	595	16123620OR	26,80	157	18138503	422,00	359	20010302	115,00	464	
134445	86,00	437	13474210	11,20	593	161445	246,00	180	18138503	422,00	503	20010302AC	191,00	94	
134445	86,00	456	13474220	13,65	593	161446	289,00	180	18138506	102,00	351	20010302AM	191,00	94	
134445	86,00	458	13474310	14,90	587	161475	217,00	563	18138506AC	169,00	351	20010302BL	191,00	94	
134445	86,00	473	134748	41,50	568	161476	278,00	563	18138506BM	169,00	351	20010302BM	191,00	94	
134445	86,00	486	134757	20,85	577	16163615	78,30	158	18138506NM	169,00	351	20010302D	138,00	464	
134445	86,00	499	134846	95,15	588	16163616	45,35	157	181386	415,00	507	20010302F	191,00	94	
134445	86,00	500	134870	76,90	594	16163618	68,00	156	181386	415,00	503	20010302NA	191,00	94	
134445	86,00	514	134871	88,75	594	16163623	95,80	156	181403	177,00	491	20010302NE	191,00	94	
13445301	69,80	535	134873	18,60	577	16163624	111,00	156	181436	180,00	532	20010302NM	191,00	94	
13446302	102,00	352	134903	861,00	313	161839	24,90	576	181437	213,00	533	20010302OM	231,00	94	
134512	92,35	558	134940	727,00	310	161840	37,95	583	181438	213,00	533	20010302OR	231,00	94	
134516	59,40	554	13494010	53,45	584	162113	167,00	512	181468	145,00	494	20010302RO	191,00	94	
134517	92,35	554	134940AC	1.200,00	310	162113	167,00	550	181474	158,00	494	20010302VE	191,00	94	
134520	92,35	554	134940BM	1.200,00	310	162161	725,00	413	181540	195,00	532	20010302VI	191,00	94	
13452102	40,50	319	134940NM	1.200,00	310	162161	725,00	457	181703	165,00	491	20011001	194,00	466	
13452102AC	66,80	319	134940OM	1.454,00	310	16216150	376,00	591	18188005	320,00	402	20011001AM	320,00	96	
13452102BM	66,80	319	134940OR	1.454,00	310	162245	381,00	414	18188005	320,00	498	20011001BL	320,00	96	
13452102KM	66,80	319	13494110	55,30	584	162245	381,00	457	181903	95,00	490	20011001F	320,00	96	
13452102NM	66,80	319	13494210	58,75	584	16235590	60,40	535	181920	103,00	492	20011001NA	320,00	96	
13452102OM	81,00	319	134944	664,00	309	162435	202,00	173	183341	126,00	532	20011001NE	320,00	96	
13452102OR	81,00	319	134944AC	1.097,00	309	162436	177,00	173	183395	257,00	363	20011001RO	320,00	96	
134522	125,00	559	134944BM	1.097,00	309	162437	209,00	177	183398	317,00	367	20011001VE	320,00	96	
13452202	51,50	319	134944NM	1.097,00	309	162438	209,00	177	186103	108,00	490	20011001VI	320,00	96	
13452202AC	85,00	319	134944OM	1.329,00	309	162440	151,00	175	186120	112,00	492	20011002	194,00	466	
13452202BM	85,00	319	134944OR	1.329,00	309	162441	178,00	532	186203	136,00	490	20011002AM	320,00	96	
13452202NM	85,00	319	134950	889,00	310	162442	155,00	532	186207	240,00	491	20011002BL	320,00	96	
13452202OM	103,00	319	134950AC	1.467,00	310	162453	323,00	535	186217	210,00	490	20011002F	320,00	96	
13452202OR	103,00	319	134950BM	1.467,00	310	162456	250,00	535	186903	112,00	490	20011002NA	320,00	96	
134526	92,35	557	134950NM	1.467,00	310	162540	200,00	174	186920	117,00	492	20011002NE	320,00	96	
134527	125,00	557	134950OM	1.778,00	310	162541	211,00	173	18718250	398,00	591	20011002RO	320,00	96	
13453410	30,15	588	134950OR	1.778,00	310	162840	30,15	583	187444	268,00	178	20011002VE	320,00	96	
13453420	23,50	165	134951	889,00	308	163103	214,00	447	189245	288,00	415	20011002VI	320,00	96	
13453430	53,80	165	134951AC	1.467,00	308	163120	220,00	449	189245	381,00	500	20012001	117,00	468	
13453440	71,80	165	134951BM	1.467,00	308	163145	518,00	411				20012001AC	195,00	100	
13454010	22,70	583	134951NM	1.467,00	308	163145	518,00	458				20012001AM	195,00	100	
13454030	32,80	585	134951OM	1.778,00	308	163151	280,00	448	190162	180,00	370	20012001BL	195,00	100	
13454050	21,80	584	134951OR	1.778,00	308	163152	270,00	448	1901629	226,00	370	20012001BM	195,00	100	
13454060	21,40	584				163194	619,00	451	190172	224,00	372	20012001D	140,00	468	
13454070	19,90	584				163333	230,00	181	1901729	270,00	373	20012001F	195,00	100	
13454110	18,70	586	16110342	156,00	166	163868	272,00	451	190186	145,00	369	20012001NA	195,00	100	
13454160	21,40	586	16110342AC	258,00	166	163874	345,00	451	190213	476,00	360	20012001NE	195,00	100	
13454190	19,90	586	16110342BM	258,00	166	168103	232,00	447	190213	476,00	504	20012001NM	195,00	100	
134550	230,00	390	16110342KM	258,00	166	168105	351,00	447	19021302	476,00	504	20012001OM	235,00	100	
134550	230,00	453	16110342KMB	258,00	166	168120	239,00	449	19021302	476,00	504	20012001OR	235,00	100	
134552	28,10	588	16110342NM	258,00	166				190214	481,00	508	20012001RO	195,00	100	
134612	15,35	567	16110342OM	311,00	166				190214	4					

LIST OF PRODUCT REFERENCES / LISTA DI CODICI ARTICOLI / SEZNAM REFERENC

Ref./Nr./Kód	Price	Page	Ref./Nr./Kód	Price	Page	Ref./Nr./Kód	Price	Page	Ref./Nr./Kód	Price	Page	Ref./Nr./Kód	Price	Page
20013001	121,00	480	20018001NM	282,00	103	20020304NA	344,00	94	20020504NM	272,00	97	20030002OR	429,00	99
20016201	381,00	409	20018001OM	342,00	103	20020304NE	344,00	94	20020504OM	330,00	97	20031201	705,00	347
20016201	381,00	473	20018001OR	342,00	103	20020304NM	344,00	94	20020504OR	330,00	97	20044001	250,00	172
20016201AC	629,00	104	20018001RO	282,00	103	20020304OM	416,00	94	20020504RO	272,00	97	20044001AC	379,00	172
20016201BM	629,00	104	20018001VE	282,00	103	20020304OR	416,00	94	20020504VE	272,00	97	20044001AM	379,00	172
20016201NM	629,00	104	20018001VI	282,00	103	20020304RO	344,00	94	20020504VI	272,00	97	20044001BL	379,00	172
20016201OM	762,00	104	20018002	419,00	396	20020304VE	344,00	94	20020505	171,00	467	20044001BM	379,00	172
20016201OR	762,00	104	20018002	419,00	471	20020304VI	344,00	94	20020505AC	282,00	97	20044001FO	379,00	172
20016203	356,00	409	20018002AM	692,00	103	20020305	231,00	465	20020505AM	282,00	97	20044001HA	379,00	172
20016203	356,00	473	20018002BL	692,00	103	20020305AC	381,00	96	20020505BL	282,00	97	20044001IN	379,00	172
20016203AC	588,00	104	20018002FU	692,00	103	20020305AM	381,00	96	20020505BM	282,00	97	20044001NM	379,00	172
20016203BM	588,00	104	20018002NA	692,00	103	20020305BL	381,00	96	20020505FU	282,00	97	20044001OM	459,00	172
20016203NM	588,00	104	20018002NE	692,00	103	20020305BM	381,00	96	20020505NA	282,00	97	20044001RO	379,00	172
20016203OM	713,00	104	20018002RO	692,00	103	20020305FU	381,00	96	20020505NE	282,00	97	20044001VI	379,00	172
20016203OR	713,00	104	20018002VE	692,00	103	20020305NA	381,00	96	20020505OM	282,00	97	20044001VI	379,00	172
20016401	219,00	368	20018002VI	692,00	103	20020305NE	381,00	96	20020505OR	342,00	97	20044002	180,00	174
20016401	219,00	474	20018005	692,00	398	20020305NM	381,00	96	20020505OR	342,00	97	20044002AC	298,00	174
20016409	268,00	368	20018005	692,00	472	20020305OM	461,00	96	20020505RO	282,00	97	20044002AM	298,00	174
20016409	268,00	474	20018005AC	1.108,00	103	20020305OR	461,00	96	20020505VE	282,00	97	20044002BL	298,00	174
20016409AC	442,00	104	20018005BM	1.108,00	103	20020305RO	381,00	96	20020505VI	282,00	97	20044002BM	298,00	174
20016409AM	442,00	104	20018005NM	1.108,00	103	20020305VE	381,00	96	20020506	176,00	467	20044002FU	298,00	174
20016409BL	442,00	104	20018005OM	1.343,00	103	20020305VI	381,00	96	20020506AC	292,00	98	20044002NA	298,00	174
20016409BM	442,00	104	20018005OR	1.343,00	103	20020306	231,00	465	20020506AM	292,00	98	20044002NE	298,00	174
20016409FU	442,00	104	20018007	419,00	396	20020306AC	381,00	95	20020506BL	292,00	98	20044002NM	298,00	174
20016409NA	442,00	104	20018007	419,00	471	20020306AM	381,00	95	20020506BM	292,00	98	20044002RO	298,00	174
20016409NE	442,00	104	20018009	399,00	397	20020306BL	381,00	95	20020506FU	292,00	98	20044002VE	298,00	174
20016409NM	442,00	104	20018009	399,00	472	20020306BM	381,00	95	20020506NA	292,00	98	20044002VI	298,00	174
20016409OM	536,00	104	20018010	85,35	470	20020306FU	381,00	95	20020506NE	292,00	98	20047501	217,00	565
20016409OR	536,00	104	20018011	419,00	396	20020306NA	381,00	95	20020506OM	292,00	98	20050301	104,00	447
20016409RO	442,00	104	20018011	419,00	471	20020306NE	381,00	95	20020506OR	352,00	98	20050301	104,00	468
20016409VE	442,00	104	20018080	399,00	397	20020306NM	381,00	95	20020506RO	352,00	98	20050310AC	172,00	100
20016409VI	442,00	104	20018080	399,00	472	20020306OM	461,00	95	20020506VE	292,00	98	20050310BM	172,00	100
20016701	206,00	470	20018201	46,25	575	20020306OR	461,00	95	20020506VI	292,00	98	20050310NM	172,00	100
20016701AC	340,00	102	20018201AC	76,35	331	20020306RO	381,00	95	20020506VI	292,00	98	20050310OM	208,00	100
20016701AM	340,00	102	20018201AM	76,35	331	20020306VE	381,00	95	20020506VI	158,00	469	20050310OR	208,00	100
20016701BL	340,00	102	20018201BL	76,35	331	20020306VI	381,00	95	20022401AC	261,00	101	20063606	103,00	158
20016701BM	340,00	102	20018201BM	76,35	331	20020501	171,00	467	20022401AM	261,00	101	20063607	66,95	159
20016701FU	340,00	102	20018201FU	76,35	331	20020501AC	282,00	98	20022401BL	261,00	101	20063608	101,00	159
20016701NA	340,00	102	20018201NA	76,35	331	20020501AM	282,00	98	20022401BM	261,00	101	20063609	58,75	159
20016701NE	340,00	102	20018201NE	76,35	331	20020501BL	282,00	98	20022401FU	261,00	101	20063610	175,00	158
20016701NM	340,00	102	20018201NM	76,35	331	20020501BM	282,00	98	20022401NA	261,00	101	20063611	128,00	158
20016701OM	412,00	102	20018201OM	92,50	331	20020501FU	282,00	98	20022401NE	261,00	101	20116701	238,00	284
20016701OR	412,00	102	20018201OR	92,50	331	20020501NA	282,00	98	20022401NM	261,00	101	20117001	289,00	284
20016701RO	340,00	102	20018201RO	76,35	331	20020501NE	282,00	98	20022401OM	315,00	101	20117701	136,00	286
20016701VE	340,00	102	20018201VE	76,35	331	20020501NM	282,00	98	20022401OR	315,00	101	20117702	126,00	286
20016701VI	340,00	102	20018201VI	76,35	331	20020501OM	342,00	98	20022401RO	261,00	101	20117703	292,00	291
20017001	239,00	470	20018301	29,95	577	20020501OR	342,00	98	20022401VE	261,00	101	20117704	385,00	288
20017001AC	395,00	102	20019501	657,00	342	20020501RO	282,00	98	20022401VI	261,00	101	20118001	188,00	286
20017001AM	395,00	102	20019501AM	1.085,00	105	20020501VE	282,00	98	20023604	141,00	157	20118001AC	310,00	286
20017001BL	395,00	102	20019501BL	1.085,00	105	20020502	189,00	467	20023604AC	238,00	157	20118001BM	310,00	286
20017001BM	395,00	102	20019501BL	1.085,00	105	20020502AC	311,00	99	20023604BM	238,00	157	20118001NM	310,00	286
20017001FU	395,00	102	20019501FU	1.085,00	105	20020502AM	311,00	99	20023604NM	238,00	157	20118002	176,00	286
20017001NA	395,00	102	20019501FU	1.085,00	105	20020502BL	311,00	99	20023604OM	288,00	157	20118003	364,00	290
20017001NM	395,00	102	20019501NA	1.085,00	105	20020502BM	311,00	99	20023604OR	288,00	157	20118004	398,00	290
20017001OM	478,00	102	20019501NA	1.085,00	105	20020502OM	311,00	99	20023605	175,00	158	20118006	410,00	287
20017001OR	478,00	102	20019501NE	1.085,00	105	20020502OR	311,00	99	20023605AC	289,00	158	20118007	503,00	287
20017001RO	395,00	102	20019501NE	1.085,00	105	20020502NA	311,00	99	20023605AM	289,00	158	20119501	517,00	285
20017001VE	395,00	102	20019501NE	1.085,00	105	20020502NM	311,00	99	20023605BL	289,00	158	20120301	143,00	43
20017001VI	395,00	102	20019501RO	1.085,00	105	20020502OM	377,00	99	20023605BM	289,00	158	20120301AC	237,00	43
20017401	280,00	371	20019501RO	1.085,00	105	20020502OR	377,00	99	20023605OM	350,00	158	20120301BL	237,00	43
20017401	280,00	474	20019501VE	1.085,00	105	20020502OR	377,00	99	20023612	52,90	158	20120301BM	237,00	43
20017409	337,00	371	20019501VE	1.085,00	105	20020502RO	311,00	99	20023612AC	87,30	158	20120301D	163,00	43
20017409	337,00	474	20019501VI	1.085,00	105	20020502VE	311,00	99	20023612BM	87,30	158	20120301NE	237,00	43
20017409AC	556,00	105	20019501VI	1.085,00	105	20020502VI	311,00	99	20023612NM	87,30	158	20120301NM	237,00	43
20017409AM	556,00	105	20019502	606,00	342	20020503	225,00	467	20023612OM	106,00	158	20120301OM	286,00	43
20017409BL	556,00	105	20019503	657,00	342	20020503AC	371,00	99	20023612OR	106,00	158	20120301OR	286,00	43
20017409BM	556,00	105	20020303	208,00	465	20020503AM	371,00	99	20023613	30,90	159	20120302	143,00	42
20017409FU	556,00	105	20020303AC	344,00	95	20020503BL	371,00	99	20023613AC	51,00	159	20120302D	163,00	42
20017409NA	556,00	105	20020303AM	344,00	95	20020503BM	371,00	99	20023613BM	51,00	159	20120303	277,00	43
20017409NE	556,00	105	20020303BL	344,00	95	20020503FU	371,00	99	20023613NM	51,00	159	20120303AC	457,00	43
20017409NM	556,00	105	20020303BM	344,00	95	20020503NA	371,00	99	20023613OM	61,80	159	20120303BL	457,00	43
20017409OM	556,00	105	20020303FU	344,00	95	20020503NE	371,00	99	20023613OR	61,80	159	20120303BM	457,00	43
20017409OR	674,00	105	20020303NA	344,00	95	20020503NM	371,							

Ref./Nr./Kod	Price	Page	Ref./Nr./Kod	Price	Page	Ref./Nr./Kod	Price	Page	Ref./Nr./Kod	Price	Page	Ref./Nr./Kod	Price	Page
20210501	299,00	44	20223604AC	160,00	152	20230002BM	339,00	45	20316701	132,00	512	20511201	101,00	538
20210501AC	495,00	44	20223604BM	160,00	152	20230002NM	339,00	45	20317001	150,00	512	20511202	138,00	538
20210501BM	495,00	44	20223604NM	160,00	152	20230002OM	412,00	45	20317701	75,10	513	20512001	92,60	480
20210501OM	495,00	44	20223604OR	194,00	152	20230002OR	412,00	45	20318001	142,00	513	20512001D	109,00	480
20210501OR	597,00	44	20223604OR	194,00	152	20230003	216,00	46	20318002	303,00	402	20516101	332,00	410
20210501OR	597,00	44	20223605	118,00	152	20230003AC	357,00	46	20318002	303,00	513	20516101	332,00	486
2021001	251,00	43	20223605AC	196,00	152	20230003BM	357,00	46	20319101	383,00	389	20516103	321,00	410
2021001BL	415,00	43	20223605BM	196,00	152	20230003NM	357,00	46	20319101	383,00	513	20516103	321,00	486
2021001NE	415,00	43	20223605NM	196,00	152	20230003OM	434,00	46	20320001	246,00	510	205164019	249,00	369
20211002	251,00	43	20223605OM	237,00	152	20230003OR	433,00	46	20320002	240,00	510	205164019	249,00	487
2021002BL	415,00	43	20223605OR	237,00	152	20230004	233,00	46	20320003	120,00	509	20516701	116,00	480
2021002NE	415,00	43	20223612	37,10	152	20230004AC	373,00	46	20320301D	136,00	509	20517001	135,00	480
2021001	151,00	46	20223612AC	61,20	152	20230004BM	373,00	46	20320701	225,00	509	205174019	308,00	372
2021001AC	250,00	46	20223612BM	61,20	152	20230004NM	373,00	46	20320701D	240,00	509	205174019	308,00	487
2021001BL	250,00	46	20223612NM	61,20	152	20230004OM	453,00	46	20321001	228,00	510	20517701	72,55	481
2021001BM	250,00	46	20223612OR	74,20	152	20230004OR	453,00	46	20321701	194,00	509	20518001	122,00	481
2021001D	170,00	46	20223612OR	74,20	152	20230011	227,00	45	20321701D	210,00	509	20518002	356,00	399
2021001NE	250,00	46	20223613	26,00	153	20230011AC	374,00	45	20322401	163,00	511	20518002	356,00	483
2021001NM	250,00	46	20223613AC	42,85	153	20230011BM	374,00	45	20324501	381,00	414	20518006	356,00	399
2021001OM	303,00	46	20223613BM	42,85	153	20230011NM	374,00	45	20324501	381,00	456	20518006	356,00	482
2021001OR	303,00	46	20223613NM	42,85	153	20230011OM	453,00	45	20324501	381,00	473	20518007	337,00	400
20212002	151,00	46	20223613OR	51,95	153	20230011OR	453,00	45	20324501	381,00	499	20518007	337,00	484
20212002D	170,00	46	20223613OM	51,95	153	20230012	237,00	45	20324501	381,00	514	20518201	46,25	575
20216101	432,00	50	20223801	223,00	44	20230012AC	390,00	45	20326100	279,00	510	20518201AC	76,35	332
20216101AC	713,00	50	20223801AC	367,00	44	20230012BM	390,00	45	20330301	190,00	509	20518201BM	76,35	332
20216101BM	713,00	50	20223801BM	367,00	44	20230012NM	390,00	45	20340301	177,00	509	20518201KM	76,35	332
20216101NM	713,00	50	20223801NM	367,00	44	20230012OM	474,00	45	20370301	165,00	509	20518201KMB	76,35	332
20216101OM	863,00	50	20223801OM	445,00	44	20230012OR	474,00	45	20390301	98,50	508	20518201NM	76,35	332
20216101OR	863,00	50	20223801OR	445,00	44	20230013	247,00	45	20390301D	113,00	508	20518201OM	92,50	332
20216102	432,00	50	20223901	228,00	44	20230013AC	425,00	45	20392001	103,00	511	20518201OP	92,50	332
20216103	420,00	50	20223901AC	367,00	44	20230013BM	425,00	45	20392001D	117,00	511	20518201OR	92,50	332
20216103AC	694,00	50	20223901BM	367,00	44	20230013NM	425,00	45	20410301	60,15	520	20518301	29,95	577
20216103BM	694,00	50	20223901NM	367,00	44	20230013OM	515,00	45	20410301D	72,20	520	20522201	195,00	469
20216103NM	694,00	50	20223901OM	445,00	44	20230013OR	515,00	45	20412001	61,25	521	20522201	195,00	548
20216103OM	841,00	50	20223901OR	445,00	44	20230014	258,00	45	20412001D	73,30	521	20522301	158,00	469
20216103OR	841,00	50	20224501	388,00	414	20230014AC	441,00	45	20416701	97,35	521	20522301	158,00	548
20216104	420,00	50	20227701	126,00	48	20230014BM	441,00	45	20417001	108,00	521	20522301AC	260,00	101
20216409	356,00	52	20227701AC	201,00	48	20230014NM	441,00	45	20417701	64,55	522	20522301BM	261,00	101
20216409AC	588,00	52	20227701BM	201,00	48	20230014OM	536,00	45	20418001	108,00	522	20522301NM	261,00	101
20216409BL	588,00	52	20227701NM	201,00	48	20230014OR	536,00	45	20418002	255,00	403	20522701	76,15	481
20216409BM	588,00	52	20227701OM	251,00	48	20231201	886,00	53	20418002	255,00	523	20528001	128,00	481
20216409NE	588,00	52	20227701OR	251,00	48	20231201	886,00	346	20418004	255,00	403	20528003	337,00	399
20216409NM	588,00	52	20228001	214,00	48	20238501	662,00	53	20418004	255,00	523	20528003	337,00	483
20216409OM	713,00	52	20228001AC	343,00	48	20238501	662,00	343	20418005	247,00	404	20528004	356,00	398
20216409OR	713,00	52	20228001BM	343,00	48	20238502	715,00	53	20418005	247,00	524	20528004	356,00	482
20216701	279,00	47	20228001NM	343,00	48	20238502	715,00	348	20419601	135,00	370	20528005	782,00	400
20216701AC	461,00	47	20228001OM	429,00	48	20261301	278,00	44	20419601	135,00	525	20528005	782,00	484
20216701BL	461,00	47	20228001OR	429,00	48	20261301AC	459,00	44	20419602	194,00	363	20528006	283,00	401
20216701BM	461,00	47	20228003	546,00	48	20261301BM	459,00	44	20419603	156,00	370	20528006	283,00	485
20216701NE	461,00	47	20228003AC	901,00	48	20261301NM	459,00	44	20419603	156,00	525	20528030	337,00	400
20216701NM	461,00	47	20228003BM	901,00	48	20261301OM	556,00	44	20427701	67,80	522	20528030	337,00	483
20216701OM	558,00	47	20228003NM	901,00	48	20261301OR	556,00	44	20428001	114,00	522	20528040	356,00	398
20216701OR	558,00	47	20228003OM	1.092,00	48	20261302	309,00	44	20428003	247,00	404	20528040	356,00	482
20217001	308,00	47	20228003OR	1.092,00	48	20261302AC	510,00	44	20428003	247,00	524	20528050	782,00	401
20217001AC	509,00	47	20228004	572,00	48	20261302BM	510,00	44	20428004	255,00	403	20528050	782,00	484
20217001BL	509,00	47	20228004AC	943,00	48	20261302NM	510,00	44	20428004	255,00	523	20528060	283,00	401
20217001BM	509,00	47	20228004BM	943,00	48	20261302OM	618,00	44	20428005	451,00	404	20528060	283,00	485
20217001NE	509,00	47	20228004NM	943,00	48	20261302OR	618,00	44	20428005	451,00	524	20530001	185,00	479
20217001NM	509,00	47	20228004OM	1.143,00	48	20263607	69,05	152	20428006	273,00	405	20530002	196,00	479
20217001OM	616,00	47	20228004OR	1.143,00	48	20263608	103,00	152	20428006	273,00	525	20530011	204,00	479
20217001OR	616,00	47	20228005	646,00	49	20263609	60,80	153	20430001	188,00	520	20530012	226,00	479
20217409	410,00	52	20228005AC	1.066,00	49	20263611	125,00	152	20430002	168,00	520	20531201	705,00	347
20217409AC	677,00	52	20228005BM	1.066,00	49	20263901	40,35	326	20438501	293,00	364	20538501	624,00	341
20217409BL	677,00	52	20228005NM	1.066,00	49	20263901AC	66,55	326	20438501	293,00	529	20538502	624,00	341
20217409BM	677,00	52	20228005OM	1.292,00	49	20263901BL	66,55	326	20438503	293,00	364	20539501	658,00	340
20217409NE	677,00	52	20228005OR	1.292,00	49	20263901BM	66,55	326	20438503	293,00	528	20539502	573,00	340
20217409NM	677,00	52	20228006	887,00	49	20263901KM	66,55	326	20438701	422,00	359	20544001	166,00	174
20217409OM	820,00	52	20228006AC	1.463,00	49	20263901NE	66,55	326	20438701	422,00	367	20544001AC	274,00	174
20217409OR	820,00	52	20228006BM	1.463,00	49	20263901NM	66,55	326	20438702	422,00	361	20544001BM	274,00	174
20219101	676,00	47	20228006NM	1.463,00	49	20263901OM	80,65	326	20438702	422,00	528	20544001NM	274,00	174
20219101AC	1.116,00	47	20228006OM	1.774,00	49	20263901OR	80,65	326	20438703	467,00	359	20544001OM	332,00	174
20219101BM	1.116,00	47	20228006OR	1.774,00	49	20266101	802,00	51	20438703	467,00	527	20548601	212,00	172
20219101NM	1.116,00	47	20228007	294,00	49	20266102	802,00	51	20438704	467,00	361	20548601AC	350,00	172
20219501	858,00	52	20228007AC	484,00	49	20310301	76,20	508	20438708	422,00				

LIST OF PRODUCT REFERENCES / LISTA DI CODICI ARTICOLI / SEZNAM REFERENC

Ref./Nr./Kód	Price	Page	Ref./Nr./Kód	Price	Page	Ref./Nr./Kód	Price	Page	Ref./Nr./Kód	Price	Page	Ref./Nr./Kód	Price	Page
20625191NM	1.100,00	232	20635201NM	1.409,00	124	20718201OM	113,00	331	20725211	787,00	192	20735201BM	1.409,00	199
20625191OM	1.333,00	232	20635201NM	1.409,00	236	20718201OR	113,00	249	20725219	666,00	190	20735201KM	1.409,00	89
20625191OR	1.333,00	232	20635202	1.047,00	125	20718201OR	113,00	296	20725291AC	1.100,00	190	20735201KM	1.409,00	89
20625199	536,00	230	20635202	1.047,00	237	20718201OR	113,00	331	20725291BM	1.100,00	190	20735201KMB	1.409,00	89
20625199AC	884,00	230	20635202AC	1.727,00	125	20718202	112,00	187	20725291NM	1.100,00	190	20735201KMB	1.409,00	89
20625199BM	884,00	230	20635202AC	1.727,00	237	20718202	112,00	231	20725291OM	1.333,00	190	20735201NM	1.409,00	89
20625199NM	884,00	230	20635202BM	1.727,00	125	20718202	112,00	331	20725291OR	1.333,00	190	20735201NM	1.409,00	89
20625199OM	1.071,00	230	20635202BM	1.727,00	237	20718202AC	185,00	187	20725292	796,00	190	20735201OM	1.708,00	89
20625199OR	1.071,00	230	20635202NM	1.727,00	125	20718202AC	185,00	231	20725299	536,00	186	20735201OM	1.708,00	89
20625201	890,00	234	20635202NM	1.727,00	237	20718202AC	185,00	331	20725299AC	884,00	186	20735201OP	1.708,00	89
20625201AC	1.469,00	234	20635203	1.351,00	238	20718202BM	185,00	187	20725299BM	884,00	186	20735201OP	1.708,00	89
20625201BM	1.469,00	234	20635203AC	2.230,00	238	20718202BM	185,00	231	20725299NM	884,00	186	20735201OR	1.708,00	89
20625201NM	1.469,00	234	20635203BM	2.230,00	238	20718202BM	185,00	331	20725299OM	1.071,00	186	20735201OR	1.708,00	89
20625202	976,00	235	20635203NM	2.230,00	238	20718202NM	185,00	187	20725299OR	1.071,00	186	20735201TAM	1.409,00	89
20625202AC	1.612,00	235	20635204	1.257,00	125	20718202NM	185,00	231	20725300	1.634,00	208	20735201TAM	1.409,00	89
20625202BM	1.612,00	235	20635204AC	1.257,00	125	20718202NM	185,00	331	20725300AC	1.473,00	208	20735201TBL	1.409,00	89
20625202NM	1.612,00	235	20635204AC	2.073,00	125	20718202OM	225,00	187	20725302AC	2.431,00	208	20735201TBL	1.409,00	89
20625203	1.307,00	236	20635204AC	2.073,00	237	20718202OM	225,00	331	20725302BM	2.431,00	208	20735201TFU	1.409,00	89
20625203AC	2.157,00	236	20635204BM	2.073,00	125	20718202OM	225,00	187	20725302NM	2.431,00	208	20735201TFU	1.409,00	89
20625203BM	2.157,00	236	20635204BM	2.073,00	237	20718202OR	225,00	187	20725303	1.634,00	209	20735201TNA	1.409,00	89
20625203NM	2.157,00	236	20635204NM	2.073,00	125	20718202OR	225,00	331	20725303AC	2.696,00	209	20735201TNA	1.409,00	89
20625204	1.211,00	234	20635204NM	2.073,00	237	20718202OR	225,00	331	20725303BM	2.696,00	209	20735201TNE	1.409,00	89
20625204AC	1.999,00	234	20635291	679,00	233	20719201	951,00	197	20725303NM	2.696,00	209	20735201TNE	1.409,00	89
20625204BM	1.999,00	234	20635291AC	1.121,00	233	20719201AC	1.569,00	197	20725304	2.478,00	212	20735201TRO	1.409,00	89
20625204NM	1.999,00	234	20635291BM	1.121,00	233	20719201BM	1.569,00	197	20725305	1.499,00	213	20735201TRO	1.409,00	89
20625291	666,00	233	20635291NM	1.121,00	233	20719201NM	1.569,00	197	20725305AC	1.743,00	213	20735201TVE	1.409,00	89
20625291AC	1.100,00	233	20635291OM	1.358,00	233	20719201OM	1.901,00	197	20725306	2.072,00	213	20735201TVE	1.409,00	89
20625291BM	1.100,00	233	20635291OR	1.358,00	233	20719201OR	1.901,00	197	20725307	2.343,00	214	20735201TVI	1.409,00	89
20625291NM	1.100,00	233	20635299	525,00	231	20725191	666,00	188	20725309	1.568,00	209	20735201TVI	1.409,00	89
20625291OM	1.333,00	233	20635299AC	867,00	231	20725191AC	1.100,00	188	20725309AC	2.587,00	209	20735202	1.084,00	89
20625291OR	1.333,00	233	20635299BM	867,00	231	20725191BM	1.100,00	188	20725309BM	2.587,00	209	20735202	1.084,00	89
20625299	536,00	230	20635299NM	867,00	231	20725191NM	1.100,00	188	20725309NM	2.587,00	209	20735202AC	1.788,00	89
20625299AC	884,00	230	20635299OM	1.051,00	231	20725191OM	1.333,00	188	20725311	1.729,00	210	20735202AC	1.788,00	106
20625299BM	884,00	230	20635299OR	1.051,00	231	20725191OR	1.333,00	188	20725311AC	2.854,00	210	20735202AC	1.788,00	106
20625299NM	884,00	230	20635301	1.261,00	241	20725192	796,00	188	20725311BM	2.854,00	210	20735202AM	1.788,00	106
20625299OM	1.071,00	230	20635301AC	2.081,00	241	20725199	536,00	186	20725311NM	2.854,00	210	20735202AM	1.788,00	106
20625299OR	1.071,00	230	20635301BM	2.081,00	241	20725199AC	884,00	186	207253112	1.737,00	211	20735202BL	1.788,00	106
20625301	1.268,00	240	20635301NM	2.081,00	241	20725199BM	884,00	186	20725313	1.832,00	211	20735202BL	1.788,00	106
20625301AC	2.093,00	240	20635302	1.474,00	242	20725199NM	884,00	186	20725391	859,00	206	20735202BM	1.788,00	89
20625301BM	2.093,00	240	20635302AC	2.433,00	242	20725199OM	1.071,00	186	20725391AC	1.418,00	206	20735202BM	1.788,00	106
20625301NM	2.093,00	240	20635302BM	2.433,00	242	20725199OR	1.071,00	186	20725391BM	1.418,00	206	20735202BM	1.788,00	106
20625302	1.504,00	240	20635302NM	2.433,00	242	20725201	890,00	192	20725391NM	1.418,00	206	20735202FU	1.788,00	106
20625391	859,00	239	20635391	849,00	239	20725201AC	1.469,00	192	20725391OM	1.718,00	206	20735202FU	1.788,00	106
20625391AC	1.418,00	239	20635391AC	1.401,00	239	20725201BM	1.469,00	192	20725391OR	1.718,00	206	20735202NA	1.788,00	106
20625391BM	1.418,00	239	20635391BM	1.401,00	239	20725201NM	1.469,00	192	20725392	965,00	206	20735202NA	1.788,00	106
20625391NM	1.418,00	239	20635391NM	1.401,00	239	20725201OR	1.780,00	192	20725399	706,00	186	20735202NE	1.788,00	106
20625391OM	1.718,00	239	20635391OM	1.697,00	239	20725201OR	1.780,00	192	20725399AC	1.165,00	186	20735202NE	1.788,00	106
20625391OR	1.718,00	239	20635391OR	1.697,00	239	20725202	1.015,00	54	20725399BM	1.165,00	186	20735202NM	1.788,00	89
20625399	706,00	231	20635399	695,00	231	20725202	1.015,00	193	20725399NM	1.165,00	186	20735202NM	1.788,00	106
20625399AC	1.165,00	231	20635399AC	1.147,00	231	20725202AC	1.675,00	54	20725399OM	1.411,00	186	20735202NM	1.788,00	106
20625399BM	1.165,00	231	20635399BM	1.147,00	231	20725202AC	1.675,00	69	20725399OR	1.411,00	186	20735202OM	2.167,00	89
20625399NM	1.165,00	231	20635399NM	1.147,00	231	20725202AC	1.675,00	193	20725401	1.997,00	224	20735202OM	2.167,00	106
20625399OM	1.411,00	231	20635399OM	1.391,00	231	20725202BL	1.675,00	54	20725402	2.093,00	225	20735202OM	2.167,00	106
20625399OR	1.411,00	231	20635399OR	1.391,00	231	20725202BL	1.675,00	69	20725403	2.219,00	225	20735202OP	2.167,00	89
20625491	859,00	243	20635491	849,00	243	20725202BL	1.675,00	193	20725404	2.691,00	226	20735202OP	2.167,00	106
20625491AC	1.418,00	243	20635491AC	1.401,00	243	20725202BM	1.675,00	54	20725491	859,00	222	20735202OR	2.167,00	89
20625491BM	1.418,00	243	20635491BM	1.401,00	243	20725202BM	1.675,00	69	20725491AC	1.418,00	222	20735202OR	2.167,00	106
20625491NM	1.418,00	243	20635491NM	1.401,00	243	20725202BM	1.675,00	193	20725491BM	1.418,00	222	20735202OR	2.167,00	106
20625491OM	1.718,00	243	20635491OM	1.697,00	243	20725202NE	1.675,00	54	20725491NM	1.418,00	222	20735202RO	1.788,00	106
20625491OR	1.718,00	243	20635491OR	1.697,00	243	20725202NE	1.675,00	69	20725491NM	1.718,00	222	20735202RO	1.788,00	106
20625499	706,00	231	20635499	695,00	231	20725202NE	1.675,00	193	20725491OR	1.718,00	222	20735202VE	1.788,00	106
20625499AC	1.165,00	231	20635499AC	1.147,00	231	20725202NM	1.675,00	54	20725499	965,00	222	20735202VE	1.788,00	106
20625499BM	1.165,00	231	20635499BM	1.147,00	231	20725202NM	1.675,00	69	20725499	706,00	187	20735202VE	1.788,00	106
20625499NM	1.165,00	231	20635499NM	1.147,00	231	20725202OM	1.675,00	193	20725499AC	1.165,00	187	20735202VM	1.788,00	106
20625499OM	1.411,00	231	20635499OM	1.391,00	231	20725202OM	2.029,00	54	20725499BM	1.165,00	187	20735203	941,00	200
20625499OR	1.411,00	231	20635499OR	1.391,00	231	20725202OM	2.029,00	69	20725499NM	1.165,00	187	20735204	1.257,00	201
20635191	679,00	232	20718107	241,00	592	20725202OM	2.029,00	193	20725499NM	1.411,00	187	20735204AC	2.073,00	201
20635191AC	1.121,00	232	20718107AC	398,00	167	20725202OR	2.029,00	54	20725499OR	1.411,00	187	20735204BM	2.073,00	201
20635191BM	1.121,00	232	20718107BM	398,00	167	20725202OR	2.029,00	69	20735191	679,00	189	20735204NM</		

Ref./Nr./Kód	Price	Page	Ref./Nr./Kód	Price	Page	Ref./Nr./Kód	Price	Page	Ref./Nr./Kód	Price	Page	Ref./Nr./Kód	Price	Page
20735212	1.507,00	202	21027301OR	2.163,00	297	21112002BM	138,00	116	21120301OM	361,00	111	21128007BM	473,00	121
20735213	751,00	198	21027302	1.345,00	297	21112002D	98,30	116	21120301OP	361,00	111	21128007BM	473,00	121
20735291	679,00	191	21027303	1.704,00	298	21112002KM	138,00	116	21120301OR	361,00	111	21128007KMB	473,00	121
20735291AC	1.121,00	191	21027303AC	2.812,00	298	21112002KMB	138,00	116	21120302	180,00	110	21128007NM	473,00	121
20735291BM	1.121,00	191	21027303BM	2.812,00	298	21112002NM	138,00	116	21120302AC	298,00	110	21128007OM	573,00	121
20735291NM	1.121,00	191	21027303NM	2.812,00	298	21112002OP	167,00	116	21120302BM	298,00	110	21128007OP	573,00	121
20735291OM	1.358,00	191	21027303OM	3.407,00	298	21112002OP	167,00	116	21120302KM	298,00	110	21128007OR	573,00	121
20735291OR	1.358,00	191	21027303OR	3.407,00	298	21112002OR	167,00	116	21120302KMB	298,00	110	21128030	435,00	119
20735292	785,00	191	21027304	902,00	298	21115101	247,00	115	21120302NM	298,00	110	21128030AC	717,00	119
20735299	525,00	187	21027305	1.019,00	299	21115101AC	408,00	115	21120302OP	361,00	110	21128030BM	717,00	119
20735299AC	867,00	187	21027306	1.713,00	301	21115101BM	408,00	115	21120302OR	361,00	110	21128030KMB	717,00	119
20735299BM	867,00	187	21027307	1.676,00	301	21115101KM	408,00	115	21120302OR	361,00	110	21128030NM	717,00	119
20735299NM	867,00	187	21027308	1.905,00	300	21115101KMB	408,00	115	21120501	135,00	112	21128030NM	717,00	119
20735299OR	1.051,00	187	21027309	1.262,00	300	21115101NM	408,00	115	21120501AC	224,00	112	21128030OM	869,00	119
20735299OR	1.051,00	187	21027310	1.090,00	302	21115101OM	494,00	115	21120501BM	224,00	112	21128030OP	869,00	119
20735301	1.705,00	214	21027311	1.127,00	302	21115101OP	494,00	115	21120501KM	224,00	112	21128030OR	869,00	119
20735302	1.523,00	215	21027311AC	1.860,00	302	21115101OR	494,00	115	21120501KMB	224,00	112	21128040	464,00	118
20735302AC	2.514,00	215	21027311BM	1.860,00	302	21115201	268,00	115	21120501NM	224,00	112	21128040AC	765,00	118
20735302BM	2.514,00	215	21027311NM	1.860,00	302	21115201AC	442,00	115	21120501OM	270,00	112	21128040BM	765,00	118
20735302NM	2.514,00	215	21027312	790,00	303	21115201BM	442,00	115	21120501OP	270,00	112	21128040KMB	765,00	118
20735303	1.624,00	217	21027313	713,00	303	21115201KM	442,00	115	21120501OR	270,00	112	21128040NM	765,00	118
20735304	2.469,00	218	21027313AC	1.176,00	303	21115201KMB	442,00	115	21122401	164,00	117	21128040NM	765,00	118
20735305	1.570,00	218	21027313BM	1.176,00	303	21115201NM	442,00	115	21122401AC	271,00	117	21128040OM	927,00	118
20735306	1.748,00	221	21027313NM	1.176,00	303	21115201OP	536,00	115	21122401BM	271,00	117	21128040OP	927,00	118
20735307	2.334,00	220	21027391	424,00	296	21115201OP	536,00	115	21122401KM	271,00	117	21128040OR	927,00	118
20735308	1.334,00	219	21027391AC	700,00	296	21115201OR	536,00	115	21122401KMB	271,00	117	21128050	539,00	120
20735308AC	2.201,00	219	21027391BM	700,00	296	21116101	299,00	122	21122401NM	328,00	117	21128050AC	889,00	120
20735309	1.619,00	215	21027391NM	700,00	296	21116101AC	493,00	122	21122401OP	328,00	117	21128050BM	889,00	120
20735309AC	2.672,00	215	21027391OM	849,00	296	21116101BM	493,00	122	21122401OP	328,00	117	21128050KMB	889,00	120
20735309BM	2.672,00	215	21027391OR	849,00	296	21116101KM	493,00	122	21122401OR	328,00	117	21128050NM	889,00	120
20735309NM	2.672,00	215	21027399	318,00	296	21116101KMB	493,00	122	21127701	64,90	118	21128050NM	889,00	120
20735310	1.895,00	216	21027399AC	525,00	296	21116101NM	493,00	122	21127701AC	104,00	118	21128050OM	1.077,00	120
20735311	1.990,00	217	21027399BM	525,00	296	21116101OM	597,00	122	21127701BM	104,00	118	21128050OP	1.077,00	120
20735312	2.583,00	216	21027399NM	525,00	296	21116101OP	597,00	122	21127701KMB	104,00	118	21128050OR	1.077,00	120
20735391	849,00	207	21027399OM	637,00	296	21116101OR	597,00	122	21127701NM	104,00	118	21128060	849,00	120
20735391AC	1.401,00	207	21027399OR	637,00	296	21116103	288,00	122	21127701NM	104,00	118	21128060AC	1.400,00	120
20735391BM	1.401,00	207	21110301	83,35	111	21116103AC	476,00	122	21127701OM	130,00	118	21128060BM	1.400,00	120
20735391NM	1.401,00	207	21110301AC	138,00	111	21116103BM	476,00	122	21127701OP	130,00	118	21128060KMB	1.400,00	120
20735391OM	1.697,00	207	21110301BM	138,00	111	21116103KMB	476,00	122	21127701OR	130,00	118	21128060NM	1.400,00	120
20735391OR	1.697,00	207	21110301D	98,30	111	21116103KMB	476,00	122	21128001	109,00	118	21128060NM	1.400,00	120
20735392	955,00	207	21110301KM	138,00	111	21116103NM	476,00	122	21128001AC	175,00	118	21128060OP	1.697,00	120
20735399	695,00	187	21110301KMB	138,00	111	21116103OP	577,00	122	21128001BM	175,00	118	21128060OR	1.697,00	120
20735399AC	1.147,00	187	21110301NM	138,00	111	21116103OP	577,00	122	21128001KMB	175,00	118	21128060OR	1.697,00	120
20735399BM	1.147,00	187	21110301OP	167,00	111	21116103OR	577,00	122	21128001NM	175,00	118	21128070	286,00	121
20735399NM	1.147,00	187	21110301OP	167,00	111	21116409	225,00	122	21128001NM	175,00	118	21128070AC	473,00	121
20735399OM	1.391,00	187	21110301OR	167,00	111	21116409AC	371,00	122	21128001OP	218,00	118	21128070BM	473,00	121
20735399OR	1.391,00	187	21110302	83,35	110	21116409BM	371,00	122	21128001OP	218,00	118	21128070KMB	473,00	121
20735401	1.989,00	227	21110302AC	138,00	110	21116409KM	371,00	122	21128001OR	218,00	118	21128070NM	473,00	121
20735402	2.090,00	229	21110302BM	138,00	110	21116409KMB	371,00	122	21128003	435,00	119	21128070NM	473,00	121
20735403	2.210,00	227	21110302D	98,30	110	21116409NM	371,00	122	21128003AC	717,00	119	21128070OM	573,00	121
20735404	2.682,00	228	21110302KM	138,00	110	21116409OM	449,00	122	21128003BM	717,00	119	21128070OP	573,00	121
20735491	849,00	223	21110302KMB	138,00	110	21116409OP	449,00	122	21128003KMB	717,00	119	21128070OR	573,00	121
20735491AC	1.401,00	223	21110302NM	138,00	110	21116409OR	449,00	122	21128003NM	717,00	119	21130001	175,00	115
20735491BM	1.401,00	223	21110302OP	167,00	110	21116701	170,00	117	21128003OM	717,00	119	21130001AC	306,00	115
20735491NM	1.401,00	223	21110302OP	167,00	110	21116701AC	281,00	117	21128003OM	869,00	119	21130001BM	306,00	115
20735491OM	1.697,00	223	21110302OR	167,00	110	21116701BM	281,00	117	21128003OP	869,00	119	21130001KMB	306,00	115
20735491OR	1.697,00	223	21110501	180,00	113	21116701KM	281,00	117	21128003OR	869,00	119	21130001NM	306,00	115
20735492	955,00	223	21110501AC	298,00	113	21116701KMB	281,00	117	21128004	464,00	118	21130001NM	306,00	115
20735499	695,00	187	21110501BM	298,00	113	21116701NM	281,00	117	21128004AC	765,00	118	21130001OM	350,00	115
20735499AC	1.147,00	187	21110501KM	298,00	113	21116701OP	340,00	117	21128004BM	765,00	118	21130001OP	350,00	115
20735499BM	1.147,00	187	21110501KMB	298,00	113	21116701OP	340,00	117	21128004KMB	765,00	118	21130001OR	350,00	115
20735499NM	1.147,00	187	21110501NM	298,00	113	21116701OR	340,00	117	21128004NM	765,00	118	21130002	185,00	115
20735499OM	1.391,00	187	21110501OM	361,00	113	21117001	191,00	117	21128004NM	765,00	118	21130002AC	322,00	115
20735499OR	1.391,00	187	21110501OP	361,00	113	21117001AC	315,00	117	21128004OP	927,00	118	21130002BM	322,00	115
20739201	941,00	203	21110501OR	361,00	113	21117001BM	315,00	117	21128004OP	927,00	118	21130002KMB	322,00	115
20739201AC	1.554,00	203	21110502	185,00	114	21117001KM	315,00	117	21128004OR	927,00	118	21130002NM	322,00	115
20739201BM	1.554,00	203	21110502AC	306,00	114	21117001KMB	315,00	117	21128005	539,00	119	21130002NM	322,00	115
20739201NM	1.554,00	203	21110502BM	306,00	114	21117001NM	315,00	117	21128005AC	889,00	119	21130002OM	391,00	115
20739201OM	1.883,00	203	21110502KM	306,00	114	21117001OM	381,00	117	21128005BM	889,00	119	21130002OP	391,00	115
20739201OR	1.883,00	203	21110502KMB	306,00	114	21117001OP	381,00	117	21128005KMB	889,00	119	21130002OR	391,00	115
			21110502NM	306,00	114	21117001OR	381,00	117	21128005NM	889,00	119	21130011	205,0	

LIST OF PRODUCT REFERENCES / LISTA DI CODICI ARTICOLI / SEZNAM REFERENC

Ref./Nr./Kód	Price	Page	Ref./Nr./Kód	Price	Page	Ref./Nr./Kód	Price	Page	Ref./Nr./Kód	Price	Page	Ref./Nr./Kód	Price	Page
2113001ZOP	451,00	115	21190401	170,00	111	24214501LM	489,00	140	24217701	81,40	137	24230601	82,40	131
2113001ZOR	451,00	115	21190401AC	281,00	111	24214501LV	489,00	140	24217701AC	135,00	137	24230601AC	136,00	131
21130501	151,00	112	21190401BM	281,00	111	24214501OR	698,00	140	24217701LM	114,00	137	24230601LM	115,00	131
21130501AC	250,00	112	21190401KM	281,00	111	24214601	443,00	139	24217701LV	114,00	137	24230601LV	115,00	131
21130501BM	250,00	112	21190401KMB	281,00	111	24214601AC	731,00	139	24217701OR	163,00	137	24230601OR	165,00	131
21130501KM	250,00	112	21190401NM	281,00	111	24214601LM	620,00	139	24217703	374,00	138	24231001	179,00	181
21130501KMB	250,00	112	21190401OM	340,00	111	24214601LV	620,00	139	24217703AC	617,00	138	24231001AC	297,00	181
21130501NM	250,00	112	21190401OP	340,00	111	24214601OR	886,00	139	24217703LM	524,00	138	24231001LM	251,00	181
21130501OM	303,00	112	21190401OR	340,00	111	24214602	443,00	140	24217703LV	524,00	138	24231001LV	251,00	181
21130501OP	303,00	112	21190501	176,00	112	24214602AC	731,00	140	24218001	130,00	137	24231001OR	358,00	181
21130501OR	303,00	112	21190501AC	292,00	112	24214602LM	620,00	140	24218001AC	214,00	137	24233401	310,00	179
21131201	738,00	124	21190501BM	292,00	112	24214602LV	620,00	140	24218001LM	182,00	137	24233401AC	512,00	179
21131202	738,00	346	21190501KM	292,00	112	24214602OR	886,00	140	24218001LV	182,00	137	24233401LM	435,00	179
21139501	695,00	123	21190501KMB	292,00	112	24215101	210,00	130	24218001OR	260,00	137	24233401LV	435,00	179
21139502	695,00	340	21190501NM	292,00	112	24215101AC	347,00	130	24218003	488,00	137	24233401OR	620,00	179
21139501AC	1.147,00	123	21190501OM	352,00	112	24215101LM	295,00	130	24218003AC	807,00	137	24234101	244,00	175
21139501AD	1.147,00	340	21190501OP	352,00	112	24215101LV	295,00	130	24218003LM	684,00	137	24234101AC	404,00	175
21139501BM	1.147,00	123	21190501OR	352,00	112	24215101OR	420,00	130	24218003LV	684,00	137	24234101LM	342,00	175
21139501BM	1.147,00	340	21190601	181,00	112	24215102	236,00	131	24218003OR	976,00	137	24234101LV	342,00	175
21139501NM	1.147,00	123	21190601AC	300,00	112	24215102AC	389,00	131	24218004	451,00	138	24234101OR	488,00	175
21139501NM	1.147,00	340	21190601BM	300,00	112	24215102LM	331,00	131	24218004AC	745,00	138	24234201	176,00	181
21139502	663,00	123	21190601KM	300,00	112	24215102LV	331,00	131	24218004LM	632,00	138	24234201AC	292,00	181
21139502	663,00	341	21190601KMB	300,00	112	24215102OR	472,00	131	24218004LV	632,00	138	24234201LM	247,00	181
21140501	178,00	113	21190601NM	300,00	112	24215501	70,05	149	24218004OR	902,00	138	24234201LV	247,00	181
21140501AC	295,00	113	21190601OM	363,00	112	24215501AC	116,00	149	24218005	282,00	138	24234201OR	352,00	181
21140501BM	295,00	113	21190601OP	363,00	112	24215501LM	98,10	149	24218005AC	467,00	138	24235201	657,00	144
21140501KM	295,00	113	21190601OR	363,00	112	24215501LV	98,10	149	24218005LM	396,00	138	24235201AC	1.085,00	144
21140501KMB	295,00	113				24215501OR	140,00	149	24218005LV	396,00	138	24235201LM	921,00	144
21140501NM	295,00	113	24			24215502	70,05	149	24218005OR	564,00	138	24235201LV	921,00	144
21140501OM	356,00	113	24210201	204,00	129	24215502AC	116,00	149	24218006	487,00	139	24235201OR	1.314,00	144
21140501OP	356,00	113	24210201AC	337,00	129	24215502LM	98,10	149	24218006AC	804,00	139	24235202	863,00	144
21140501OR	356,00	113	24210201BM	286,00	129	24215502LV	98,10	149	24218006LM	683,00	139	24235202AC	1.425,00	144
21150301	93,75	113	24210201LV	286,00	129	24215502OR	140,00	149	24218006LV	683,00	139	24235202LM	1.209,00	144
21150301AC	156,00	113	24210201OR	408,00	129	24216301	216,00	134	24218201	52,55	136	24235202LV	1.209,00	144
21150301BM	156,00	113	24210301	162,00	128	24216301AC	357,00	134	24218201AC	86,70	136	24235202OR	1.726,00	144
21150301KM	156,00	113	24210301AC	268,00	128	24216301LM	303,00	134	24218201LM	73,55	136	24235203	792,00	145
21150301KMB	156,00	113	24210301BM	227,00	128	24216301LV	303,00	134	24218201LV	73,55	136	24235203AC	1.307,00	145
21150301NM	156,00	113	24210301LM	227,00	128	24216301OR	433,00	134	24218201OR	105,00	136	24235203LM	1.109,00	145
21150301OM	188,00	113	24210301LV	227,00	128	24216402	536,00	142	24219101	884,00	134	24235203LV	1.109,00	145
21150301OP	188,00	113	24210301OR	323,00	128	24216402AC	884,00	142	24219101AC	1.459,00	134	24235301	1.085,00	145
21150301OR	188,00	113	24210501	295,00	129	24216402LM	750,00	142	24219101LM	1.238,00	134	24235301AC	1.790,00	145
21175101	247,00	115	24210501AC	486,00	129	24216402LV	750,00	142	24219101LV	1.238,00	134	24235301LM	1.519,00	145
21175101AC	408,00	115	24210501BM	413,00	129	24216409	379,00	141	24219401	349,00	140	24235301LV	1.519,00	145
21175101BM	408,00	115	24210501LV	413,00	129	24216409AC	626,00	141	24219401AC	577,00	140	24235301OR	2.169,00	145
21175101KM	408,00	115	24210501OR	589,00	129	24216409LM	532,00	141	24219401LM	489,00	140	24244101	185,00	175
21175101KMB	408,00	115	24210601	241,00	129	24216409LV	532,00	141	24219401LV	489,00	140	24244101AC	306,00	175
21175101NM	408,00	115	24210601AC	399,00	129	24216409OR	758,00	141	24219401OR	698,00	140	24244101LM	260,00	175
21175101OM	494,00	115	24210601BM	338,00	129	24216701	220,00	133	24219402	498,00	140	24244101LV	260,00	175
21175101OP	494,00	115	24210601LV	338,00	129	24216701AC	374,00	133	24219402AC	821,00	140	24244101OR	371,00	175
21175101OR	494,00	115	24210601OR	482,00	129	24216701LM	313,00	133	24219402LM	697,00	140	24247601	334,00	136
21175201	268,00	116	24210801	191,00	128	24216701LV	313,00	133	24219402LV	697,00	140	24247601AC	551,00	136
21175201AC	442,00	116	24210801AC	267,00	128	24216701OR	447,00	133	24219403	279,00	142	24247601LM	468,00	136
21175201BM	442,00	116	24210801BM	267,00	128	24217001	262,00	133	24219403AC	729,00	167	24247601LV	468,00	136
21175201KM	442,00	116	24210801LV	267,00	128	24217001AC	433,00	133	24219403LM	461,00	142	24247602	334,00	135
21175201KMB	442,00	116	24210801OR	381,00	128	24217001LM	367,00	133	24219403LV	461,00	167	24247602AC	551,00	135
21175201NM	442,00	116	24210901	132,00	128	24217001OR	367,00	133	24219403OR	391,00	142	24247602LM	468,00	135
21175201OM	536,00	116	24210901AC	218,00	128	24217001LV	523,00	133	24219403LM	391,00	167	24247602LV	468,00	135
21175201OP	536,00	116	24210901BM	185,00	128	24217301	87,55	130	24219403LV	391,00	142	24250001	64,90	149
21175201OR	536,00	116	24210901LV	185,00	128	24217301AC	145,00	130	24219501	663,00	143	24250001AC	107,00	149
21175301	278,00	116	24210901OR	264,00	128	24217301LM	123,00	130	24219501AC	1.095,00	143	24250001LM	90,85	149
21175301AC	459,00	116	24210902	205,00	129	24217301LV	123,00	130	24219501LM	929,00	143	24250001LV	90,85	149
21175301BM	459,00	116	24210902AC	339,00	129	24217301OR	175,00	130	24219501LV	929,00	143	24250001OR	130,00	149
21175301KM	459,00	116	24210902LM	287,00	129	24217302	77,25	130	24219502	929,00	143	24250301	77,25	131
21175301KMB	459,00	116	24210902LV	287,00	129	24217302AC	128,00	130	24219502AC	764,00	143	24250301AC	128,00	131
21175301NM	459,00	116	24210902OR	410,00	129	24217302LM	108,00	130	24219502LM	1.262,00	143	24250301LM	108,00	131
21175301OM	556,00	116	24212001	167,00	132	24217302LV	108,00	130	24219502LV	1.070,00	143	24250301LV	108,00	131
21175301OP	556,00	116	24212001AC	276,00	132	24217302OR	155,00	130	24219502LV	1.070,00	143	24250301OR	155,00	131
21175301OR	556,00	116	24212001BM	234,00	132	24217409	424,00	141	24219801	708,00	143	24252001	76,25	131
21180301	200,00	111	24212001LV	234,00	132	24217409AC	700,00	141	24219801AC	1.168,00	143	24252001AC	127,00	131
21180301AC	331,00	111	24212001OR	334,00	132	24217409LM	594,00	141	24219801LM	991,00	143	24252001LM	107,00	131
21180301BM	331,00	111	24212101	210,00	133	24217409LV	594,00	141	24219801LV	991,00	143	24252001LV	107,00	131
21180301KM	331,00	111	24212101AC	347,00	133	24217409OR	849,00	141	24220001	201,00	130	242520		

Ref./Nr./Kod	Price	Page	Ref./Nr./Kod	Price	Page	Ref./Nr./Kod	Price	Page	Ref./Nr./Kod	Price	Page	Ref./Nr./Kod	Price	Page
24284001KM	62,60	164	26117001KM	397,00	81	26218004OP	196,00	167	26228040KMB	794,00	82	26230801TNA	423,00	74
24284001KMB	62,60	164	26117001KMB	397,00	81	26218004OR	196,00	167	26228040NM	794,00	82	26230801TNE	423,00	74
24284001LM	53,10	164	26117001NM	397,00	81	26222402C	164,00	79	26228040QM	962,00	82	26230801TRO	423,00	74
24284001LV	53,10	164	26117001OM	480,80	81	26222402AC	271,00	79	26228040QP	962,00	82	26230801TVI	423,00	74
24284001NA	62,60	164	26117001OP	480,80	81	26222402BM	271,00	79	26228040QR	962,00	82	26230801TVE	423,00	74
24284001NE	62,60	164	26117001OR	480,80	81	26222402KM	271,00	79	26228050	915,80	84	26231201	802,00	88
24284001NM	62,60	164	26117001TAM	397,00	81	26222402KMB	271,00	79	26228050AC	1.509,80	84	26231201	802,00	348
24284001OM	75,85	164	26117001TB	397,00	81	26222402NM	271,00	79	26228050BM	1.509,80	84	26238701	670,00	88
24284001OP	75,85	164	26117001TFU	397,00	81	26222402OM	328,00	79	26228050KM	1.509,80	84	26238701AC	1.105,00	88
24284001OR	75,85	164	26117001TNA	397,00	81	26222402OP	328,00	79	26228050KMB	1.509,80	84	26238701BM	1.105,00	88
24284001RO	62,60	164	26117001TNE	397,00	81	26222402OR	328,00	79	26228050NM	1.509,80	84	26238701NM	1.105,00	88
24284001VE	62,60	164	26117001TRO	397,00	81	26222402TAM	271,00	79	26228050OM	1.829,80	84	26247001	979,00	86
24284001VI	62,60	164	26117001TVE	397,00	81	26222402TBL	271,00	79	26228050OP	1.829,80	84	26247001AC	1.615,00	86
24284002	35,30	164	26117001TVI	397,00	81	26222402TFU	271,00	79	26228050OR	1.829,80	84	26247001BM	1.615,00	86
24284002AC	58,25	164	26117209	335,00	87	26222402TNA	271,00	79	26228060	322,00	84	26247001NM	1.615,00	86
24284002AL	58,25	164	26117209AC	553,00	87	26222402TNE	271,00	79	26228060AC	532,00	84	26247001OM	1.957,00	86
24284002BM	58,25	164	26117209BM	553,00	87	26222402TRO	271,00	79	26228060AB	532,00	84	26247001OP	1.957,00	86
24284002CM	58,25	164	26117209CM	553,00	87	26222402TVE	271,00	79	26228060AM	532,00	84	26247001OR	1.957,00	86
24284002DL	49,40	164	26117209KMB	553,00	87	26222402TVI	271,00	79	26228060KMB	532,00	84	26247002	979,00	86
24284002EL	49,40	164	26117209NM	553,00	87	26222701	99,90	81	26228060NM	532,00	84	26247002AC	1.615,00	86
24284002FE	58,25	164	26117209OM	670,00	87	26227701AC	160,00	81	26228060OM	645,80	84	26247002BM	1.615,00	86
24284002GE	58,25	164	26117209OP	670,00	87	26227701BM	160,00	81	26228060OP	645,80	84	26247002NM	1.615,00	86
24284002HM	70,60	164	26117209OR	670,00	87	26227701KM	160,00	81	26228060OR	645,80	84	26247002OM	1.957,00	86
24284002IR	70,60	164	26121001	721,00	88	26227701KMB	160,00	81	26230001	207,00	78	26247002OP	1.957,00	86
24287101	120,00	142	26121001	721,00	344	26227701NM	160,00	81	26230001AC	342,00	78	26247002OR	1.957,00	86
24287101	120,00	167	26130701	232,00	72	26227701OM	200,00	81	26230001BM	342,00	78	26285301	567,00	77
24287101AC	198,00	142	26130701AC	383,00	72	26227701OP	200,00	81	26230001KM	342,00	78	26285301AC	935,00	77
24287101AL	198,00	167	26130701BM	383,00	72	26227701OR	200,00	81	26230001KMB	342,00	78	26285301BM	935,00	77
24287101AM	168,00	142	26130701KM	383,00	72	26228001	176,00	81	26230001NM	342,00	78	26285301NM	935,00	77
24287101AN	168,00	167	26130701KMB	383,00	72	26228001AC	282,00	81	26230001OM	414,00	78	26285301OM	1.133,00	77
24287101AV	168,00	142	26130701NM	383,00	72	26228001BM	282,00	81	26230001OP	414,00	78	26285301OP	1.133,00	77
24287101BV	168,00	167	26130701OR	464,00	72	26228001KM	282,00	81	26230001OR	414,00	78	26285301OR	1.133,00	77
24287101C	239,00	142	26130701OP	464,00	72	26228001KMB	282,00	81	26230002	217,00	78	26285302	567,00	77
24287101OR	239,00	167	26130701OR	464,00	72	26228001NM	282,00	81	26230002AC	358,00	78	26285302AC	935,00	77
24287101OT	239,00	167	26130701TAM	383,00	72	26228001OM	352,00	81	26230002BM	358,00	78	26285302BM	935,00	77
	26		26130701TB	383,00	72	26228001OP	352,00	81	26230002KMB	358,00	78	26285302NM	935,00	77
26110501	180,00	76	26130701TFU	383,00	72	26228001OR	352,00	81	26230002NM	358,00	78	26285302OM	1.133,00	77
26110501AC	298,00	76	26130701TNA	383,00	72	26228003	461,00	83	26230002NM	358,00	78	26285302OP	1.133,00	77
26110501AL	298,00	76	26130701TNE	383,00	72	26228003AC	761,00	83	26230002OM	435,00	78	26285302OR	1.133,00	77
26110501AM	298,00	76	26130701TRO	383,00	72	26228003BM	761,00	83	26230002OP	435,00	78	26290301	134,00	73
26110501B	298,00	76	26130701TVE	383,00	72	26228003KMB	761,00	83	26230002OR	435,00	78	26290301AC	221,00	73
26110501BM	298,00	76	26130701TVI	383,00	72	26228003KMB	761,00	83	26230011	242,00	78	26290301BM	221,00	73
26110501CM	361,00	76	26130801	257,00	73	26228003NM	761,00	83	26230011AC	399,00	78	26290301D	152,00	73
26110501D	361,00	76	26130801AC	423,00	73	26228003OM	923,00	83	26230011BM	399,00	78	26290301KM	221,00	73
26110501E	361,00	76	26130801AL	423,00	73	26228003OP	923,00	83	26230011KM	399,00	78	26290301KMB	221,00	73
26110501F	185,00	76	26130801AM	423,00	73	26228003OR	923,00	83	26230011KMB	399,00	78	26290301NM	221,00	73
26110501G	306,00	76	26130801OM	513,00	73	26228004	481,00	82	26230011NM	399,00	78	26290301OP	268,00	73
26110501H	306,00	76	26130801OP	513,00	73	26228004AC	794,00	82	26230011OM	484,00	78	26290301OR	268,00	73
26110501I	306,00	76	26130801OR	513,00	73	26228004AB	794,00	82	26230011OP	484,00	78	26290301OP	268,00	73
26110501J	306,00	76	26130801TB	423,00	73	26228004BM	794,00	82	26230011OR	484,00	78	26290301TAM	221,00	73
26110501K	306,00	76	26130801TBL	423,00	73	26228004KMB	794,00	82	26230012	252,00	78	26290301TBL	221,00	73
26110501L	371,00	76	26130801TFU	423,00	73	26228004NM	794,00	82	26230012AC	416,00	78	26290301TFU	221,00	73
26110501M	371,00	76	26130801TNA	423,00	73	26228004OM	962,00	82	26230012BM	416,00	78	26290301TNA	221,00	73
26110501N	371,00	76	26130801TNE	423,00	73	26228004OP	962,00	82	26230012KM	416,00	78	26290301TRO	221,00	73
26112001	132,00	79	26130801TRO	423,00	73	26228004OR	962,00	82	26230012KMB	416,00	78	26290301TVE	221,00	73
26112001D	149,00	79	26130801TVE	423,00	73	26228005	915,00	83	26230012NM	416,00	78	26290301TVI	221,00	73
26115001	432,00	85	26130801TVI	423,00	73	26228005AC	1.509,80	83	26230012OM	505,00	78	26290301TNE	221,00	73
26116209	274,00	87	26190301	134,00	72	26228005BM	1.509,80	83	26230012OP	505,00	78	26290401	181,00	75
26116209AC	452,00	87	26190301AC	221,00	72	26228005KM	1.509,80	83	26230012OR	505,00	78	26290401AC	300,00	75
26116209AL	452,00	87	26190301BM	221,00	72	26228005KMB	1.509,80	83	26230701	232,00	73	26290401BM	300,00	75
26116209AM	452,00	87	26190301D	152,00	72	26228005NM	1.509,80	83	26230701AC	380,00	73	26290401KM	300,00	75
26116209B	452,00	87	26190301KM	221,00	72	26228005OM	1.829,80	83	26230701BM	380,00	73	26290401KMB	300,00	75
26116209C	452,00	87	26190301KMB	221,00	72	26228005OP	1.829,80	83	26230701KM	380,00	73	26290401NM	300,00	75
26116209D	548,00	87	26190301NM	221,00	72	26228005OR	1.829,80	83	26230701KMB	380,00	73	26290401OP	363,00	75
26116209E	548,00	87	26190301OM	268,00	72	26228006	322,00	84	26230701NM	380,00	73	26290401OP	363,00	75
26116209F	548,00	87	26190301OP	268,00	72	26228006AC	532,00	84	26230701NM	464,00	73	26290401OR	363,00	75
26116701	211,00	80	26190301OR	268,00	72	26228006BM	532,00	84	26230701OP	464,00	73	26290401TAM	300,00	75
26116701AC	349,00	80	26190301TAM	221,00	72	26228006KM	532,00	84	26230701OR	464,00	73	26290401TBL	300,00	75
26116701AL	349,00	80	26190301TBL	221,00	72	26228006KMB	532,00	84	26230701TB	380,00	73	26290401TFU	300,00	75
26116701AM	349,00	80	26190301TFU	221,00	72	26228006NM	532,00	84	26230701TBL	380,00	73	26290401TNA	300,00	75
26116701AN	349,00	80	26190301TNA	221,00	72	26228006OM	645,80	84	26230701TFU	380,00	73	26290401TRO	300,00	75
26116701AO	349,00	80	26190301TNE	221,00	72	26228006OP	645,80	84	26230701TNA	380,00	73	26290401TVE	300,00	75
26116701AP	422,00	80	26190301TRO	221,00	72	26228006OR	645,80	84	26230701TNE	380,00	73	26290401TVI	300,00	75
261167														

LIST OF PRODUCT REFERENCES / LISTA DI CODICI ARTICOLI / SEZNAM REFERENC

Ref./Nr./Kód	Price	Page	Ref./Nr./Kód	Price	Page	Ref./Nr./Kód	Price	Page	Ref./Nr./Kód	Price	Page	Ref./Nr./Kód	Price	Page
26290402TNA	292,00	75	29963112OM	69,25	327	299955001	30,80	550	56243703	345,00	177	913478908	14,90	596
26290402TNE	292,00	75	29963112OP	69,25	327	299955001	664,00	308	56244003	250,00	175	9134828AC	16,05	574
26290402TRO	292,00	75	29963112OR	69,25	327	29995501AC	1.097,00	308				9134828AC	26,45	330
26290402TVE	292,00	75	29963113	36,40	328	29995501BM	1.097,00	308				9134828LM	26,45	330
26290402TVI	292,00	75	29963113AC	60,00	328	29995501NM	1.097,00	308	606486	529,00	170	9134828LM	26,45	330
26290403	170,00	74	29963113BM	60,00	328	29995501OM	1.329,00	308	6071649	561,00	68	9134828OR	32,05	330
26290403AC	281,00	74	29963113KM	60,00	328	29995501OR	1.329,00	308	607167	438,00	65	913483005I	75,35	573
26290403BM	281,00	74	29963113KM	60,00	328	29995502	889,00	308	60717009	499,00	65	913483005E	75,35	573
26290403KM	281,00	74	29963113NM	60,00	328	29995502AC	1.467,00	308	6071749	666,00	68	913483005S	75,35	573
26290403KMB	281,00	74	29963113OM	72,75	328	29995502BM	1.467,00	308	607395	1.314,00	69	913483006	17,70	573
26290403NM	281,00	74	29963113OP	72,75	328	29995502NM	1.467,00	308	607395	1.314,00	339	913484020	10,45	589
26290403OM	340,00	74	29963113OR	72,75	328	29995502OM	1.778,00	308	607934	297,00	558	9134841	6,75	576
26290403OP	340,00	74	29963203	350,00	315	29995502OR	1.778,00	308				9134848	6,75	576
26290403OR	340,00	74	29963203AC	578,00	315	2999550401	1.070,00	307				9134867	29,05	573
26290403TAM	281,00	74	29963203BM	578,00	315	2999550501	957,00	308	630497	413,00	171	9134872	30,80	595
26290403TBL	281,00	74	29963203NM	578,00	315	2999550501AC	1.579,00	308				9134880	22,55	568
26290403TFU	281,00	74	29963203OM	700,00	315	2999550501BM	1.579,00	308				9134881	28,50	574
26290403TNA	281,00	74	29963203OR	700,00	315	2999550501NM	1.579,00	308	910691403	126,00	352	9134887	14,30	574
26290403TNE	281,00	74	29963204	338,00	317	29995601	1.258,00	309	910691403AC	208,00	352	9134915	30,50	570
26290403TRO	281,00	74	29963204AC	558,00	317	29995701	1.661,00	309	910691403BM	208,00	352	916110348	31,25	587
26290403TVE	281,00	74	29963204BM	558,00	317	29995801	2.022,00	310	910691403NM	208,00	352	916119510	22,60	578
26290403TVI	281,00	74	29963204NM	558,00	317	29996201	1.378,00	307	9107515	115,00	569	9161515	11,00	569
			29963204OM	676,00	317	29996501	2.131,00	306	9120063690	12,40	154	916184606	24,45	587
			29963204OR	676,00	317	29996601	1.600,00	306	913412380	26,50	567	918119503	108,00	351
29911351	13,30	567	29963205	368,00	315	29996601AC	2.650,00	306	913412390	46,25	567	918138503	90,95	351
29933701	72,10	319	29963206	103,00	314	29996601BM	2.650,00	306	913414580	38,25	595	918138503AC	150,00	351
29933701AC	120,00	319	29963301	8,85	576	29996601NM	2.650,00	306	913419503	90,95	353	918138503BM	150,00	351
29933701LM	101,00	319	29963302	65,65	318	29997001	1.470,00	306	9134415	38,40	570	918138503NM	150,00	351
29933701LV	101,00	319	29963302AC	109,00	318	29997001AC	2.426,00	306	913446303	90,95	352	918192105	20,25	578
29933701OR	144,00	319	29963302BM	109,00	318	29997001BM	2.426,00	306	9134515	51,60	569	918271950	27,85	578
29933703	217,00	317	29963302NM	109,00	318	29997001NM	2.426,00	306	9134525	14,65	593	918763690	12,40	154
29933703AC	360,00	317	29963302OM	132,00	318	29997101	1.591,00	307	9134609	20,80	572			
29933703LM	305,00	317	29963302OR	132,00	318	29997201	1.994,00	306	913460910	18,75	572			
29933703LV	305,00	317	299633910	29,90	333				913460912	19,60	572			
29933703OR	435,00	317	299633910AC	49,30	333				913460912AC	32,30	330			
29943204	378,00	323	299633910LM	41,85	333	406486	529,00	170	913460912BM	32,30	330			
29951501	53,85	569	299633910LV	41,85	333	4071649	561,00	68	913460912KM	32,30	330			
29951502	47,90	570	299633910OR	59,75	333	407167	438,00	65	913460912KMB	32,30	330			
29951503	46,75	570	29963610	5,15	599	40717002	499,00	65	913460912NM	32,30	330			
29951504	517,00	329	29974802	25,20	568	4071749	666,00	68	913460912OM	39,15	330			
29951504AC	854,00	329	29974901	27,35	326	407395	1.314,00	69	913460912OP	39,15	330			
29951504BM	854,00	329	29974904	38,95	327	407395	1.314,00	339	913460912OR	39,15	330			
29951504NM	854,00	329	29974905	28,15	327	407934	297,00	558	913460915	20,15	572			
29951504OM	1.034,00	329	29974906	30,30	327				913460915AC	33,25	330			
29951504OR	1.034,00	329	29987001	97,70	373				913460915BM	33,25	330			
29951505	546,00	329	29987001	97,70	594				913460915KM	33,25	330			
29951505AC	901,00	329	29987002	110,00	373				913460915KMB	33,25	330			
29951505BM	901,00	329	29987002	110,00	594				913460915NM	33,25	330			
29951505NM	901,00	329	29990301	777,00	311	49286299	796,00	248	913460915OM	40,30	330			
29951505OM	1.092,00	329	29990301AC	1.282,00	311	49286398	849,00	248	913460915OP	40,30	330			
29951505OR	1.092,00	329	29990301BM	1.282,00	311	49286399	849,00	249	913460915OR	40,30	330			
29951506	313,00	329	29990301NM	1.282,00	311	49286499	902,00	249	913460920	21,20	573			
29951507	340,00	329	29990302	426,00	311	49288299	796,00	248	9134609AC	34,25	330			
29951607	777,00	309	29990302AC	705,00	311	49288398	849,00	248	9134609BM	34,25	330			
29951607AC	1.282,00	309	29990302BM	705,00	311	49288399	849,00	249	9134609KM	34,25	330			
29951607BM	1.282,00	309	29990302NM	705,00	311	49288499	902,00	249	9134609KMB	34,25	330			
29951607NM	1.282,00	309	29990302OM	853,00	311				9134609NM	34,25	330			
29951607OR	1.553,00	309	29990302OR	853,00	311				9134609OM	41,55	330			
29951607OR	1.553,00	309	29990303	383,00	311	50643703	522,00	177	9134609OP	41,55	330			
29952505	14,65	593	29990303AC	632,00	311	50644003	454,00	171	9134609OR	41,55	330			
29953202	302,00	320	29990303BM	632,00	311	50648603	529,00	170	9134615	25,20	571			
29953203	422,00	320	29990303NM	632,00	311	507164039	502,00	68	9134630	13,45	573			
29953204	399,00	321	29990303OM	766,00	311	50716703	438,00	65	913463250	15,85	590			
29953205	440,00	320	29990303OR	766,00	311	507170023	499,00	65	9134672	4,95	598			
29961001	3,90	599	29990304	367,00	313	507174039	590,00	68	9134672501	10,00	598			
29961002	5,05	599	29990304AC	606,00	313	50744003	454,00	171	9134673	5,15	598			
29961005	4,35	599	29990304BM	606,00	313	50783903	43,30	332	9134673501	10,00	598			
29961006	5,25	599	29990304NM	606,00	313				9134673503	10,00	598			
29963105	24,00	567	29990304OM	733,00	313				9134681	9,30	597			
29963108	17,35	567	29990304OR	733,00	313	5246360451	93,75	161	91346815	9,30	597			
29963109	44,30	136	29990306	470,00	312	5246360851	99,95	160	91346816	2,50	597			
29963109	44,30	328	29990306AC	776,00	312	5246360951	79,35	160	9134682	9,30	597			
29963109AC	73,10	136	29990306BM	776,00	312	5246361051	66,95	161	91346825	9,30	597			
29963109AC	73,10	328	29990306NM	776,00	312	5246361151	112,00	160	91346826	2,70	597			
29963109LM	62,05	136	29990306OM	939,00	312	5246361251	66,95	161	9134683	5,80	598			
29963109LM	62,05	328	29990306OR	939,00	312	5246361351	130,00	161	9134712	20,55	574			
29963109LV	62,05	136	29990307	514,00	312	5246361551	120,00	160	9134725	10,25	568			
29963109LV	62,05	328	29990307AC	849,00	312				9134731	29,15	574			
29963109OR	88,60	136	29990307BM	849,00	312				9134731051	75,35	574			
29963109OR	88,60	328	29990307NM	849,00	312	53049603	384,00	170	913474410	5,05	591			
29963112	34,65	327	29990307OM	1.028,00	312	53049703	413,00	171	913474420	5,05	591			
29963112AC	57,15	327	29990307OR	1.028,00	312	53049803	407,00	1						

Recommended installation

Installazione consigliata

Doporučená instalace

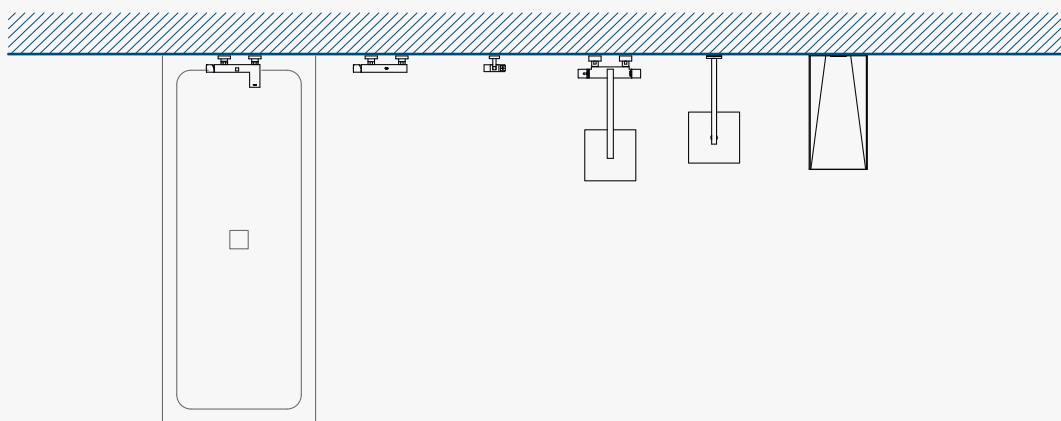
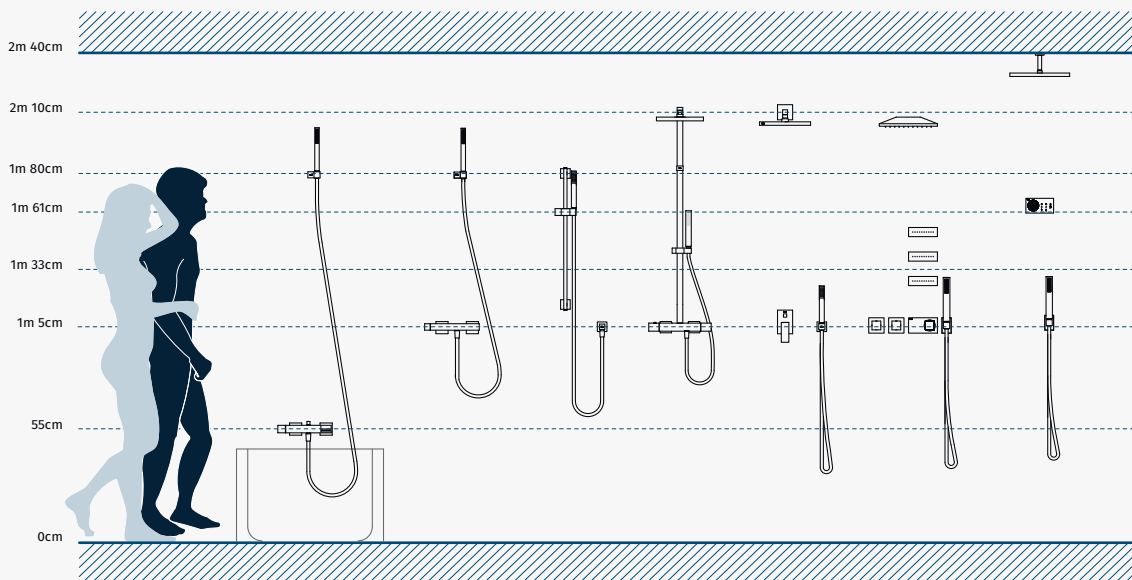

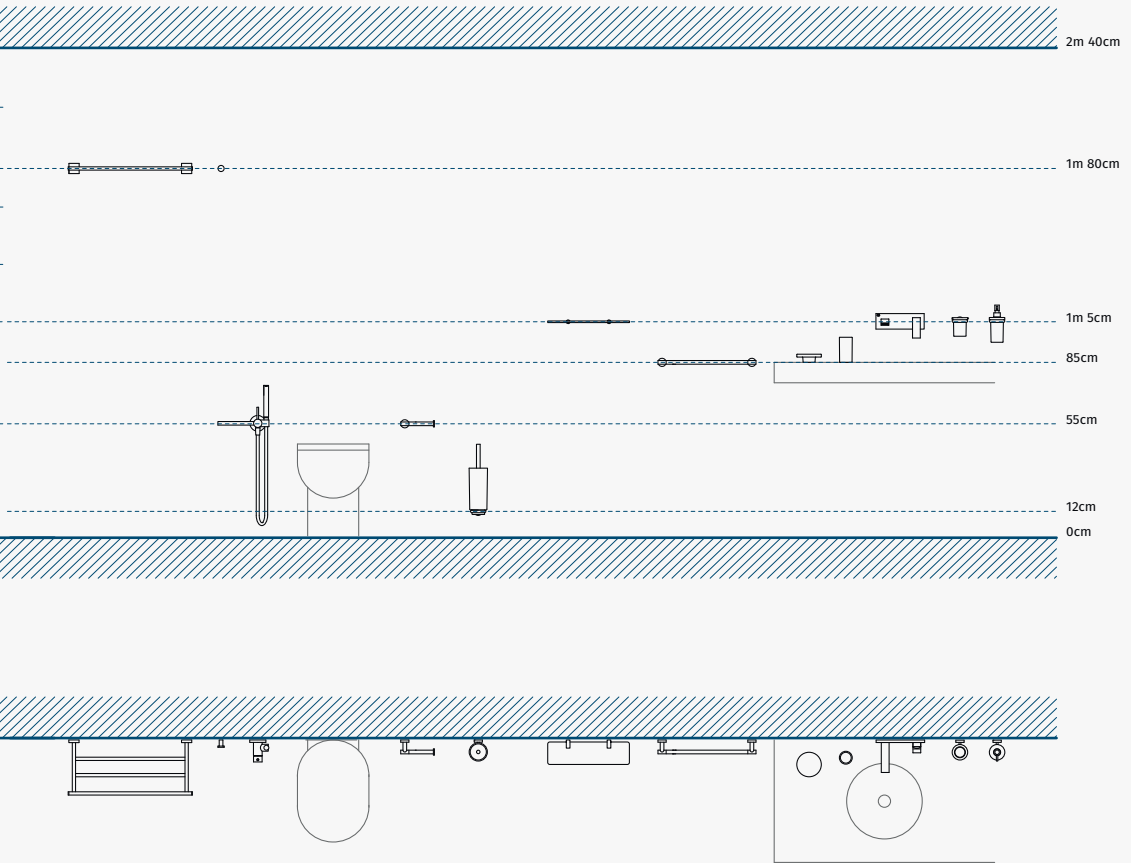

Shower drains

A shower may be equipped with two water outlets, as long as the drain has been designed to permit this (We recommend drain: Nr. 104840).

Scarichi doccia

Nella doccia sarà possibile utilizzare contemporaneamente due uscite dell'acqua, a condizione che lo scarico sia stato progettato allo scopo. (Si raccomanda l'uso dello scarico Ref: 104840).

Sprchové odtoky

Ve sprše bude možné použiť dva výstupy vody zároveň, avšak pokiaľ je k tomu odtok správne nadimenzovaný. (Doporučujeme odtok kód: 104840)



Water supply

Different products have different pressure and flow requirements, but a dynamic pressure of between 2 and 3 bar should be sufficient. Dynamic pressure is measured with the tap turned on.

Fornitura dell'acqua

Ogni prodotto richiede una pressione diversa a seconda del flusso, sebbene sia sufficiente una pressione dinamica compresa tra 2 e 3 bar. La pressione dinamica viene misurata con il rubinetto aperto.

Dodávka vody

Různé výrobky potřebují různý tlak s rozdílným průtokem, dynamický tlak mezi 2 až 3 bary však postačí. Tento dynamický tlak se měří s otevřeným kohoutkem.



Built-in taps

The great advantage of these built-in products is the extra space they provide in small showers. They are also much easier to clean.

Rubinerteria incassata

Questi prodotti incassati offrono l'enorme vantaggio di occupare meno spazio nelle docce piccole e di essere più facili da pulire.

Vestavěné baterie

Vestavěné baterie mají velkou výhodu v tom, že šetří prostor v malých sprchách a snadněji se čistí.

General terms of sale

Prices

Prices do not include VAT and goods will be at your service in our warehouse.

Prices from price list and any appendix that we publish, must be considered "recommended sale prices for end user before taxes".

Prices are subject to variations depending on market circumstances, raw material, labour force, taxes..., and the invoices will be issued based on prices valid on the shipment day.

Orders

Orders will be considered conditional and, therefore, subject to our consideration.

Design

Our models could be changed as a result of design requirements, with no prior notice, always to benefit the product

The photographic documentation and/or technical design reproduced on the lists, catalogues, leaflets and another publicity media have just an indicative value, then the customer can not resort to them in case of possible claims for disagreement or differences on supplied products. The claims about nonconformity of products supplied must be done, as maximum, 15 days after to receive the merchandise.

Delivery time

Our delivery time is always rough and we do not take responsibility for the troubles than the delay may cause.

Tres Comercial SA guarantee

TRES COMERCIAL SA guarantees its tapware against any structural, material or manufacturing defects for 5 years from the date of manufacture.

For special finishes (the entire range of colours, steel, copper old brass, matte chrome, gold, matte gold, wood and other special finishes), the guarantee is for 2 years for the surface finish and 5 years for mechanical components.

The electronic models (with the exception of our Shower Technology Blue Edition products), columns, thermostats and timers have a 2-year guarantee.

The complements and accessories (hoses, hand showers, nozzles, supports, valves, etc.) have a 2-year guarantee.

Consumable materials (filters, seals, aerators, etc.) are not covered by this guarantee unless manufacturing defects are demonstrated.

Services within the guarantee period

TRES COMERCIAL SA has the power to decide how to manage each case, depending on the type of product, either repairing it at TRES COMERCIAL SA facilities or replacing it with a new unit (installation costs not included).

Conditions and exclusions

Any failure to follow these instructions releases TRES Grifería from any liability.

These assembly, use and maintenance instructions are included in each product and are available at www.tresgriferia.com

Guarantee limitations

Any repair, replacement or provision of service for the affected product does not extend the Guarantee coverage.

For this guarantee to be valid, the defect in each case must be accepted by our technical department.

Our guarantee only covers the replacement of the material free of charge, and under no circumstances can we accept liability for any damages that the defect may have directly or indirectly caused, or the installation costs.

Jurisdiction

The good faith that always guides the relationships between TRES COMERCIAL SA and all its customers and our desire to resolve any differences amicably means that it is unthinkable for there to be any legal claims. However, in the unlikely case of such an event, both parties submit to the courts of Barcelona, expressly waiving any other jurisdiction.

TRES GRIFERÍA

C/ Penedès, 16-26 | Zona Industrial, Sector A
08759 Vallirana, (Barcelona) | Spain

Acceptance of conditions

All orders received imply the formal acceptance of these conditions unless others have been agreed in writing.

Payment

The invoices amount, unless special agreements must be paid by bank draft as maximum 30 days invoice date.

For upper payment terms will be charged financing.

In case that exist unpaid debt, we reserve the right to cancel the orders in process.

Right of ownership

TRES COMERCIAL SA reserve the right of ownership of all products supplied to the customer, up to receive the complete invoice payment.

VERY IMPORTANT

Return of goods

TRES COMERCIAL SA will not accept any return of goods without our agent has accepted it before and informed us.

- 1) TRES COMERCIAL SA does not accept any devolution without previous acceptance (the goods will be returned to the sender)
- 2) TRES COMERCIAL SA does not accept any return of good if it could be repair with original spare parts
- 3) TRES COMERCIAL SA does not accept any product devolution out of guarantee.
- 4) Nevertheless, in case of receiving any goods in perfect conditions, the merchandise undergoes the following depreciation on invoice:

- If it is from the same year: *-15% depreciation*
- If it is previous two years: *-30% depreciation*
- If it is previous three years: *-30% depreciation*

The merchandise' shipment must be done at carriage paid by the customer.

Condizioni generali di vendita

Prezzi

I prezzi di questo listino e qualsiasi annesso che pubblicheremo dovranno considerarsi prezzi di vendita raccomandati per il cliente finale prima delle imposte.

I prezzi sono soggetti a qualsiasi variazione tenendo conto delle circostanze di mercato, materie prime, mano d'opera, imposte, etc, e si fattureranno secondo le condizioni al momento della spedizione.

Ordini

Si considereranno condizionali e soggetti portando alle nostre valutazioni.

Design

I nostri modelli potranno subire modifiche legate alle esigenze di design, senza avviso previo, sempre e comunque a beneficio dell'articolo stesso. La documentazione fotografica e/o il design tecnico riprodotto nel listino, catalogo, foglietti ed altri strumenti pubblicitari hanno un valore indicativo, perciò il cliente non potrà in nessun caso rifarsi ad essi nel caso di reclami a causa di differenze con i prodotti somministrati. Le reclamazioni dovranno realizzarsi come massimo, nei quindici giorni seguenti alla consegna della merce nel suo luogo di destinazione.

Termine di consegna

I nostri termini di consegna non sono vincolanti e non ci facciamo carico di eventuali ritardi e sue conseguenze.

Garanzie Tres Comercial SA

TRES COMERCIAL SA garantisce la sua rubinetteria in caso di difetti strutturali, di materiale o di fabbricazione per 5 anni a decorrere dalla data di fatturazione.

Per le finiture speciali (tutta la gamma di colori, acciaio, rame, ottone invecchiato, cromatura opaca, oro, oro opaco, legno e altre finiture speciali) la garanzia è di 2 anni per la finitura superficiale e di 5 anni per i componenti meccanici.

I modelli elettronici (eccetto i prodotti Shower Technology Blue Edition), colonne, cartuccia termostatica e temporizzati hanno una garanzia di 2 anni. I complementi e accessori (flessibili, docce a mano, soffioni, supporti, rubinetti d'arresto, ecc.) hanno una garanzia di 2 anni.

I materiali di consumo (filtri, guarnizioni, rompigetto...) non sono coperti dalla presente garanzia eccetto nel caso presentino difetti di fabbricazione.

Servizi sotto garanzia

TRES COMERCIAL SA ha la facoltà di decidere, in base alla tipologia del prodotto, le operazioni da effettuare: la riparazione presso gli stabilimenti di TRES o la sostituzione con un nuovo articolo escluse le spese di installazione.

Condizioni ed esclusioni

L'inadempimento di queste istruzioni esonera TRES COMERCIAL SA da ogni responsabilità.

Le istruzioni di montaggio, uso e manutenzione sono fornite con i prodotti e sono disponibili su www.tresgriferia.com

Limiti della garanzia

L'eventuale riparazione, sostituzione o qualsiasi prestazione di servizio sul prodotto interessato non estende il periodo di garanzia.

Affinché tale garanzia sia valida, è necessaria in ogni caso l'accettazione del difetto da parte del nostro ufficio tecnico.

La nostra garanzia copre solo la sostituzione del materiale senza costi aggiuntivi e in nessun caso saremo responsabili dei danni che detto difetto possa aver arrecato direttamente o indirettamente, né delle spese di installazione.

Foro competente

La buona fede che regge le relazioni di TRES COMERCIAL SA con tutti i suoi clienti e il nostro desiderio di risolvere ogni divergenza per via amichevole non contempla l'eventualità di reclami giudiziari. Nonostante, prevedendone l'improbabile caso, le parti si sommetteranno ai tribunali di Barcellona con espressa rinuncia a qualsiasi altro foro.

TRES GRIFERÍA

C/ Penedès, 16-26 | Zona Industrial, Sector A
08759 Vallirana (Barcelona) | Spagna

Accettazione condizioni

Ogni ordine ricevuto implica l'accettazione formale di queste condizioni, a meno che non se ne siano accordate altre per iscritto.

Pagamenti

Gli importi fatturati, salvo accordi speciali, saranno onorati attraverso bonifico bancario come massimo a 30 giorni dalla data di emissione della fattura. Per termini superiori verranno applicati interessi. In caso in cui esistano debiti scaduti e non pagati, ci riserviamo il diritto di annullare gli ordini in corso.

Riserva di dominio

TRES COMERCIAL SA sarà proprietaria di tutti i prodotti consegnati ai clienti fino al pagamento completo delle relative fatture.

MOLTO IMPORTANTE

Resi

TRES COMERCIAL SA non accetterà nessun reso di merce, senza che previamente il nostro agente la abbia accettato e comunicato.

- 1) TRES COMERCIAL SA non accetta nessun reso senza accettazione previa (la merce si restituirà al mittente)
- 2) TRES COMERCIAL SA non accetta nessun reso di merce che possa essere riparata con Ricambi Originali.
- 3) TRES COMERCIAL SA non accetta nessun reso di merce al di fuori della garanzia.
- 4) Nonostante, in caso di ricevere merce perfettamente

imballata, essa sarà soggetta ad un deprezzamento in fattura di:

- Se è del anno in corso: *-15% deprezzamento*
- Se e' anteriore a due anni: *-30% deprezzamento*
- Se e' anteriore a tre anni: *-30% deprezzamento*

L'invio di merce dovrà effettuarsi a porto franco da parte del cliente.

Všeobecné podmínky prodeje

Ceny

Ceny nezahrnují daně a náklady na dopravu z našich skladů. Ceny uvedené v sazebníku a v každé ze zveřejněných příloh jsou považovány "doporučené prodejní ceny pro konečné zákazníky, bez daně". Ceny se mohou měnit dle situace na trhu, surovinových nákladů, ceny práce, výše daní a jiných okolností, faktury budou vystavovány se zohledněním cen platných ke dni vystavení.

Objednávky

Pro jejich platnost je nutné, aby byly námi předem potvrzeny.

Design

Typy našich produktů se mohou měnit z technických důvodů a bez předchozího oznámení, vždy se bude jednat o změny příznivé pro daný sortiment.

Fotografická dokumentace nebo technické výkresy uvedené na kartách produktů, v katalogích, letáčích a jiných reklamních materiálech mají výhradně informační charakter. Zákazníci se v této souvislosti nemohou odvolávat na rozdíly mezi nabídkou a dodaným produktem a tyto reklamovat. Reklamace týkající se nesouladu dodaného produktu nutno uplatnit nejpozději ve lhůtě dvou týdnů ode dne dodání produktu na místo určení.

Dodací lhůty

Námi uváděné dodací lhůty jsou výhradně přibližnými termíny, z tohoto důvodu neneseme zodpovědnost za následky způsobené jakéhokoliv zpožděním.

Záruka společnosti Tres Comercial SA

Společnost TRES COMERCIAL SA poskytuje záruku na své vodovodní baterie v případě jakýchkoli konstrukčních, materiálových nebo výrobních vad po dobu pěti let od data fakturace.

Pro produkty se speciální povrchovou úpravou (v celé řadě barev, oceli, mědi, staré mosazi, matném chromu, zlatě, matném zlatě, dřevu a dalších speciálních úpravách) poskytuje dvouletou záruku na povrchovou úpravu a pětiletou záruku na mechanické součásti.

Elektronické modely (kromě produktů Shower Technology Blue Edition), sloupce, termostatická kartuše a samočinné uzavírací ventily mají záruku dvouletou.

Příslušenství a doplňky (pružné hadice, ruční sprchy, kroupka, držáky, kohoutky atd.) mají záruku dvouletou.

Na spotřební materiály (filtry, spoje, provzdušňovače atd.) se tato záruka nevztahuje, vyjma případů, kdy se prokážou výrobní vady.

Služby poskytované v záruční době

Společnost TRES má pravomoc rozhodnout o způsobu vyřízení incidentu podle typologie daného produktu. Rozhoduje mezi opravou produktu v instalacích společnosti TRES COMERCIAL SA a výměnou za nový produkt, přičemž nejsou zahrnuty náklady na instalaci.

Podmínky a vyloučení

Nedodržení pokynů v návodu zbavuje společnost TRES COMERCIAL SA veškeré zodpovědnosti.

Návody k instalaci, používání a údržbě jsou součástí každého produktu, a také jsou dostupné na www.tresgriferia.com

Omezení záruky

Případná oprava, výměna nebo jakékoli poskytnutí služby za dotčený produkt neznamená následně prodloužení záruky.

Aby byla tato záruka platná, je v každém případě nutné, aby vadu přijalo naše technické oddělení.

Naše záruka pokrývá pouze náhradu materiálu, nevztahuje se na žádné náklady. V žádném případě nemůžeme přebírat odpovědnost za škody, k nimž mohlo přímo či nepřímo dojít v důsledku vady materiálu, a ani za náklady na instalaci.

Soudní příslušnost

Dobrá víra, kterou se řídí vztahy společnosti TRES COMERCIAL SA se všemi klienty, a naše přání vyřešit všechny rozpory přátelskými prostředky nedávají prostor k přemýšlení o předkládání právních nároků před soudem. Nicméně kdyby k takovému nepravděpodobnému případu došlo, obě zúčastněné strany se podrobí soudům v Barceloně a výslovně se vzdávají jakékoli jiné soudní příslušnosti.

TRES GRIFERÍA

C/ Penedès, 16-26 | Zona Industrial, Sector A
08759 Vallirana (Barcelona) | Španělsko

Souhlas s podmínkami

Příjetí jakékoli objednávky předpokládá formální souhlas s těmito podmínkami, pokud není písemně dohodnuto jinak.

Platby

Kromě speciálních smluv budou veškeré platby prováděny převodem nejpozději ve lhůtě do 30 dnů ode vystavení faktury. V případě plateb realizovaných po této lhůtě budou účtovány dodatečné poplatky.

V případě prodlení plateb po lhůtě splatnosti si vyhrazujeme právo odmítnout vyřízení dalších objednávek.

Ustanovení týkající se vlastnictví

TRES COMERCIAL SA zůstává majitelem veškerých produktů dodaných zákazníkovi až do dne provedení úplné úhrady faktury.

VELMI DŮLEŽITÉ

Vratky zboží

TRES COMERCIAL SA nepřijímá žádné vratky zboží bez předchozího souhlasu a příslušné informace ze strany našeho zástupce.

1) TRES COMERCIAL SA nepřijímá žádné vratky zboží bez předchozího odsouhlasení. (Zboží bude vráceno odesílateli)

2) TRES COMERCIAL SA nepřijímá žádné vratky zboží, které by bylo možno opravit s použitím originálních náhradních dílů.

3) TRES COMERCIAL SA nepřijímá žádné vratky zboží po vypršení záruční lhůty.

4) V případě vrácení zboží v původním balení bude cena zboží snížena podle ceny uvedené na faktuře takto:

- Je-li faktura z běžného roku: *-15% snížení ceny*
- Je-li faktura starší dvou let: *-30% snížení ceny*
- Je-li faktura starší tří let: *-30% snížení ceny*

Náklady na odeslání zboží hradí zákazník.



TRÉS

www.tresgriferia.com

C/ Penedès, 16-26
Zona Industrial, Sector A
08759 Vallirana (Barcelona)

+34 93 683 40 27
expottres@tresgriferia.com



EN-1111:2008



REF. 7342021040 / ED. 03-2021