

Onyx Diamond

MARBLE & ONYX
COLLECTION



Tagina
ITALY'S BEST SURFACES

WATCH VIDEO



Onyx Diamond

ISPIRAZIONE 4

Inspiration.
Inspiration.
Inspiration.

LA SUPERFICIE 6

The surface.
Les surface.
Die Oberfläche.

CARATTERISTICHE DEL PROGETTO 8

Project Features.
Caractéristique du projet.
Merkmale des Projekts.

COLLECTION OVERVIEW 10

GALLERY 13

TECHNICAL INFO 55



ABBINARE COLORI E STILI 66

Matching Colours and Styles.
Faire correspondre les couleurs et les styles.
Kombination von Farben und Stilen.

PEZZI SPECIALI 68

Special pieces.
Pièces spéciales.
Formteile.



CARATTERISTICHE TECNICHE 70

Technical features.
Caractéristiques techniques.
Technische Eigenschaften.



... la percezione di un'aura di esclusività e prestigio, quasi come se le superfici avessero una storia da raccontare e un valore che va oltre la materia stessa, per lasciare spazio alla contemplazione.

... the perception of an aura of exclusivity and prestige, almost as if the surfaces had a story to tell and a value that goes beyond the material itself, to leave room for contemplation.

... la perception d'une aura d'exclusivité et de prestige, comme si les surfaces avaient une histoire à raconter et une valeur qui va au-delà de la matière elle-même, pour laisser place à la contemplation.

... die Wahrnehmung einer Aura von Exklusivität und Prestige, fast so, als hätten die Oberflächen eine Geschichte zu erzählen und einen Wert zu geben, der über die Materie selbst hinausgeht, um Raum für Kontemplation zu lassen.

Ispirazione

Inspiration
Inspiration
Inspiration

Un'ispirazione che nasce dal cuore della terra, dove l'onice, gemma millenaria, si fonde coi riflessi del diamante. ONYX DIAMOND cattura l'essenza di questa alchimia preziosa, trasformandola in materia. Le candide e sinuose venature dell'onice, come percorsi segreti, si illuminano di riflessi cangianti, evocando lo scintillio delle mille sfaccettature dei diamanti. Una danza di luce e ombra, di colori e sfumature, in cui la materia si anima, rivelando la sua essenza più preziosa.

An inspiration that comes from the heart of the earth, where onyx, an ancient gem, blends with the reflections of diamond. ONYX DIAMOND captures the essence of this precious alchemy, transforming it into matter. The white and sinuous veins of the onyx, like secret paths, are lit by changing reflections, evoking the sparkle of the thousand facets of diamonds. A dance of light and shadow, of colours and shades, in which matter comes to life, revealing its most precious soul.

Une inspiration qui naît du cœur de la terre, où l'onyx, gemme millénaire, se confond avec les reflets du diamant. ONYX DIAMOND capture l'essence de cette alchimie précieuse, en la transformant en matière. Les veines blanches et sinueuses de l'onyx, comme des chemins secrets, s'illuminent de reflets changeants, évoquant le scintillement des mille facettes des diamants. Une danse de lumière et d'ombre, de couleurs et de nuances, dans laquelle la matière s'anime, révélant son âme la plus précieuse.

Eine Inspiration, die aus der Mitte der Erde kommt, wo der Onyx, ein tausendjähriges Juwel, mit den Reflexen des Diamanten verschmilzt. ONYX DIAMOND fängt die Essenz dieser kostbaren Alchemie ein und verwandelt sie in Materie. Die weiße und gewundene Maserung des Onyx leuchtet wie geheime Pfade mit schillernden Reflexen auf und erinnert an das Funkeln der tausend Facetten von Diamanten. Ein Tanz aus Licht und Schatten, Farben und Schattierungen, das die Materie weckt und ihre kostbarste Seele offenbart.



La superficie

The surface

La surface

Die Oberfläche

Un connubio perfetto tra eleganza e preziosità, finora inimmaginabile.

A perfect combination of elegance and preciousness,
hitherto unimaginable.

Un mariage parfait entre élégance et préciosité,
jusqu'alors inimaginable.

Eine perfekte Kombination aus Eleganz und
Kostbarkeit, bisher unvorstellbar.

Brilla, seduce, incanta

Shines, seduces, enchants.

Elle brille, séduit, enchante.

Er glänzt, verführt, verzaubert.

L'innovativa tecnologia "Diamond Shard Effect" integra microcristalli ad alta rifrazione che si esaltano con la lucidatura della superficie. Il risultato è un effetto estetico di straordinaria profondità visiva: un gioco di luci e ombre, creato dalla disposizione dei cristalli distribuiti in armonia con le venature dell'onice, che dona alla superficie un aspetto tridimensionale, come le sfaccettature di un diamante.

The innovative "Diamond Shard Effect" technology integrates highly refractive microcrystals that are enhanced by the polishing of the surface. The result is an aesthetic effect of extraordinary visual depth: a play of light and shadow, created by the arrangement of the crystals harmoniously distributed along the onyx veining, giving the surface a three-dimensional look reminiscent of a diamond's facets.

La technologie innovante « Diamond Shard Effect » intègre des microcristaux à haute réfraction sublimés par un polissage méticuleux de la surface. Le résultat est un effet esthétique d'une extraordinaire profondeur visuelle : un jeu de lumières et d'ombres, créé par la disposition des cristaux distribués en harmonie avec les veines de l'onyx, qui donne à la surface un aspect tridimensionnel comme les facettes d'un diamant. »

Die innovative „Diamond Shard Effect“-Technologie integriert hochbrechende Mikrokristalle, die durch die Oberflächenpolitur hervorgehoben werden. Das Ergebnis ist ein ästhetischer Effekt von außergewöhnlicher visueller Tiefe: ein Spiel von Licht und Schatten, das durch die Anordnung der Kristalle, die im Einklang mit den Adern des Onyx verteilt sind, entsteht und der Oberfläche ein dreidimensionales Aussehen wie die Facetten eines Diamanten verleiht.“

NEW TECHNOLOGY >>> diamond shard effect

Lucidato e rettificato
Glossy rectified.
Brillant et rectifié.
Glossy/Shiny und rektifiziert.

Grey Agate

Caratteristiche del progetto

Project Features.

Caractéristique du projet.

Merkmale des Projekts.

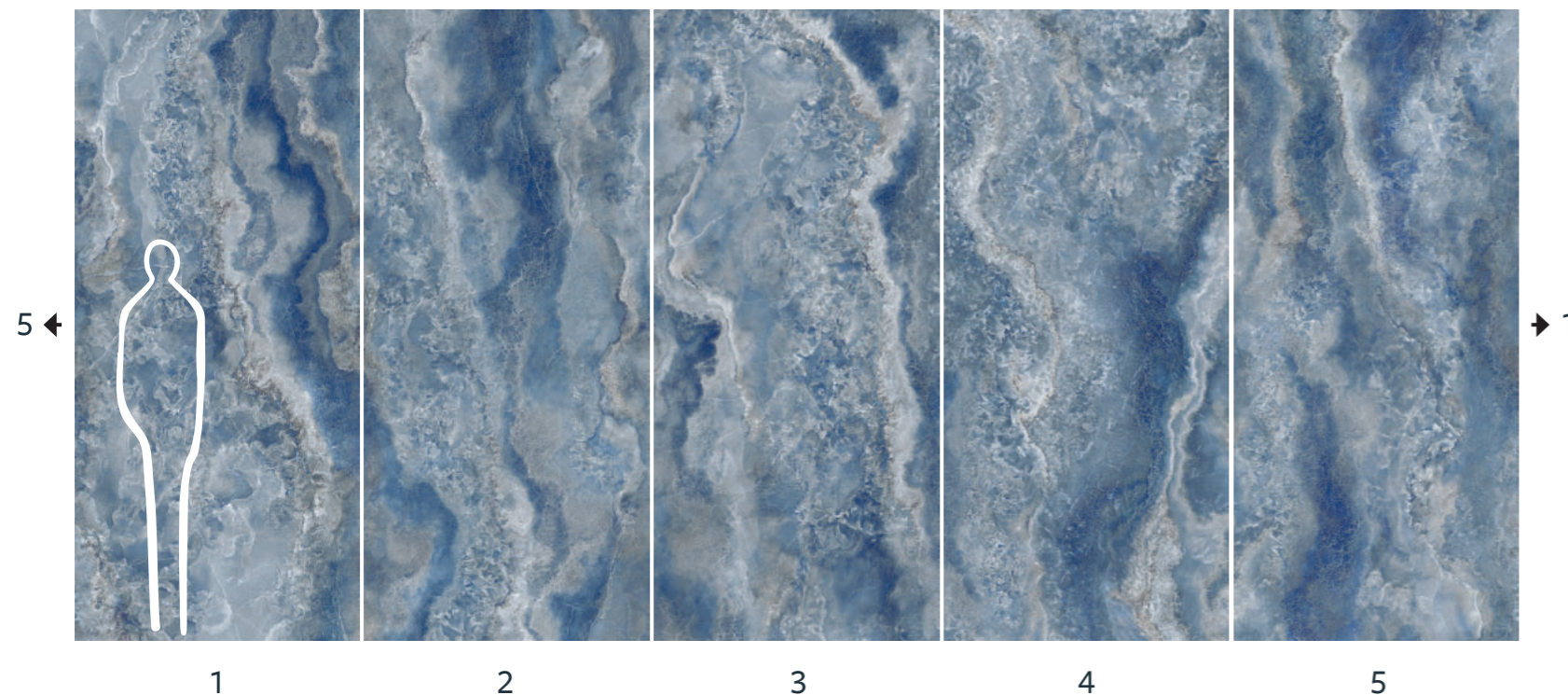

È possibile ordinare grafiche e composizioni complete a fronte di un ordine minimo di 600 m² con un sovrapprezzo del 10%.

It is possible to order full sets of prints on condition that a minimum order of 600 sqm is placed. A 10% price surcharge will be applied in such cases.

Il est possible de commander les graphismes et les compositions complètes. La quantité minimale par commande est de 600 m² avec un supplément de 10%.

Es besteht die Möglichkeit volle Sets zu bestellen, bei einer Bestellung von mindestens 600 m² mit einem Aufpreis in Höhe von 10%.

AQUARIS 120x280 Lucidato Ret.

Al fine di ottenere pose naturali e dall'alto impatto estetico, le grafiche di Onyx Diamond, nel formato 120x280, sono state studiate per poter essere posate l'una accanto all'altra senza interruzione di vena (solo sul lato da 280 cm; discontinuità di grafica max 1,5 cm).

In order to obtain natural poses with a high aesthetic impact, the Onyx Diamond graphics, in the 120x280 size, have been designed to be laid next to each other without vein interruption (only on the 280 cm side; graphics discontinuity max 1.5 cm).

Afin d'obtenir des poses naturelles et à fort impact esthétique, les graphismes d'Onyx Diamond, au format 120 x 280, ont été étudiés pour pouvoir être posés côte à côte sans interruption veineuse (uniquement sur le côté de 280 cm ; discontinuité graphique max 1,5 cm).

Um eine natürlich fortlaufende Verlegung und eine hohe ästhetische Wirkung zu erzielen, wurden die Grafiken von Onyx Diamond im Format 120x280 so konzipiert, dass sie ohne Unterbrechung der Maserung nebeneinander verlegt werden können (nur auf der Seite mit 280 cm; maximale Grafikdiskontinuität 1,5 cm).

Per esigenze di produzione, le 5 grafiche della composizione nel formato 120x280, si trovano random all'interno delle casse e dei cavalletti e non è pertanto garantito che siano tutte presenti o che lo siano in modo proporzionale l'una all'altra.

For manufacturing reasons, the 5 prints making up the 120x280 set are randomly placed on crates and A-Frames. For this reason, we are unable to guarantee that all the prints making up each set will be supplied, nor are we able to ensure that the prints will be supplied in equal numbers.

En faisant suite aux exigences de production, les 5 graphismes de la composition en format 120x280, sont mélangés par hasard dans les boîtes et les supports. Il n'est donc pas garanti que les graphismes soient tous présents ou bien qu'ils le soient de manière proportionnelle les uns aux autres.

Aufgrund produktiver Einschränkungen ist das Set aller 5 Grafiken in 120x280 in den Kisten und auf Gestell nicht garantiert, weder proportional noch der Anzahl nach.

Collection overview

Disponibile in 7 colori eleganti nei formati 120x280, 120x120 e 60x120, questa collezione si inserisce perfettamente in ambienti contemporanei, offrendo una soluzione estetica raffinata per progetti che esigono esclusività e qualità impeccabile.

Available in 7 elegant colours in the 120x280, 120x120 and 60x120 sizes, this collection fits perfectly into contemporary spaces, offering a refined aesthetic solution for projects that demand exclusivity and impeccable quality.

Disponibile en 7 couleurs élégantes dans les formats 120 x 280, 120 x 120 et 60 x 120, cette collection s'intègre parfaitement dans les espaces contemporains, offrant une solution esthétique raffinée pour les projets qui exigent exclusivité et qualité irréprochable.

Diese Kollektion ist in 7 eleganten Farben in den Formaten 120x280, 120x120 und 60x120 erhältlich und fügt sich perfekt in zeitgenössische Umgebungen ein und bietet eine raffinierte ästhetische Lösung für Projekte, die Exklusivität und einwandfreie Qualität erfordern.



Onyx Diamond



INDOOR

SHADE SPECTRUM V3

FORMATO . SIZE . FORMAT . FORMAT	120x280 48"x110"	120x120 48"x48"	60x120 24"x48"	30x30 12"x12"
SPESORE . THICKNESS . EPAISSEUR . STÄRKE	6 mm	9 mm	9 mm	9 mm
N° DI GRAFICHE . No OF GRAPHICS . N° DE GRAPHISMES . Nr DER GRAFIKEN	5	10	20	
BRIGHT ○ Lucidato Ret.	●	●	●	●
CHAMPAGNE ○ Lucidato Ret.	●	●	●	●
GREY AGATE ○ Lucidato Ret.	●	●	●	●
FLAMINGO ○ Lucidato Ret.	●	●	●	●
AQUARIS ○ Lucidato Ret.	●	●	●	●
BLUMARINE ○ Lucidato Ret.	●	●	●	●
EMERALD ○ Lucidato Ret.	●	●	●	●



G A L L E R Y



È come varcare la soglia di un mondo di eleganza, luce e raffinatezza. Le superfici dell'ambiente, creano un'atmosfera intima che invita a rallentare il passo per sperimentare una coinvolgente esperienza sensoriale.

It is like crossing the threshold of a world of elegance, light and refinement. The surfaces of the space create an intimate atmosphere inviting to slow down and experience an engaging sensory experience.

C'est comme franchir le seuil d'un monde d'élégance, de lumière et de raffinement. Les surfaces de l'espace créent une atmosphère intime qui vous invite à ralentir le pas pour vivre une expérience sensorielle immersive.

Es ist, als würde man die Schwelle zu einer Welt der Eleganz, des Lichts und der Raffinesse überschreiten. Die Oberflächen der Umgebung schaffen eine intime Atmosphäre, die dazu einlädt, das Tempo zu verlangsamen, um ein fesselndes sensorisches Erlebnis zu erfahren.

RIVESTIMENTO - WALL
CHAMPAGNE 120x280 Lucidato Ret.
BRIGHT 120x280 Lucidato Ret.

PARETE CAMINO - FIREPLACE WALL
CHAMPAGNE 120x280 Lucidato Ret.

PAVIMENTO - FLOOR
CHAMPAGNE 120x120 Lucidato Ret.
BRIGHT 120x120 Lucidato Ret.





 CHAMPAGNE

RIVESTIMENTO - WALL
CHAMPAGNE 120x280 Lucidato Ret.

PAVIMENTO - FLOOR
CHAMPAGNE 120x120 Lucidato Ret.



RIVESTIMENTO . WALL
CHAMPAGNE 120x280 Lucidato Ret.

PAVIMENTO . FLOOR
CHAMPAGNE 120x120 Lucidato Ret.



RIVESTIMENTO . WALL
BRIGHT 120x280 Lucidato Ret.

TOP
BRIGHT 120x280 Lucidato Ret.

PAVIMENTO . FLOOR
BRIGHT 120x120 Lucidato Ret.



BRIGHT



RIVESTIMENTO . WALL
BRIGHT 120x280 Lucidato Ret.

TOP
BRIGHT 120x280 Lucidato Ret.

PAVIMENTO . FLOOR
BRIGHT 120x120 Lucidato Ret.





BRIGHT Mosaico 30x30 Lucidato Ret.
BRIGHT 120x280 Lucidato Ret.
BRIGHT Coprispigo triangolare 0,8x120 Lucidato Ret.



RIVESTIMENTO . WALL
GREY AGATE 120x280 Lucidato Ret.
BRIGHT 120x280 Lucidato Ret.

PARETE CAMINO . FIREPLACE WALL
GREY AGATE 120x280 Lucidato Ret.

ARREDI . FURNITURE
GREY AGATE 120x280 Lucidato Ret.

PAVIMENTO . FLOOR
GREY AGATE 120x120 Lucidato Ret.

 GREY AGATE



RIVESTIMENTO . WALL
GREY AGATE 120x280 Lucidato Ret.
PAVIMENTO . FLOOR
GREY AGATE 120x120 Lucidato Ret.







RIVESTIMENTO - WALL
BLUMARINE 120x280 Lucidato Ret.
Collection STEEL, IRIDIO 120x280 Satinato Ret.

VASCA - BATHTUB
BLUMARINE 120x280 Lucidato Ret.

GRADINO - STEP TREAD
Collection STEEL, IRIDIO 60x120 Satinato Ret.
Collection STEEL, IRIDIO Coprispigo triangolare 1,4x120 Satinato Ret.

TOP
Collection STEEL, IRIDIO 120x280 Satinato Ret.

PAVIMENTO - FLOOR
BLUMARINE 60x120 Lucidato Ret.

RIVESTIMENTO - WALL
BLUMARINE 120x280 Lucidato Ret.

VASCA - BATHTUB
BLUMARINE 120x280 Lucidato Ret.

GRADINO - STEP TREAD
Collection STEEL, IRIDIO 60x120 Satinato Ret.
Collection STEEL, IRIDIO Coprispigo triangolare 1,4x120 Satinato Ret.

PAVIMENTO - FLOOR
BLUMARINE 60x120 Lucidato Ret.



RIVESTIMENTO . WALL
BLUMARINE 120x280 Lucidato Ret.

VASCA . BATHTUB
BLUMARINE 120x280 Lucidato Ret.

GRADINO . STEP TREAD
Collection STEEL, IRIDIO 60x120 Satinato Ret.
Collection STEEL, IRIDIO Coprispigolo triangolare 1,4x120 Satinato Ret.

PAVIMENTO . FLOOR
BLUMARINE 60x120 Lucidato Ret.

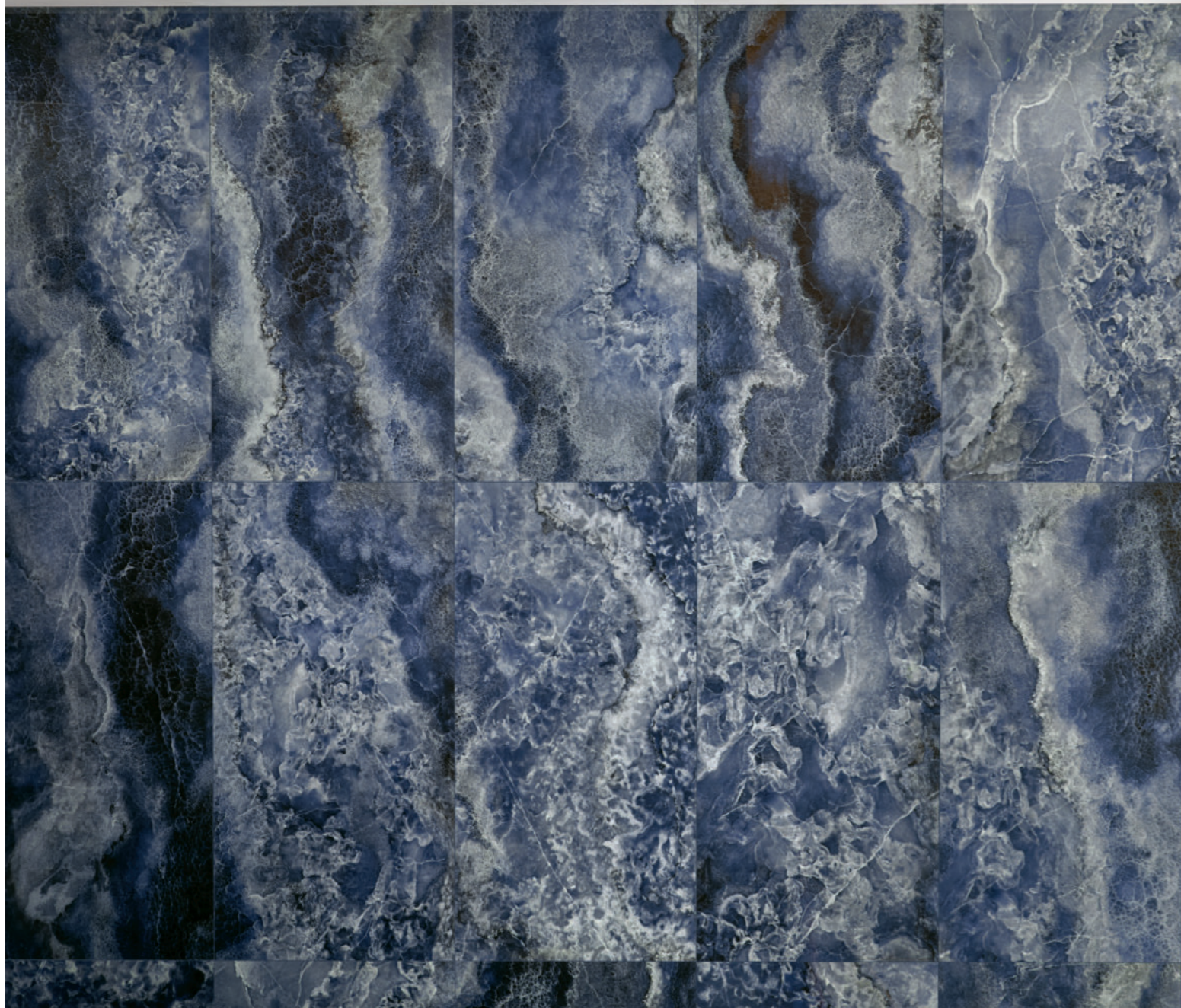

RIVESTIMENTO . WALL
AQUARIS 120x280 Lucidato Ret.
BRIGHT 120x280 Lucidato Ret.

PAVIMENTO . FLOOR
AQUARIS 60x120 Lucidato Ret.



AQUARIS

RIVESTIMENTO . WALL
AQUARIS 120x280 Lucidato Ret.
BRIGHT 120x280 Lucidato Ret.

PAVIMENTO . FLOOR
AQUARIS 60x120 Lucidato Ret.



RIVESTIMENTO . WALL
AQUARIS 120x280 Lucidato Ret.
PAVIMENTO . FLOOR
AQUARIS 60x120 Lucidato Ret.





FLAMINGO



FLAMINGO 120x280 Lucidato Ret.

RIVESTIMENTO . WALL
EMERALD 120x280 Lucidato Ret.

PAVIMENTO . FLOOR
EMERALD 120x120 Lucidato Ret.

< Room 101-121

 EMERALD

Hotel Emerald *****

RIVESTIMENTO . WALL
EMERALD 120x280 Lucidato Ret.

PAVIMENTO . FLOOR
EMERALD 120x120 Lucidato Ret.





RIVESTIMENTO . WALL
EMERALD 120x280 Lucidato Ret.

PAVIMENTO . FLOOR
EMERALD 120x120 Lucidato Ret.

TECHNICAL INFO



1:1 🔍

BRIGHT



GREY AGATE

🔍 1:1



1:1 🔍

FLAMINGO

CHAMPAGNE

🔍 1:1

1:1 Q

AQUARIS

BLUMARINE

Q 1:1

1:1 🔍

EMERALD

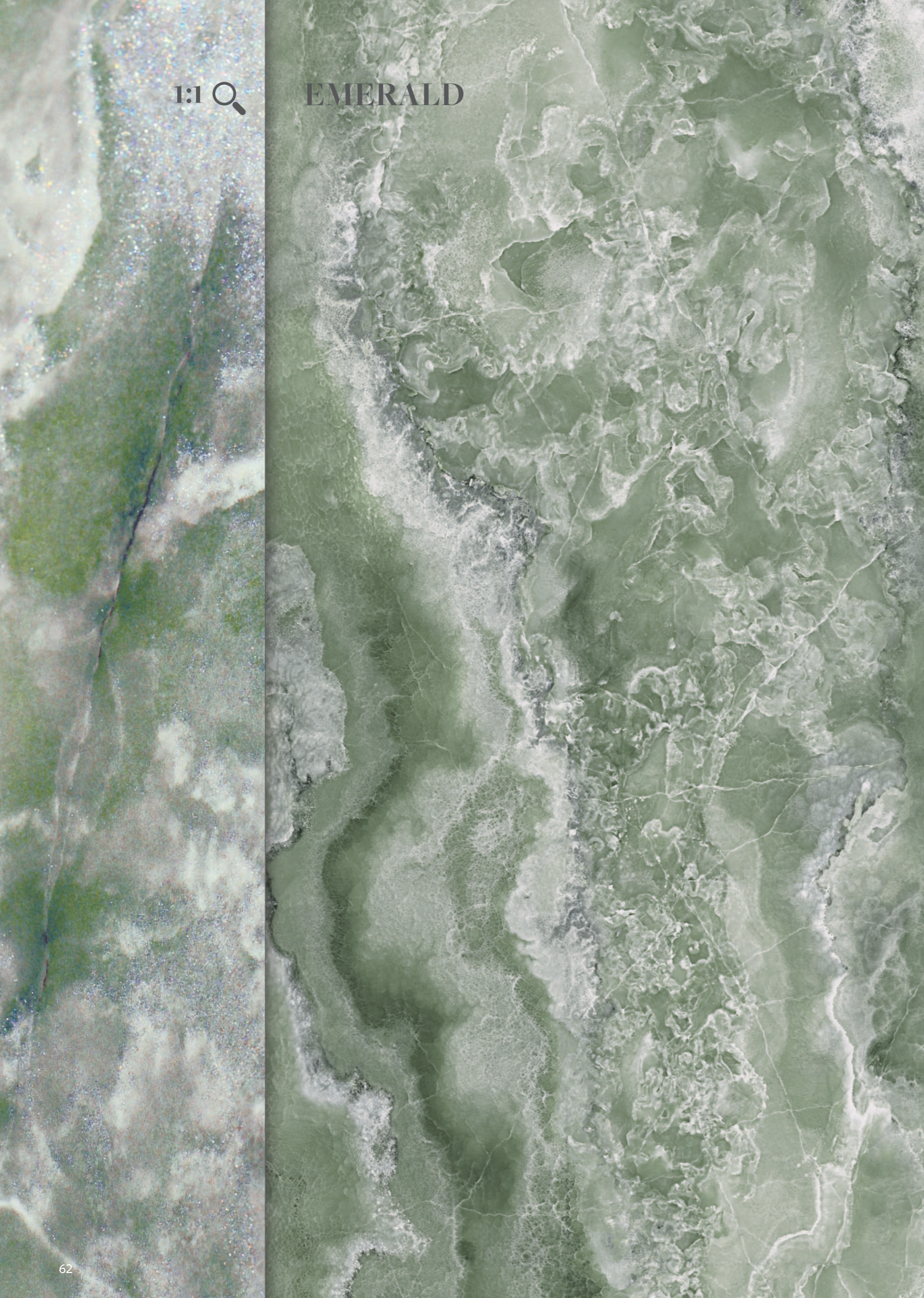

Spessore . Thickness . Epaisseur . Stärke - 6 mm

Lastre in gres porcellanato pressate a secco. Dry-pressed porcelain stoneware slabs. Dalles en grès cérame pressées à sec. Trocken gepresste Platten aus Feinsteinzeug.

Spessore . Thickness . Epaisseur . Stärke - 9 mm

Gres porcellanato colorato in massa. Full-body coloured porcelain stoneware. Grès cérame coloré dans la masse. In der Masse gefärbtes Feinsteinzeug.

INDOOR

TABELLA RIEPILOGATIVA
Summary table
Tableau récapitulatif
Zusammenfassenden Tabelle



120x280
48"x110"



120x120
48"x48"



60x120
24"x48"



Mosaico (5x5)
30x30
12"x12"



***** Coprispigolo triangolare**
0,8x120
¼"x48"

1,4x120
½"x48"



Ang. Coprispigolo triangolare
0,8x0,8
¼"x¼"

1,4x1,4
½"x½"



Battiscopa
6,3x120
2 ½"x48"

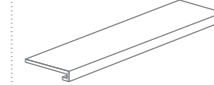

*** Gradino a C**
33x120x3,2h
13"x48"x1 ¼" h



*** Ang. Gradino a C - SX**
33x120x3,2h
13"x48"x1 ¼" h

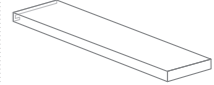

*** Ang. Gradino a C - DX**
33x120x3,2h
13"x48"x1 ¼" h

SPESSORE - THICKNESS - EPAISSEUR - STÄRKE		6 mm	9 mm	9 mm	9 mm	9 mm	6 mm	9 mm	6 mm	9 mm	9 mm	9 mm	9 mm	
	BRIGHT ○ Lucidato Ret.	148001	148021	148041	148301		148401	148415	148443	148457	148101	148201	148229	148257
	CHAMPAGNE ○ Lucidato Ret.	148003	148023	148043	148303		148403	148417	148445	148459	148103	148203	148231	148259
	GREY AGATE ○ Lucidato Ret.	148005	148025	148045	148305		148405	148419	148447	148461	148105	148205	148233	148261
	FLAMINGO ○ Lucidato Ret.	148009	148029	148049	148307		148407	148421	148449	148463	148107	148207	148235	148263
	AQUARIS ○ Lucidato Ret.	148015	148035	148055	148309		148409	148423	148451	148465	148109	148209	148237	148265
	BLUMARINE ○ Lucidato Ret.	148013	148033	148053	148311		148411	148425	148453	148467	148111	148211	148239	148267
	EMERALD ○ Lucidato Ret.	148011	148031	148051	148313		148413	148427	148455	148469	148113	148213	148241	148269
MQ x pezzo - Sqm x pcs		3,36												
Kg x pezzo - Kg x pcs		48,6												
IMBALLI - PACKAGING EMBALLAGE - VERPACKUNG														
		Cassa Crate 145x292x34h	Cavalletto A-Frame 75x290x160h	Pallet speciale Special pallet 123x144	Pallet 80x120	Pallet 80x120	Pallet 80x120	Pallet 80x120	Pallet 80x120	Pallet 80x120	Pallet 80x120	Pallet 80x120	Pallet 80x120	Pallet 80x120
N°		20	44											
m²		67,2	147,84											
Kg		1062	2259											
				2	2	11	6	6			9	2	1	1
m² x				2,88	1,44	0,99					14,2	21	10,5	10,5
Kg x				58	29	19,5								
				18	30									
m² x				51,84	43,2									
** Kg x				1097	890									
h x				65	75									
Imballo (tara) - Packaging (tare)		(90)	(120)	(53)	(20)						(20)	(20)	(20)	(20)

I pesi riportati in tabella sono indicativi e potrebbero essere soggetti a leggere variazioni.
The weights stated in the chart may undergo slight changes for production reasons.
Les poids indiqués dans le tableau peuvent subir de légères variations pour des raisons de production.
Die in der Tabelle angegebenen Gewichte können aus Produktionsgründen geringfügigen Abweichungen unterliegen.

Non si garantisce l'abbinabilità tra fondi di spessori diversi e tra fondo e pezzo speciale.
It is not guaranteed that background tiles with different thicknesses can be used together, nor is it guaranteed for background tiles and trims.
Nous ne garantissons pas la possibilité de combiner des carrelages de sol de différentes épaisseurs et un carrelage de sol avec une pièce spéciale.
Die Kombinierbarkeit von Fliesen unterschiedlicher Stärke sowie zwischen Fliese und Formteil kann nicht garantiert werden.

* A disposizione solo su richiesta. Tempi di consegna 30 gg.
Available upon request only. Delivery terms: 30 days.
Disponible seulement sur requête. Délais de livraison: 30 jours.
Verfügbar auf Anfrage. Lieferzeit: 30 Tage.

** Il peso è comprensivo dell'imballo.
The total weight includes the packaging.
Le poids comprend aussi l'emballage.
Das Gesamtgewicht enthält auch die Verpackung.

*** Vendita a scatola completa.
Full box sale.
Vente à la boîte complète.
Volle Kartons.

○ Lucidato e rettificato.
Glossy rectified.
Brillant et rectifié.
Glossy/Shiny und rektifiziert.

Suggerimenti per abbinare colori e stili Tagina

Tips for Matching Colours and Tagina Styles.
 Conseils pour faire correspondre les couleurs et les styles Tagina.
 Tipps für die Kombination von Tagina-Farben und -Stilen.



BRIGHT

CHAMPAGNE

GREY AGATE

FLAMINGO

AQUARIS

BLUMARINE

EMERALD

	BRIGHT	CHAMPAGNE	GREY AGATE	FLAMINGO	AQUARIS	BLUMARINE	EMERALD
MARBLE & ONYX ONYX DIAMOND ONYX DIAMOND	 CHAMPAGNE	 BRIGHT	 BRIGHT				
CONCRETE & DESIGN ONYX DIAMOND STEEL	 GRAFITE	 IRIDIO	 IRIDIO	 IRIDIO	 IRIDIO	 ARGENTO	 IRIDIO
STONE & CLASSIC ONYX DIAMOND PIETRA D'ORVIETO	 CENERE	 SABBIA	 BIANCO	 BIANCO	 CENERE	 BIANCO	 BIANCO
WOOD ONYX DIAMOND MONTALCINO	 PAGLIERINO	 MIELE	 MIELE	 MIELE			
ONYX DIAMOND EVOQUE	 KORINA	 BAHIA	 BAHIA	 KORINA	 KORINA		 KORINA
Colore consigliato per la Fuga Recommended joint colour. Couleur d'échappement recommandée. Empfohlene Farbe für die Fuge.	 RAL 9016 NCS 0510-R	 RAL 1019 NCS 4010-Y30R	 RAL 7038 NCS 2502-B	 RAL 9001 NCS 0903-Y27R	 RAL 7001 NCS 4005-R80B	 RAL 7011 NCS 7005-B20G	 RAL 7033 NCS 5005-G50Y

Pezzi speciali: massima cura in ogni dettaglio

Special pieces: the utmost care in every detail.

Pièces spéciales : le soin maximal dans le moindre détail.

Formteile: maximale Sorgfalt in jedem Detail.



Il fascino tradizionale del gradino a "C"

The traditional appeal of the "C" step.

Le charme traditionnel de l'étape « C ».

Der traditionelle Charme der „C“-Stufe.

Tagina pone attenzione a tutte le componenti architettoniche degli spazi da abitare. Ai gradini sono dedicati pezzi speciali appositamente progettati per ottenere il massimo risultato estetico. La gamma comprende un elemento "gradino a C" al quale si possono affiancare gli elementi che completano gli angoli sinistro e destro.

Tagina achtet auf alle architektonischen Komponenten der Wohnräume. Den Stufen sind Spezialteile gewidmet, um ein optimales ästhetisches Ergebnis zu erzielen.

Das Sortiment umfasst ein „C-Stufen-Element“, das durch Elemente zur Vervollständigung der linken und rechten Ecke ergänzt werden kann.

Tagina takes great care over all the architectural elements of the living spaces. Special pieces are used for the stairs, specially designed to obtain the maximum aesthetic result.

The range includes a "C-step" element which can be combined with the elements that complete the left and right corners.

Tagina prête attention à toutes les composantes architecturales des espaces de vie. Les étapes sont dédiées à des pièces spéciales spécialement conçues pour obtenir un résultat esthétique maximal. La gamme comprend un élément « marche en C » auquel vous pouvez assortir les autres éléments qui complètent les angles gauche et droit.

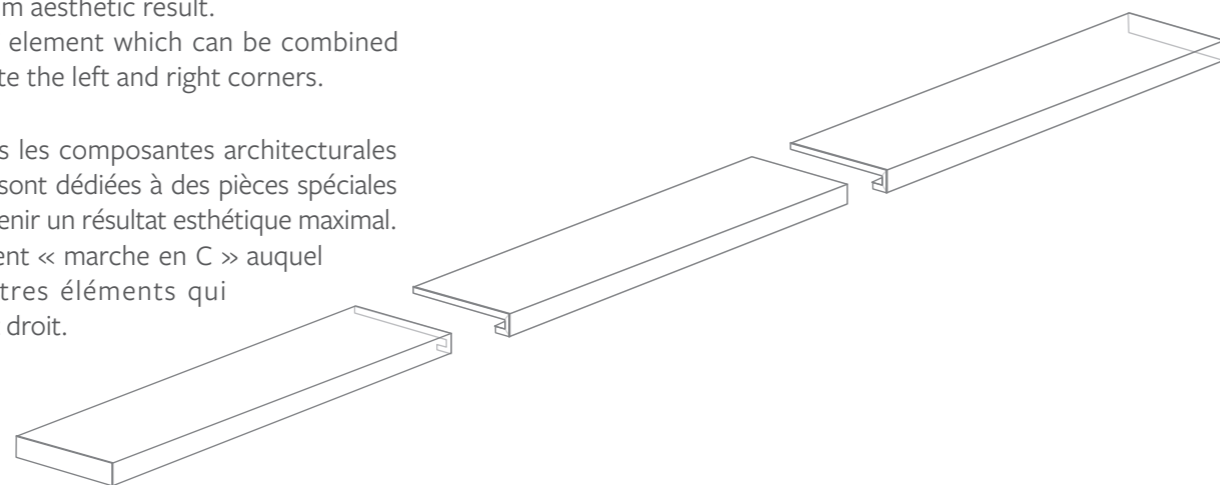

Il "coprispigo triangolare"

The "triangular edge cover".

Le « cache-arête triangulaire ».

„Dreieckiger Kantenschutz“.

La gamma della collezione include l'elemento "Coprispigo triangolare" e "Angolo Coprispigo triangolare". Consentono di risolvere con eleganza e semplicità problematiche legate alla congiunzione delle lastre in presenza di spigoli e angoli. È possibile adottare questa soluzione sia a rivestimento che a pavimento ad esempio per realizzare gradini o per comporre volumi geometrici.

The range of the collection includes the "Triangular edge cover and triangular corner edge cover" element. They allow problems encountered to be solved elegantly and simply when joining slabs where there are edges and corners. It is possible to adopt this solution both for cladding and flooring, e.g. to create steps or compose geometric volumes.

La gamme de la collection comprend l'élément « Cache-arête triangulaire et Angle Cache-arête Triangulaire ». Ils permettent de résoudre avec élégance et simplicité les problèmes liés à l'assemblage des dalles en présence de bords et de coins. Il est possible d'adopter cette solution aussi bien pour le revêtement que pour le dallage, par exemple pour créer des marches ou composer des volumes géométriques.



Das Sortiment der Kollektion umfasst das Element „Dreieckiger Kantenschutz und Dreieckige Eckabdeckung“. Beide Elemente ermöglichen, mit Eleganz und Einfachheit alle Probleme zu lösen, die mit dem Zusammenfügen der Platten bei Vorhandensein von Kanten und Ecken zusammenhängen.

Diese Lösung kann sowohl für Verkleidungen als auch für Böden verwendet werden, beispielsweise um Stufen oder geometrische Volumen zu schaffen.

CARATTERISTICHE TECNICHE

















TECHNICAL FEATURES . CARACTERISTIQUES TECHNIQUES . TECHNISCHE EIGENSCHAFTEN .

LASTRE IN GRES PORCELLANATO PRESSATE A SECCO

Dry-pressed porcelain stoneware slabs . Dalles en grès cérame pressées à sec . Trocken gepresste Platten aus Feinsteinzeug.

GRES PORCELLANATO COLORATO IN MASSA

Full-body coloured porcelain stoneware / Grès cérame coloré dans la masse / In der Masse gefärbtes Feinsteinzeug.

CARATTERISTICA Specification Caractéristique Eigenschaft	NORMA Standards Norme Norm	RISULTATO PROVA Test results Résultats des essais Ergebnisse
 Classificazione prodotto Product classification Classification produit Produktklassifizierung	UNI EN 14411- Allegato G ISO 13006 UNI EN 14411- Appendix G ISO 13006 UNI EN 14411- Appendice G ISO 13006 UNI EN 14411- Anhang G ISO 13006	Gruppo B1a GL Group B1a GL Groupe B1a GL Gruppe B1a GL
 Caratteristiche dimensionali e d'aspetto Dimensional characteristics Caractéristiques dimensionnelles Abmessungen	UNI EN ISO 10545-2	Conforme alla norma. Complies with the standards. Conforme aux normes. Anforderungenerfüllt.
 Assorbimento di acqua Water absorption Absorption d'eau Wasseraufnahme	UNI EN ISO 10545-3	Conforme alla norma. Complies with the standards. Conforme aux normes. Anforderungenerfüllt.
 Resistenza alla flessione Breaking stress Résistance à la flexion Biegefestigkeit	UNI EN ISO 10545-4	Conforme alla norma. Complies with the standards. Conforme aux normes. Anforderungenerfüllt.
 Sforzo di rottura Breaking stress Effort de rupture Bruchkraft		Conforme alla norma. Complies with the standards. Conforme aux normes. Anforderungenerfüllt.
 Resistenza all'abrasione delle piastrelle non smaltate Deep abrasion resistance of unglazed tiles Résistance à l'abrasion profonde des carreaux non émaillés Beständig gegenüber Tiefenabrieb der unglasierten Fliesen	UNI EN ISO 10545-6	-
 Resistenza all'abrasione delle piastrelle smaltate Abrasion resistance of glazed tiles Résistance à l'abrasion des carreaux émaillés Abriebfestigkeit der glasierten Fliesen	UNI EN ISO 10545-7	Secondo quanto dichiarato. As stated by the Company. D'après déclaration de l'établissement. Entsprechend der Angaben des Unternehmens.
 Dilatazione termica lineare Linear thermal expansion Dilatation thermique linéaire Lineare Wärmedehnung	UNI EN ISO 10545-8	7x10 ⁻⁶ C ⁻¹
 Resistenza agli sbalzi termici Thermal shock resistance Résistance aux écarts thermiques Beständigkeit gegenüber Temperaturschwankungen	UNI EN ISO 10545-9	Resistente. Resistant. Résiste. Erfüllt.
 Resistenza al cavillo Crazing resistance Résistance aux craquelures Beständigkeit gegenüber Glasurrisen	UNI EN ISO 10545-11	Resistente. Resistant. Résiste. Erfüllt.
 Resistenza al gelo Frost resistance Résistance au gel Frostbeständigkeit	UNI EN ISO 10545-12	Resistente. Resistant. Résiste. Erfüllt.
 Resistenza ai prodotti chimici Chemical resistance Résistance aux produits chimiques Beständig gegenüber Chemikalien	UNI EN ISO 10545-13	Resistente. Resistant. Résiste. Erfüllt.
 Resistenza alle macchie Stain resistance Résistance aux taches Beständigkeit gegenüber Flecken	UNI EN ISO 10545-14	Resistente. Resistant. Résiste. Erfüllt.
 Stabilità dei colori alla luce Colour stability upon exposure to light Stabilité des couleurs à la lumière Stabilität der Farben gegenüber dem Licht	DIN 51094	Conforme alla norma. Complies with the standards. Conforme aux normes. Anforderungenerfüllt.
 Resistenza alla scivolosità Friction coefficient (slip level) Coefficient de friction (glissance) Reibungskoeffizient (Glätte)	DIN 51130	A richiesta. / Available on request. / Sur demande. / Anforderungenerfüllt.
	DIN 51097	A richiesta. / Available on request. / Sur demande. / Anforderungenerfüllt.
	B.C.R.A.-D.M. 236/89	A richiesta. / Available on request. / Sur demande. / Anforderungenerfüllt.
	DCOF (BOOT 3000 -section 9.6 ANSI 137.2012)	A richiesta. / Available on request. / Sur demande. / Anforderungenerfüllt.
 Resistenza al sale Salt resistance Résistance au sel Beständigkeit gegenüber Salz	NaCl	Resistente. Resistant. Résiste. Erfüllt.
 Resistenza al fuoco Reaction to fire Réaction au feu Brandschutz kaasse	UNI EN 13501-1-2009	A richiesta. Available on request. Sur demande. Anforderungenerfüllt.

INDICAZIONI PER IL TAGLIO

CUTTING INSTRUCTIONS . INDICATIONS POUR LA DÉCOUPE
HINWEISE ZUM SCHNEIDEN . 切割說明

ONYX DIAMOND è realizzata con tecnologia Diamond Shard Effect.

Data la presenza di microcristalli sulla superficie, al fine di evitare rotture durante la fase di taglio si raccomanda, per tutti i formati, di capovolgere la lastra/piastrella e di tagliarla sul retro (A). Se si utilizza il flessibile (B), la punta per grès porcellanato (C) o la fresa diamantata (D), è invece possibile tagliarla su entrambi i lati.

ONYX DIAMOND is made using 'Diamond Shard Effect' technology.

Due to the presence of microcrystals on the surface, to prevent breakages during the cutting process, for all sizes, we recommend flipping the slab/tile over and cutting it on the back (A). If using an angle grinder (B), a porcelain stoneware drill bit (C), or a diamond cutter (D), you can instead cut on both sides.

ONYX DIAMOND est réalisée avec la technologie « Diamond Shard Effect ».

En raison de la présence de micro-cristaux en surface, il est recommandé de retourner la dalle ou le carreau et de réaliser la découpe sur le verso (A) pour éviter tout risque de fissure ou de rupture. Si vous utilisez le flexible (B), la pointe pour grès cérame (C) ou la fraise diamantée (D), la découpe peut être réalisée indifféremment sur les deux faces.

ONYX DIAMOND wird mit der „Diamond Shard Effect“-Technologie hergestellt.

Wegen der Mikrokrystalle auf der Oberfläche wird empfohlen, die Platte/Fliese für alle Formate umzudrehen und auf der Rückseite (A) zu schneiden, um Brüche während der Schneidphase zu vermeiden. Wird allerdings ein Trennschleifer (B), ein Feinsteinzeugbohrer (C) oder ein Diamantfräser (D) verwendet, kann auf beiden Seiten geschnitten werden.

ONYX DIAMOND 採用「Diamond Shard Effect」技術製造。考慮到表面存在微晶體，為避免在切割階段破裂，建議對於所有規格的料板/瓷磚，都應倒置並在背面切割 (A)。如果使用砂轮机 (B)、精細瓷磚鑽頭 (C) 或金剛石鏢刀 (D)，則可以從兩側切割。

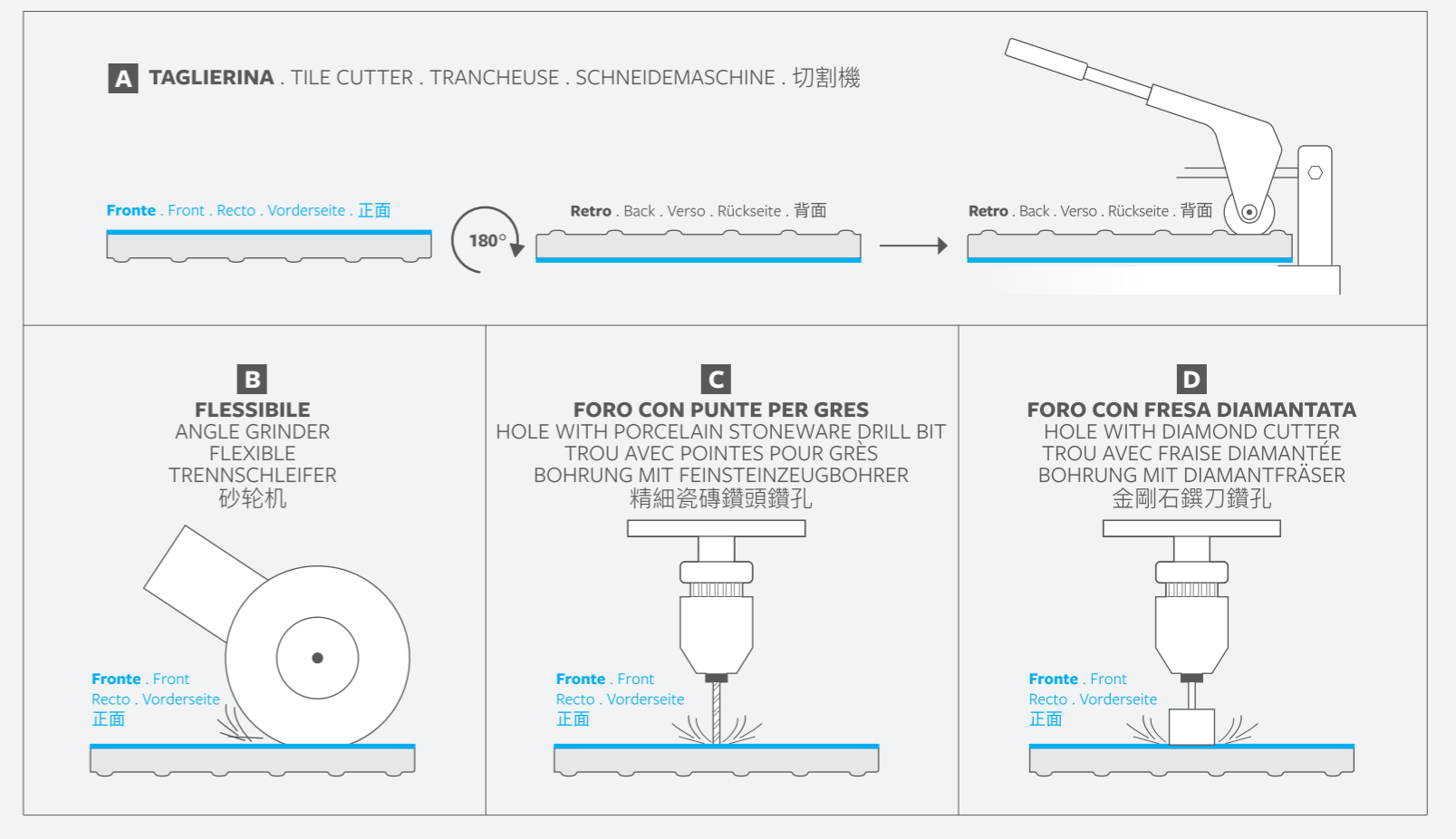

CATALOGHISTICA TECNICA

TECHNICAL CATALOGUES . CATALOGUES TECHNIQUES . TECHNISCHE KATALOGE



Inquadrare il qr code per scaricare i seguenti manuali tecnici

Scan the QR code to download the following technical manuals.

Scanner les code QR pour télécharger les manuels techniques suivants.

Scannen Sie die QR-Code, um die folgenden technischen Handbücher herunterzuladen.

Scopri la nuova App

MY TAGINA

Uno strumento di lavoro innovativo,
in esclusiva per i nostri clienti rivenditori

Discover the new App MY TAGINA:
an innovative work tool,
exclusively **for our reseller customers.**

A SET OF CLEAR,
INTUITIVE, FAST AND
EFFICIENT SERVICE,
AVAILABLE 24 HOURS A
DAY.

Découvrez la nouvelle application MY TAGINA :
un outil de travail innovant,
en exclusivité **pour nos clients revendeurs.**

UN ENSEMBLE DE
SERVICES, CLAIR,
INTUITIF, RAPIDE ET
EFFICACE, DISPONIBLE
24H/24.

Entdecken Sie die neue App MY TAGINA:
ein innovatives Arbeitswerkzeug,
exklusiv für **unsere Wiederverkäuferkunden.**

EINE REIHE VON
DIENSTLEISTUNGEN, KLAR,
INTUITIV, SCHNELL UND
EFFIZIENT, 24 STUNDEN
AM TAG VERFÜGBAR.

UN INSIEME DI SERVIZI, CHIARO, INTUITIVO, RAPIDO ED EFFICIENTE, DISPONIBILE 24 ORE SU 24.

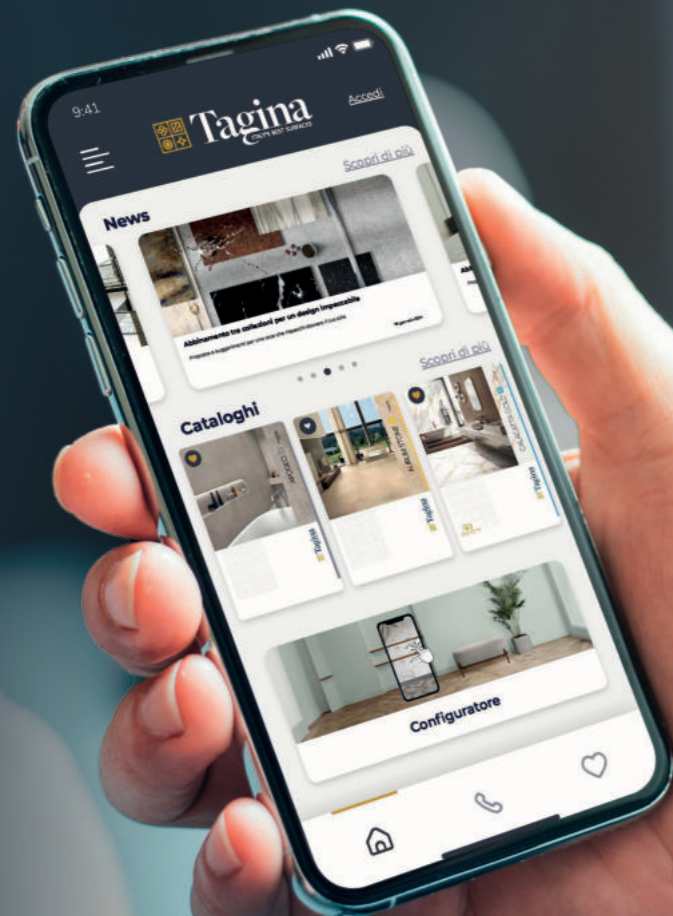

UN AMBIENTE DI LAVORO CON FUNZIONALITÀ AVANZATE PER LE ATTIVITÀ DI ACQUISTO, CONTROLLO E VENDITA, CONNESSO A TAGINA PER OTTENERE INFORMAZIONI IN TEMPO REALE.

A work environment with advanced features for purchasing, control and sales activities, connected to Tagina to obtain information in real time.

Un environnement de travail avec des fonctionnalités avancées pour les activités d'achat, de contrôle et de vente, connecté à Tagina pour obtenir des informations en temps réel.

Eine Arbeitsumgebung mit erweiterten Funktionen für Einkaufs-, Kontroll- und Verkaufsaktivitäten, verbunden mit Tagina, um Informationen in Echtzeit zu erhalten.

Scarica MyTagina e sperimenta un nuovo modo di interagire produttivamente e in tempo reale con l'azienda.

Download My Tagina and experience a new way to interact productively and in real time with the company.

Téléchargez My Tagina et expérimentez une nouvelle façon d'interagir de manière productive et en temps réel avec l'entreprise.

Laden Sie My Tagina herunter und erleben Sie eine neue Art, produktiv und in Echtzeit mit dem Unternehmen zu interagieren.



CERTIFICAZIONI
CERTIFICATIONS . CERTIFICATIONS . ZERTIFIZIERUNG



放射性水平 A 类



100% Made in Italy

Tagina S.p.a. si riserva il diritto di apportare modifiche, in qualsiasi momento e senza preavviso, al packaging, alle grafiche, ai colori e ai decori dei prodotti raffigurati nelle immagini.

Tagina S.p.a. reserves the right to make changes, at any time and without notice, to the packaging, graphics, colors, and decors of the products depicted in the images.

Tagina S.p.a. se réserve le droit d'apporter des modifications, à tout moment et sans préavis, à l'emballage, aux graphismes, aux couleurs et aux décors des produits représentés sur les images.

Tagina S.p.a. behält sich das Recht vor, jederzeit und ohne vorherige Ankündigung Änderungen an Verpackung, Grafiken, Farben und Dekoren der auf den Bildern abgebildeten Produkte vorzunehmen.

Tutte le dimensioni degli articoli in gamma, riportate sul catalogo, si intendono nominali.

All sizes of the items listed in the catalogue are nominal.

Toutes les dimensions des articles de la gamme, reportées sur le catalogue, s'entendent nominales.

Alle Größen der Produkte im Sortiment, die im Katalog angegeben sind, sind nominal.

Per le condizioni generali di vendita e le caratteristiche tecniche consultare www.tagina.it
General terms and Sales conditions and Technical features are available on our website www.tagina.it
Les Conditions général de vente et les Caractéristiques techniques sont disponibles sur le site web www.tagina.it
Allgemeine Verkaufsbedingungen und technische Eigenschaften sind auf unsere Website verfügbar: www.tagina.it

Tagina

ITALY'S BEST SURFACES



Tagina S.p.A.
Via Emilia Ponente, 925
48014 Castel Bolognese (RA) - Italy
Tel. +39 0545 197 7303 - tagina.it

Follow us

